

## MIRELLA-G2-S

~15° spot beam. Compatible with LEDiL HEKLA.

### TECHNICAL SPECIFICATIONS:

Dimensions	Ø 49.9 mm
Height	24.8 mm
Fastening	
Colour	metal
Box size	480 x 280 x 300 mm
Box weight	3.2 kg
Quantity in Box	336 pcs
ROHS compliant	yes ⓘ







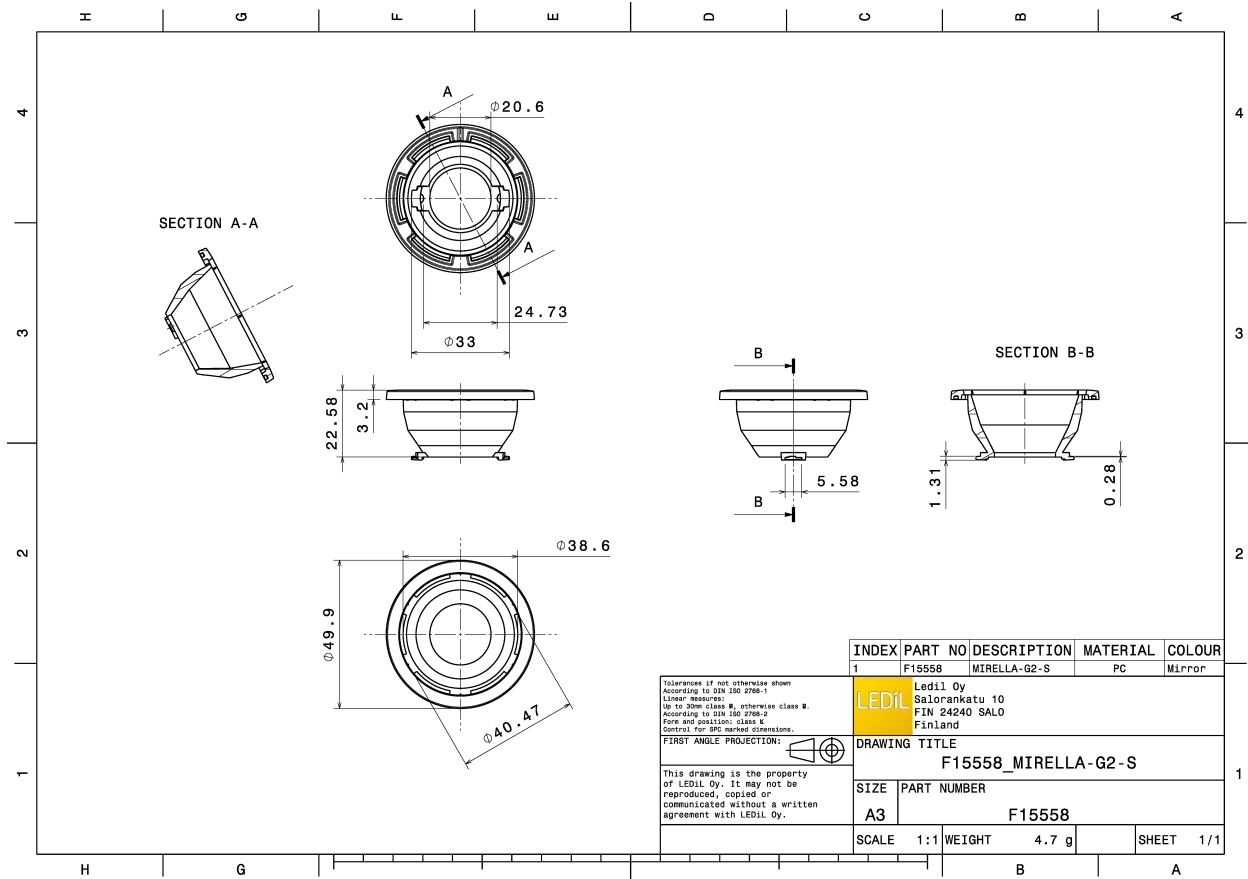

### MATERIAL SPECIFICATIONS:

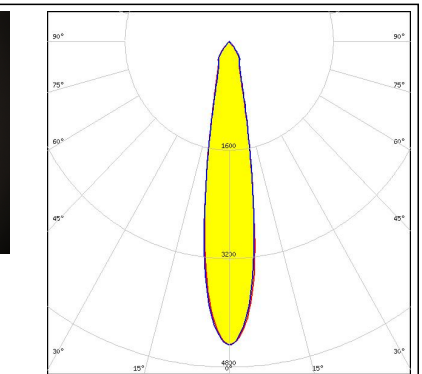
Component	Type	Material	Colour	Coating
MIRELLA-G2-S	Reflector	PC	metal	

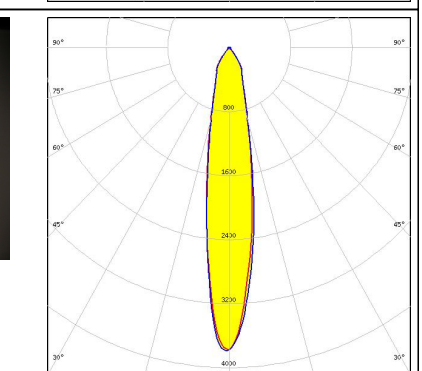

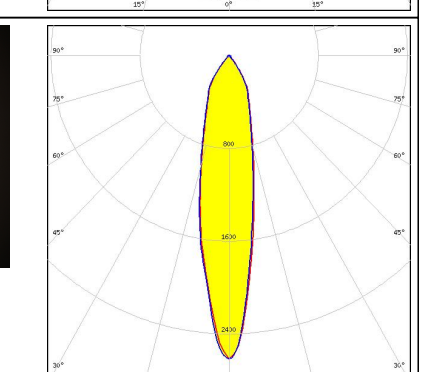
#### PHOTOMETRIC DATA (MEASURED):

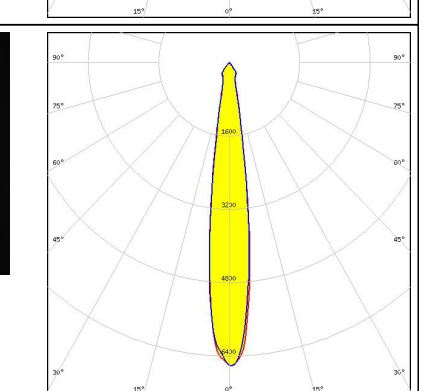
<p>bridgelux.</p> <p>LED VERO10</p> <p>FWHM 19.0°</p> <p>Efficiency 91 %</p> <p>Peak intensity 4.500 cd/lm</p> <p>Required components:</p> <p>LEDiL: F15616_HEKLA-SOCKET-F</p>		
<p>bridgelux.</p> <p>LED Vesta TW 9mm (12W)</p> <p>FWHM 18.0°</p> <p>Efficiency 85 %</p> <p>Peak intensity 3.800 cd/lm</p> <p>Required components:</p> <p>C16142_HEKLA-SOCKET-K</p> <p>Bender Wirth: 490 Typ L8</p>		
<p><b>CITIZEN</b></p> <p>LED CLC020 Series (Dim-To-Warm)</p> <p>FWHM 21.0°</p> <p>Efficiency 81 %</p> <p>Peak intensity 2.600 cd/lm</p> <p>Required components:</p> <p>LEDiL: C16142_HEKLA-SOCKET-K</p>		
<p><b>CITIZEN</b></p> <p>LED CLL02x/CLU02x (LES10)</p> <p>FWHM 15.0°</p> <p>Efficiency 88 %</p> <p>Peak intensity 6.600 cd/lm</p> <p>Required components:</p> <p>LEDiL: F15255_HEKLA-SOCKET-C</p>		

#### PHOTOMETRIC DATA (MEASURED):

#### CITIZEN

LED CLU700/701

FWHM 13.0°

Efficiency 91 %

Peak intensity 8.500 cd/lm

Required components:

C15743\_XTM-ADAPTER-50-B

LEDiL: F15255\_HEKLA-SOCKET-C

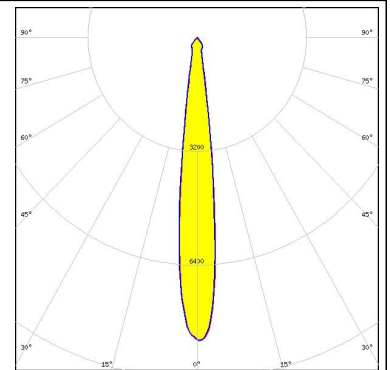

#### CITIZEN

LED CLU710/711

FWHM 19.0°

Efficiency 86 %

Peak intensity 3.400 cd/lm

Required components:

LEDiL: F15859\_HEKLA-SOCKET-I

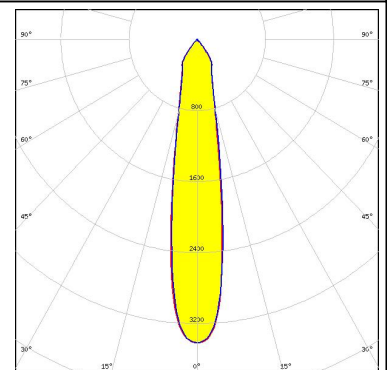
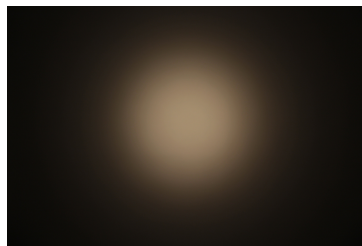

#### CREE

LED CXA/B 13xx

FWHM 12.0°

Efficiency 93 %

Peak intensity 9.200 cd/lm

Required components:

C13723\_MIRELLA-RZL

LEDiL: F15956\_HEKLA-SOCKET-J

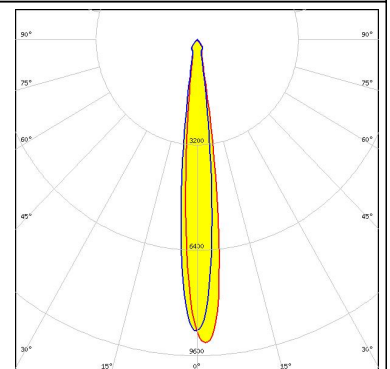
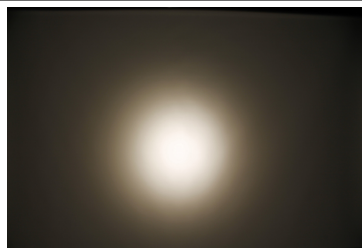

#### CREE

LED CXA/B 15xx

FWHM 18.0°

Efficiency 93 %



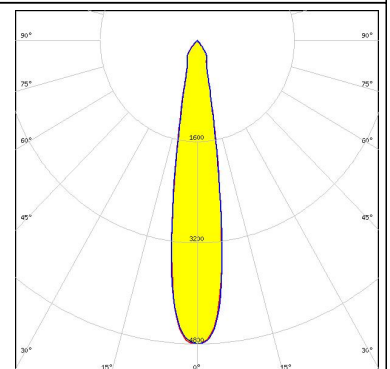

Peak intensity 4.800 cd/lm

Required components:

LEDiL: F15256\_HEKLA-SOCKET-D

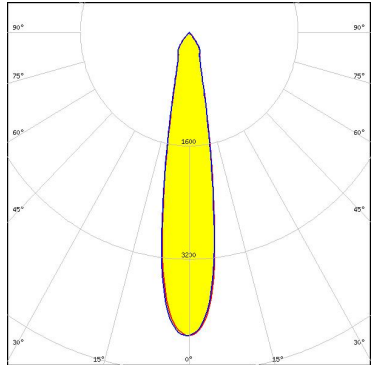
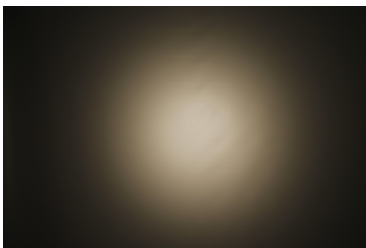
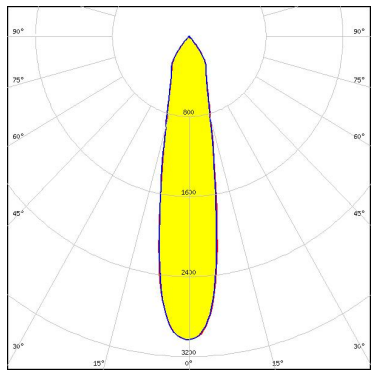

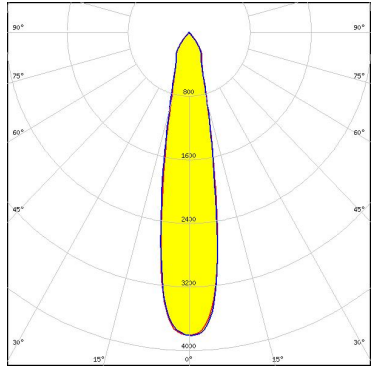
#### PHOTOMETRIC DATA (MEASURED):

<p><b>LUMILEDS</b></p> <p>LED LUXEON CoB 1202/1203</p> <p>FWHM 19.0°</p> <p>Efficiency 90 %</p> <p>Peak intensity 4.300 cd/lm</p> <p>Required components: LEDiL: F15858_HEKLA-SOCKET-H</p>		
<p><b>LUMINUS</b></p> <p>LED CXM-9</p> <p>FWHM 22.0°</p> <p>Efficiency 88 %</p> <p>Peak intensity 3.000 cd/lm</p> <p>Required components: LEDiL: F15255_HEKLA-SOCKET-C</p>		
<p><b>OSRAM</b> Opto Semiconductors</p> <p>LED Soleriq S9</p> <p>FWHM 21.0°</p> <p>Efficiency 91 %</p> <p>Peak intensity 3.800 cd/lm</p> <p>Required components: C12479_MIRELLA-DL LEDiL: F15255_HEKLA-SOCKET-C</p>		
<p><b>SAMSUNG</b></p> <p>LED LC010C G2</p> <p>FWHM 13.0°</p> <p>Efficiency 88 %</p> <p>Peak intensity 6.400 cd/lm</p> <p>Required components: LEDiL: F15255_HEKLA-SOCKET-C</p>		

## PHOTOMETRIC DATA (MEASURED):

### SAMSUNG

LED LC020C  
FWHM 18.0°  
Efficiency 90 %  
Peak intensity 4.400 cd/lm

Required components:

LEDiL: F15848\_HEKLA-SOCKET-G

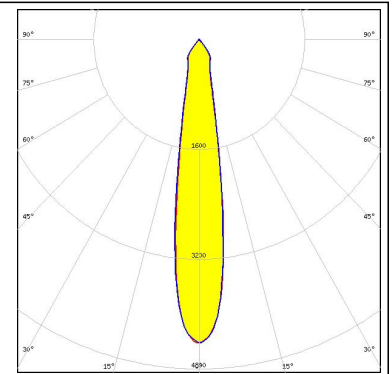

#### PHOTOMETRIC DATA (SIMULATED):



LED VERO13  
 FWHM 25.0°  
 Efficiency 82 %  
 Peak intensity 2.300 cd/lm  
 Required components:  
 LEDiL: C16142\_HEKLA-SOCKET-K

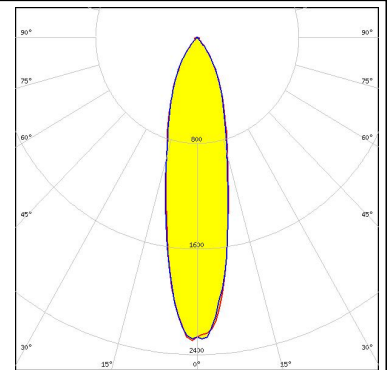

LED CMA1516  
 FWHM 19.0°  
 Efficiency 89 %  
 Peak intensity 4.240 cd/lm  
 Required components:  
 LEDiL: F15256\_HEKLA-SOCKET-D

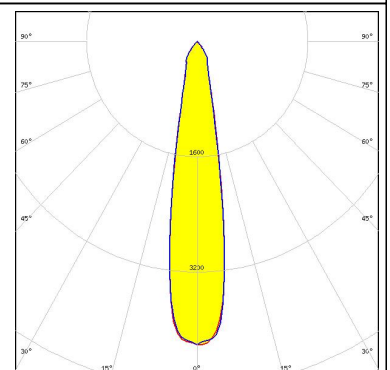

LED COB T-Type  
 FWHM 14.0°  
 Efficiency 88 %  
 Peak intensity 7.360 cd/lm  
 Required components:  
 LEDiL: F15848\_HEKLA-SOCKET-G

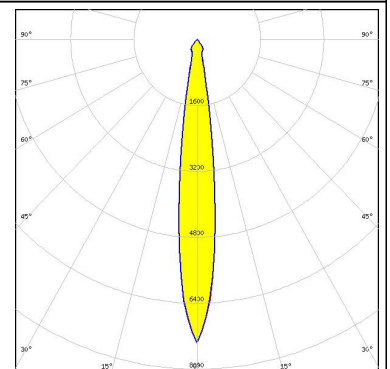

LED SLE G6 LES10  
 FWHM 18.0°  
 Efficiency 90 %  
 Peak intensity 4.600 cd/lm  
 Required components:  
 LEDiL: F15255\_HEKLA-SOCKET-C

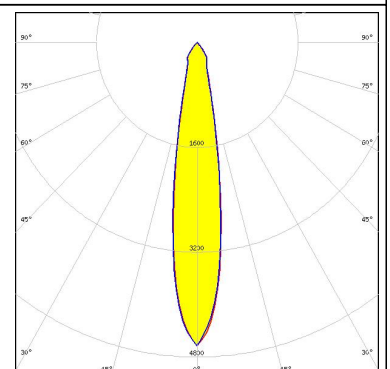

#### GENERAL INFORMATION:

NOTE: The typical beam angle will be changed by different color, chip size and chip position tolerance. The typical total beam angle is the full angle measured where the luminous intensity is half of the peak value.

Due to use of high power COB's with this product, special attention to proper thermal design is highly recommended. LEDiL has no liability for direct, indirect or consecutive damages arising from the LEDiL products being used outside of the recommended temperature range.

#### MATERIALS:

As part of our continuous research and improvement processes, and to ensure the best possible quality and availability of our products, LEDiL reserves the right to change material grades without notice.

#### PRODUCT DATA USER AGREEMENT AND DISCLAIMER:

The measured data in the provided downloadable LEDiL Product Datasheets and Mechanical 2D-Drawings is rounded and provided as reference for planning. LEDiL Oy's optical specifications have been verified by conducting performance testing of the products in accordance with the company's quality system. The reported data are averaged results of multiple measurements with typical variation. LEDiL Oy reserves the right to without prior notification make changes and improvements to its products.

LEDiL Oy assumes neither warranty, nor guarantee nor any other liability of any kind for the contents and correctness of the provided data. The provided data has been generated with highest diligence but the provided data may in reality not represent the complete possible variation range of all intrinsic parameters. Therefore, in certain cases a deviation from the provided data could occur.

LEDiL Oy reserves the right to undertake technical changes of its products without further notification which could lead to changes in the provided data. LEDiL Oy assumes no liability of any kind for the possible deviation from any provided data or any other damage resulting from the usage of the provided data.

The user agrees to this disclaimer and user agreement with the download or usage of the provided files.

#### LEDiL Oy

Joensuunkatu 13  
FI-24240 SALO  
Finland

#### LEDiL Inc.

228 West Page Street  
Suite D  
Sycamore IL 60178  
USA

#### Local sales and technical support

[www.ledil.com/where\\_to\\_buy](http://www.ledil.com/where_to_buy)

#### Shipping locations

Salo, Finland  
Hong Kong, China

#### Distribution Partners

[www.ledil.com/where\\_to\\_buy](http://www.ledil.com/where_to_buy)