

EDH, Aluminum Electrolytic, 105C, 220 uF, 20%, 10 VDC, -40/+105C

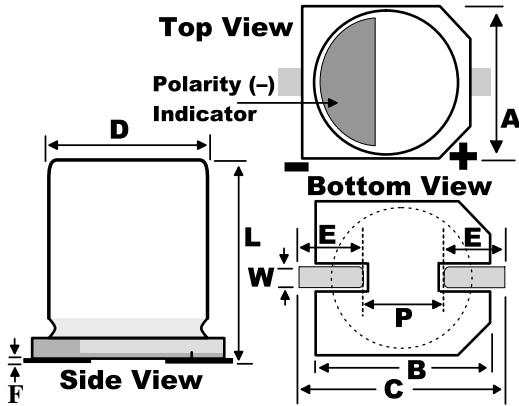

Dimensions	
D	6.3mm +/-0.5mm
L	7.7mm +/-0.3mm
W	0.65mm +/-0.1mm
F	0.3mm MAX
A	6.6mm +/-0.2mm
B	6.6mm +/-0.2mm
C	7.8mm MAX
E	2.6mm +/-0.2mm
P	1.8mm +/-0.2mm

Packaging Specifications	
Packaging:	T&R
Packaging Quantity:	1000

General Information	
Supplier:	KEMET
Series:	EDH
Dielectric:	Aluminum Electrolytic
Style:	SMD Can
Description:	Surface Mount, Aluminum Electrolytic
RoHS:	Yes
Lead:	V-Chip

Specifications	
Capacitance:	220 uF
Capacitance Tolerance:	20%
Voltage DC:	10 VDC, 13 VDC (Surge)
Temperature Range:	-40/+105C
Rated Temperature:	105C
Life:	2000 Hrs
Dissipation Factor:	30.00% 120Hz 20C
Ripple Current:	120 mAmps (120Hz 105C)
Leakage Current:	22 uA (2min 20C)
Impedance Ratio at -25C:	3
Impedance Ratio at -40C:	6
High Temperature Solder:	Yes