

NEW

Proximity Sensors

DC 3-Wire Models

E2E NEXT Series

OMRON

Exceptional
sensing
range*

Enables easier and
standardized design

9 mm

[Quadruple distance model of M12 sized]

 IO-Link

* Based on December 2018 OMRON investigation.

Enables easier and standardi previously not possible

PREMIUM Model

Easy design

Standardized design

Exceptional sensing range*¹ **9** ^[M12] mm*²

The PREMIUM Model, which has a longer detection range compared to previous models, allows for more spacious designs with less risk of contact. It also enables you to standardize your designs by letting you adopt a single one-size model instead of multiple models of different sizes.

*1. Based on December 2018 OMRON investigation.

*2. Quadruple distance models of M12 sized

Quadruple distance model

9 mm [M12]

Triple distance model

6 mm [M12]

P.4-7

BASIC Model

In addition to our HIGH SPEC Models, we also offer mid/short-distance BASIC Models, to meet various facility design requirement specifications.

Double distance model

4 mm [M12]

Single distance model

2 mm [M12]



zed designs



New standards for usability

Early error detection

1 location, all new E2E Sensors can be monitored with IO-Link  **IO-Link**

P.8

Quick recovery

10 second replaceable with e-jig (adaptor)

P.10

360 degree view with high visibility LED indicator

P.10

Less unexpected facility stoppages

Strong resistance to cutting oil **2**-year oil resistance*3

P.12

*3. Pre-wired models and pre-wired connector models.

Easy design

Equipped with exceptional sensing range* to enable collision-free sensor installation

Enables designs with more distance between the sensor and the sensing object, thereby reducing unexpected facility stoppages due to collision and false detection, which occurred with previous proximity sensors.

Previous models

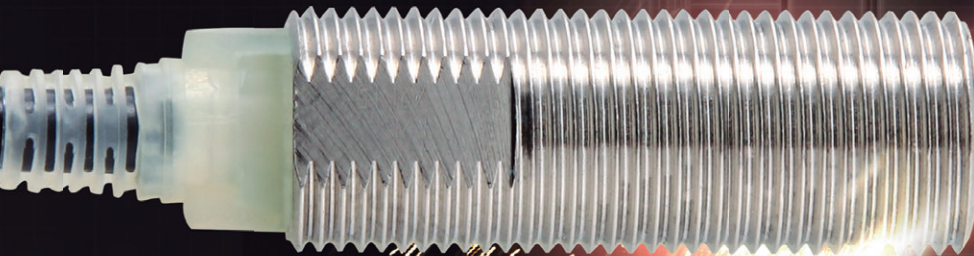

E2E NEXT

Exceptional
sensing range*

[Quadruple distance
models of M12 sized]
9 mm

* Based on December 2018 OMRON investigation.

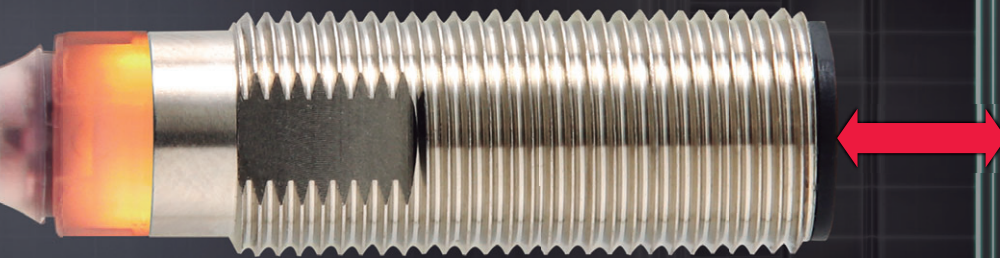

Stable detection without collision

Allows for more spacious design with less risk of contact

With previous models, to avoid false detections, you were forced to adopt sensor installation designs that risked contact. The E2E NEXT PREMIUM Proximity Sensor can detect accurately from a greater distance, which means you can adopt designs with more space and less risk of contact.



Approximately double the sensing distance of previous models

Sensing distance comparisons (Quadruple distance models)

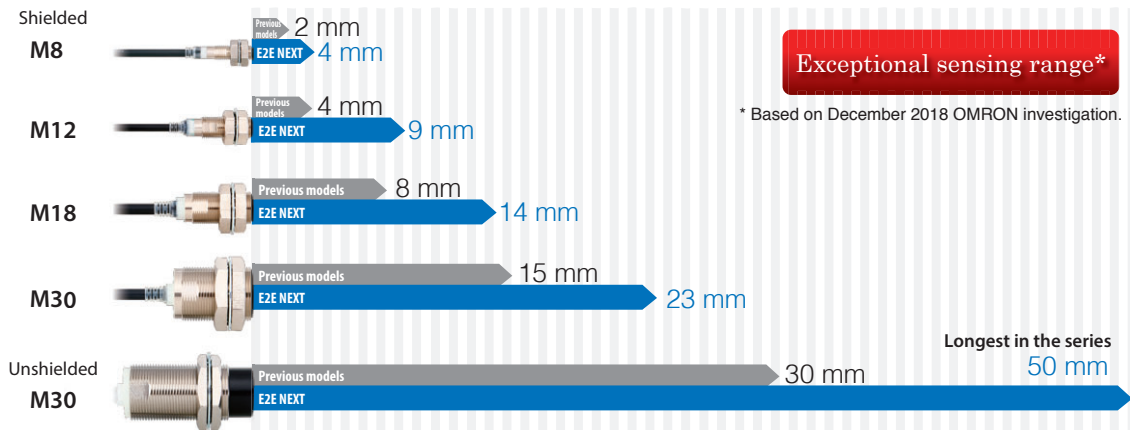

Less false detection even when a stationary gets away from the sensor due to equipment vibration

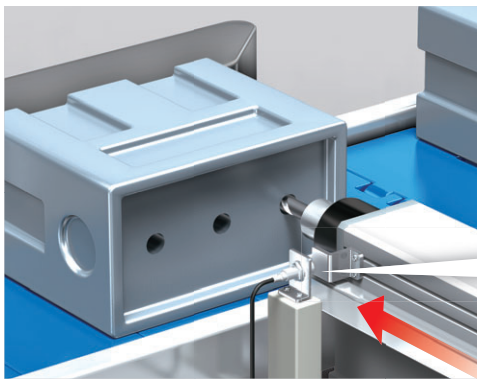

Spindle presence detection

Previous models

The equipment vibration widens the distance between a stationary and a sensor to cause false detection and facility stoppages.

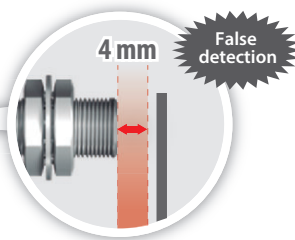

E2E NEXT

Long-distance detection enhances the degree of the detection margin. **Stable detection even when a stationary gets away.**

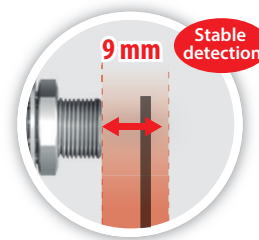

* Quadruple distance models of M12 sized

PROX3 hybrid circuitry with Thermal Distance Control 2 eliminates ambient temperature influence to enable extended sensing ranges.

Proximity sensors with longer sensing distance require increased sensitivity. However, with the increased sensitivity, temperature changes will have bigger influence in sensing distance, and differences between individual sensors will be bigger. E2E NEXT Proximity Sensors (3-wire models) solve these issues by newly implementing Thermal Distance Control 2, a technology to enable extended sensing ranges. It enables in-line measurements of each sensor's temperature characteristics, using multiple temperature points, in IoT-enabled production processes. The optimal correction values are then calculated based on our unique algorithm. The values are written into the analog digital hybrid IC (PROX3) for shipping to minimize differences between sensors and the influence of temperature changes that may occur in the customer's environments.

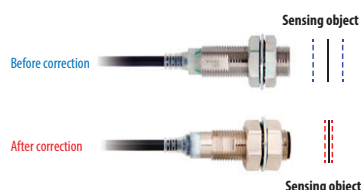

Patent Pending Thermal Distance Control 2 technology reduces the extent of error

Sensing distance fluctuation due to ambient temperature

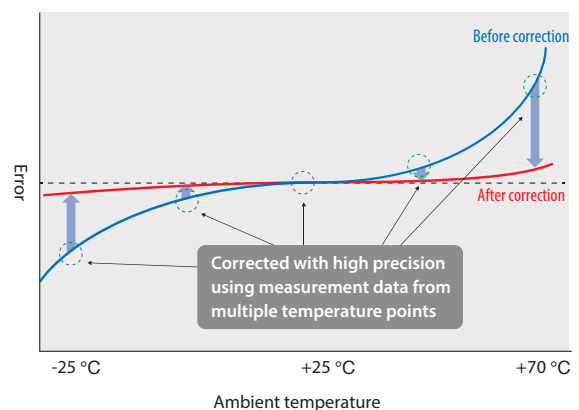

Standardized
design

Exceptional sensing range*¹

allows you to standardize your design with a single one-size model

Ensures equivalent sensing distance while being one size smaller than previous models. Equipment and facilities formerly designed to use sensors of multiple sizes can now be designed to use sensors that are all the same size, allowing you to standardize your designs.

Case where either M12 or M18 is used depending on sensing distance

Previous models Two different types of hole designs were required for the sensing distance of 4 mm and 8 mm.

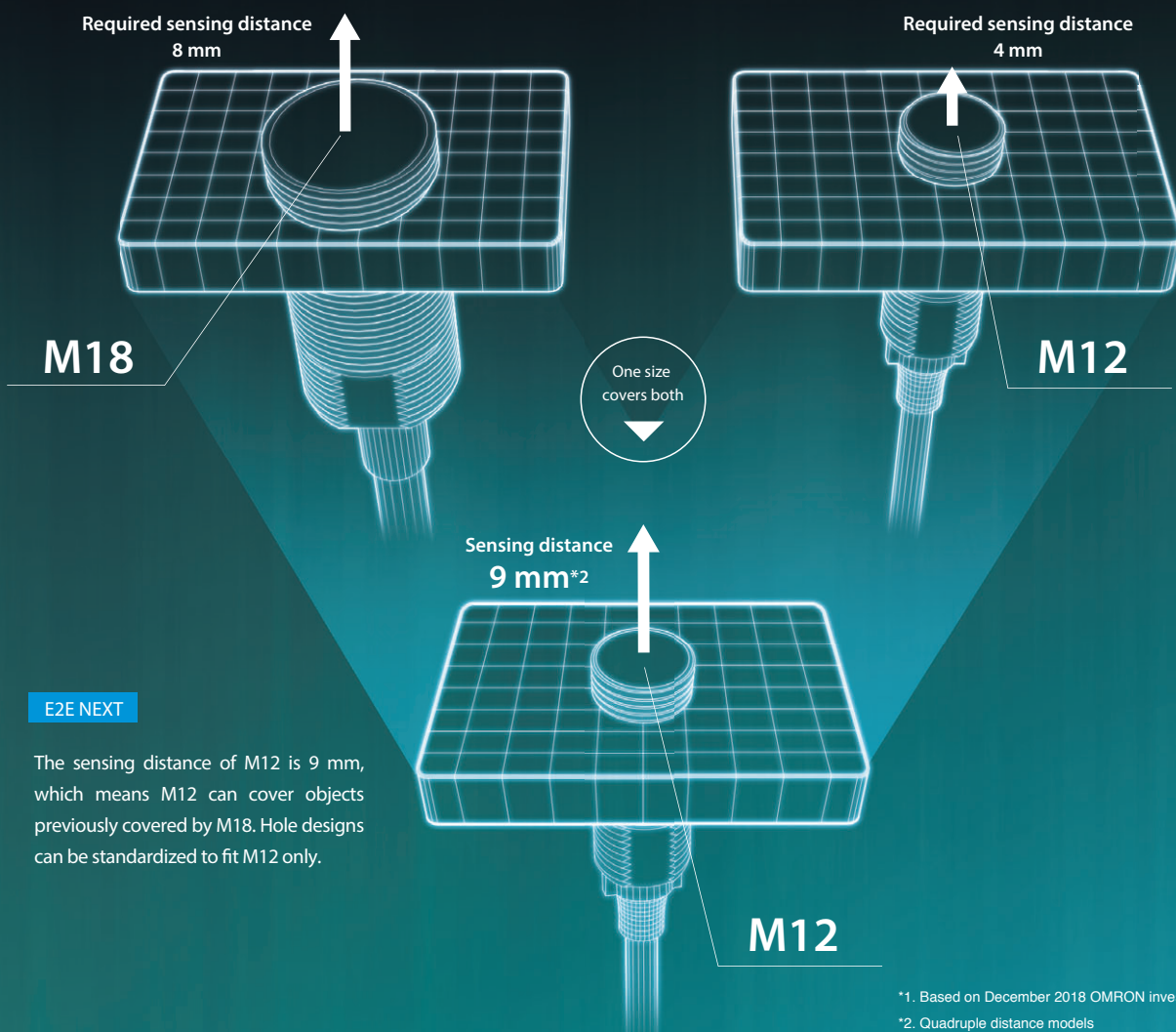

Four types of M12 size sensors are available to meet the need for variable sensing distances for different installation sites.

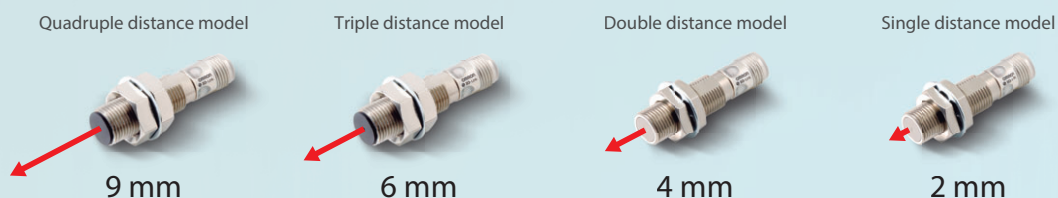

Easy to install, even where space is limited

E2E NEXT PREMIUM Model Proximity Sensors ensure equivalent sensing distance while being one size smaller than previous models, allowing you to install them in spaces where conventional sensors were too big to fit.

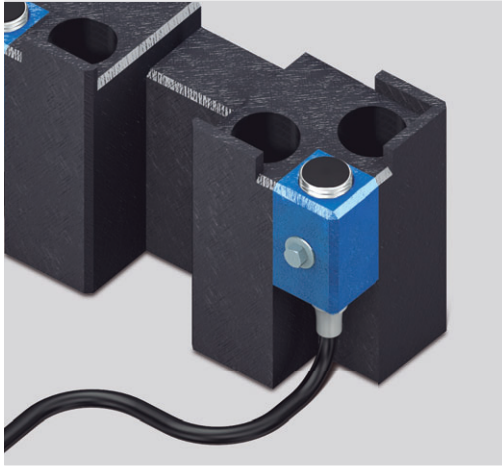

Previous models Proximity sensors could not be installed due to limited space.

E2E NEXT They can be installed due to limited space.

One size smaller to allow you to install proximity sensors where space is limited.

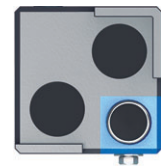
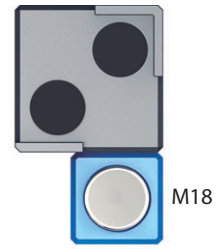

Note: When installing proximity sensors, make sure to factor the influence of surrounding metal into your designs. (Refer to •Influence of Surrounding Metal upon Design on page 62 and page 80 for details.)

■ One size smaller than previous models

Size comparisons between models with equivalent sensing distance ("E2E NEXT" refers to quadruple distance models)

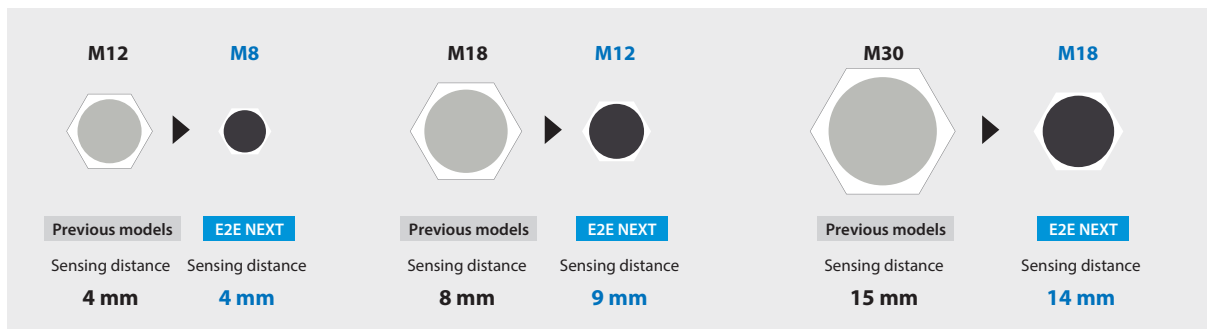

Unifying the model types to reduce the number of parts kept in inventory.

Previous models Two models (M12 and M18) stocked

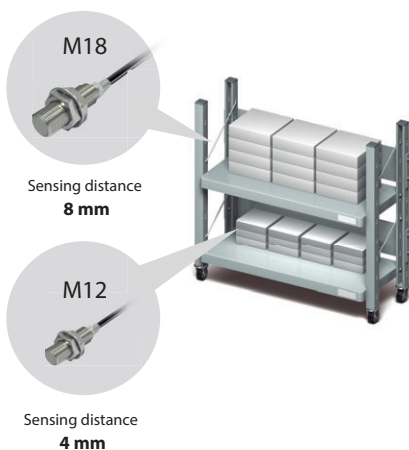

E2E NEXT The extended range of the new sensors allows you to reduce the sensor size from M18 down to M12.

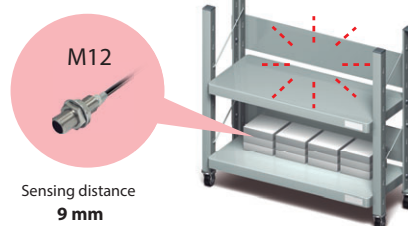

New standards for usability | Early error detection

Enables facility designs that allow for early discovery of the site and substance of failure

Less time required from failure to recovery
(MTTR: Mean Time To Recovery).

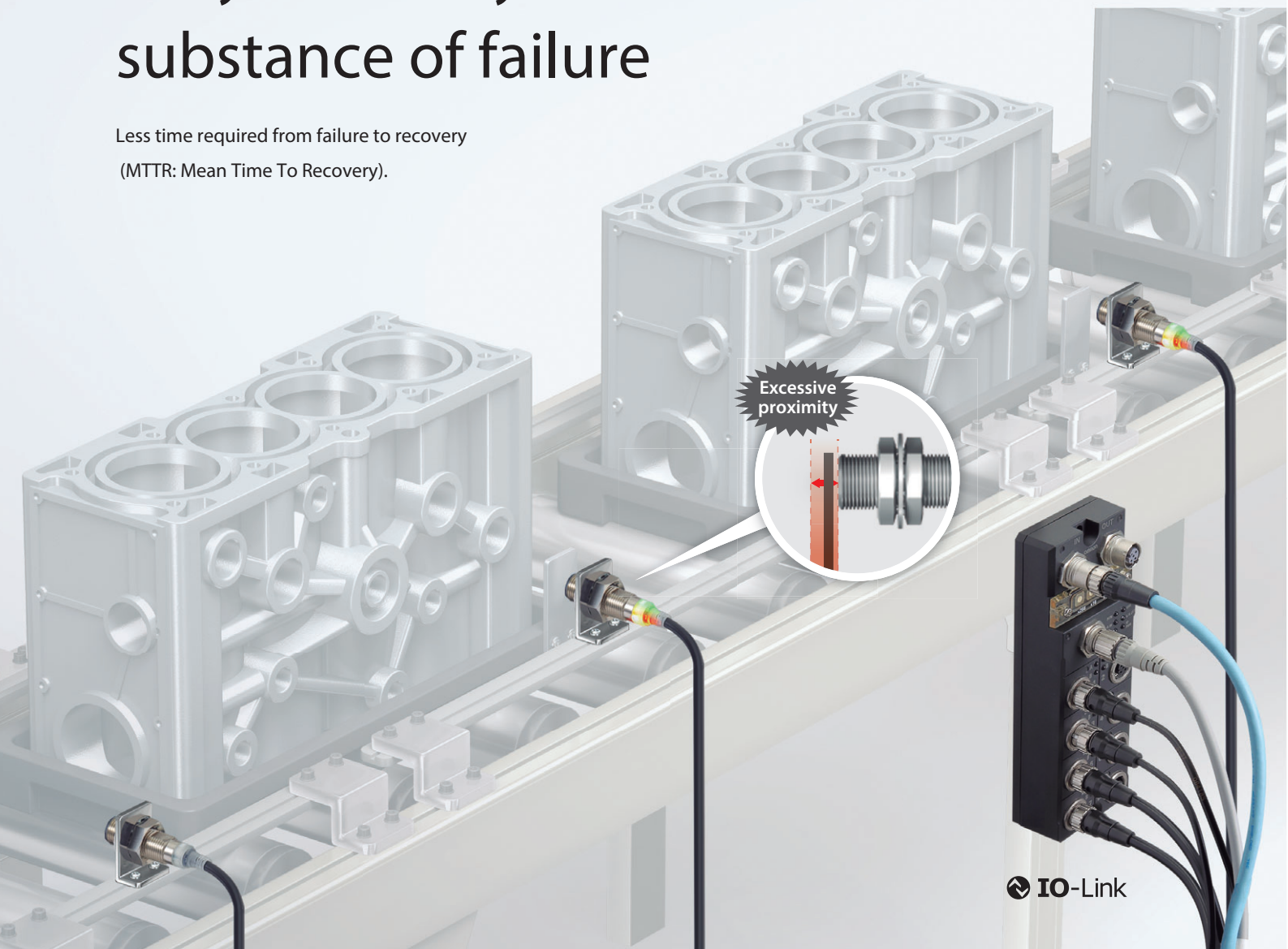

 IO-Link

Detects sensor failures through two output types, NO and NC

Enables failure discovery by wiring two outputs, NO and NC.

When NO cable is disconnected

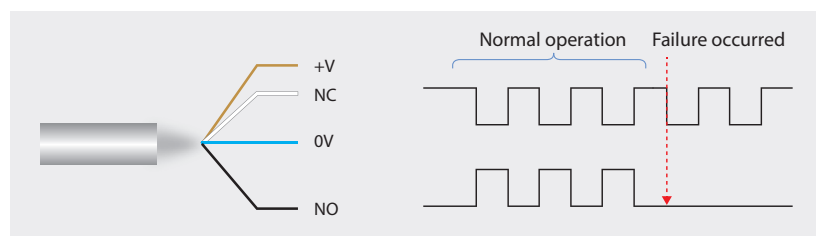

Enables real-time identification of the site and substance of sensor failure from a single location

By using the IO-Link Master to connect proximity sensors to your controller, you can use your monitor (HMI) for early discovery of the site and substance of proximity sensor failures.

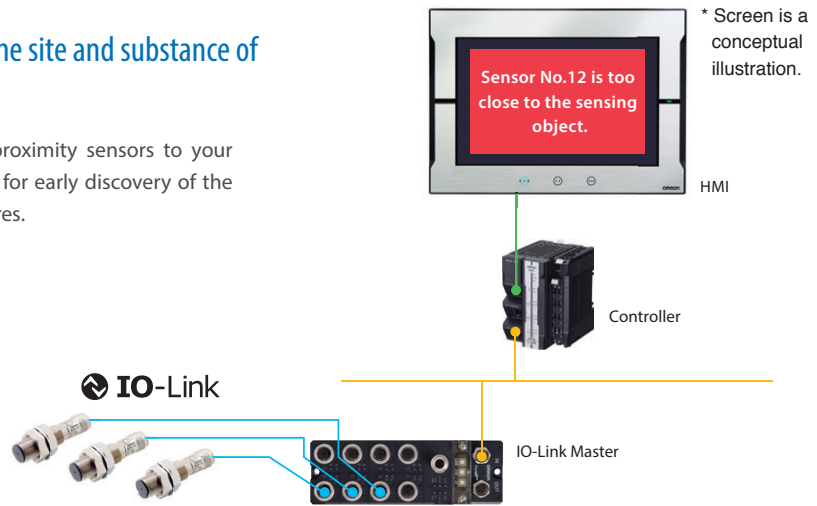

Enables predictive maintenance through condition monitoring

Connecting sensors with controllers using IO-Link Master enables to send information necessary for stable operation to host devices. This enables condition monitoring and failure detection of sensors, which in turn contribute to predictive maintenance of equipment and facilities. You can also increase the productivity of your facility by accumulating information in databases and feeding analysis results back to equipment on the site.

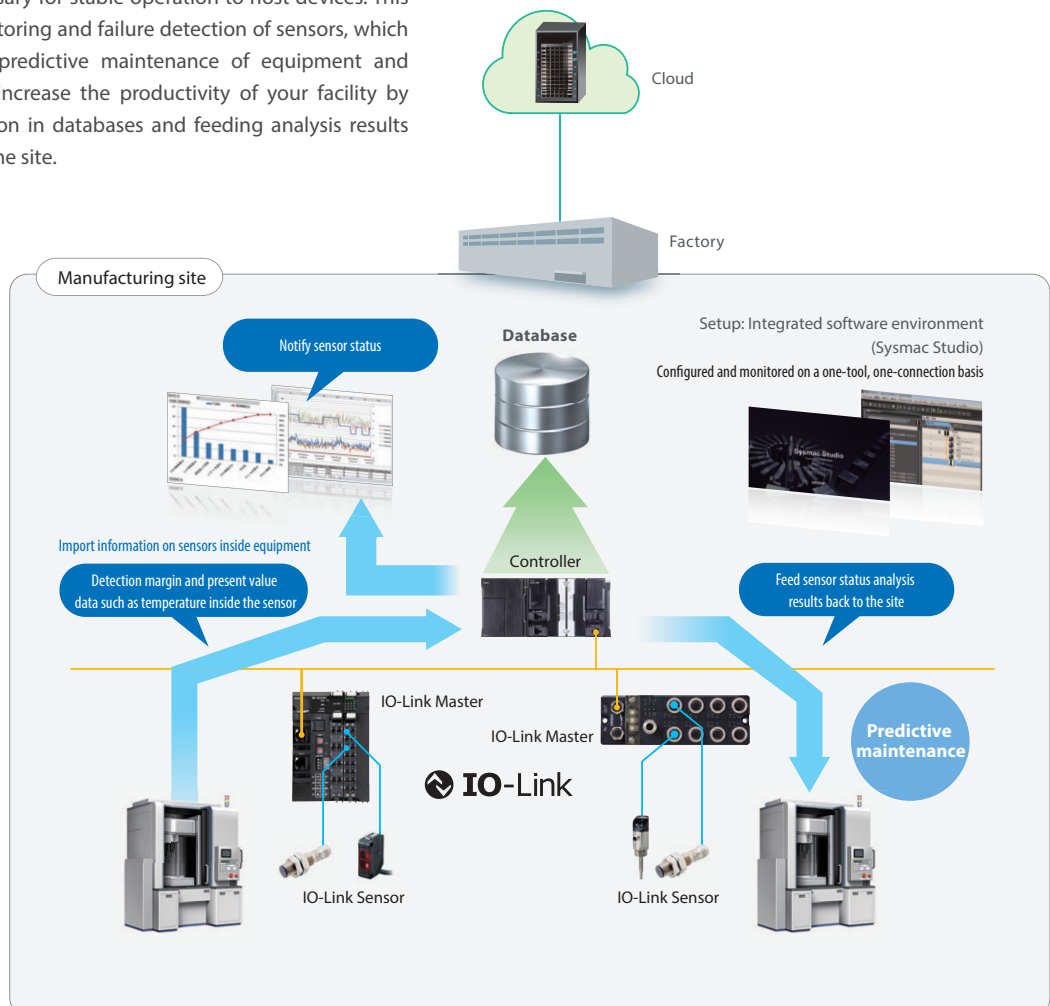

New standards for usability | Quick recovery

Enables facility designs that allow for quick recovery in case of failure

Less time required from failure to recovery
(MTR: Mean Time To Recovery).

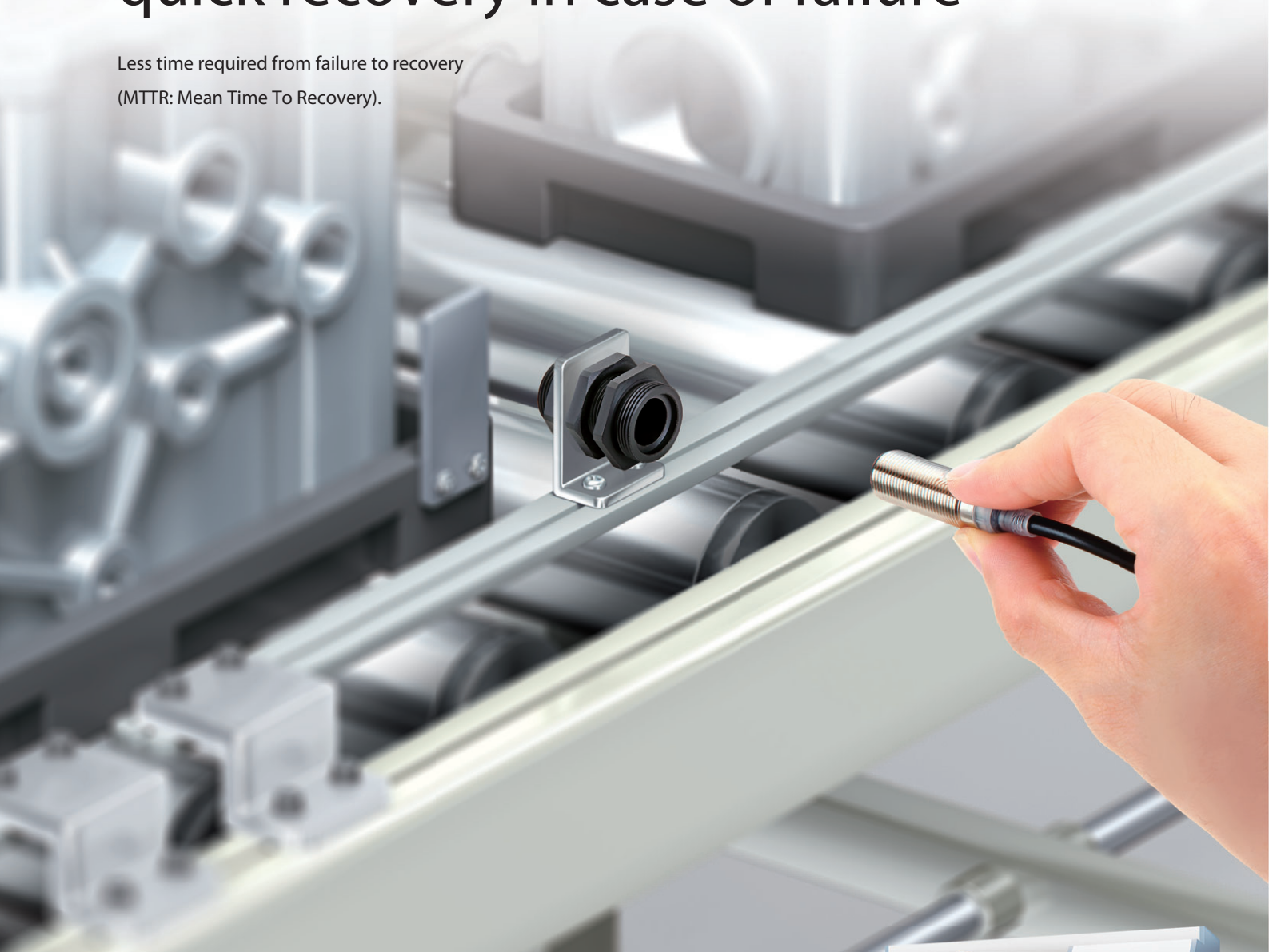

All around visible high-brightness LED indicator

Adopts high-brightness LED that is more luminous and visible than those in previous models. The indicator is visible from all angles, reducing the time required for operation checks after sensor replacement.

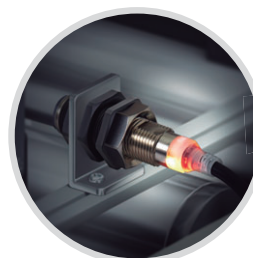

Visible even in areas deep inside the equipment,
allowing for quicker replacement



Replacements in as little as 10 seconds* using e-jig

Using e-jig eliminates the need for adjustment so that anyone can install in the same position.

Previous models

A lot of time required to adjust to the optimum distance.
Adjustment position varies depending on the worker's skill and makes detection unstable.

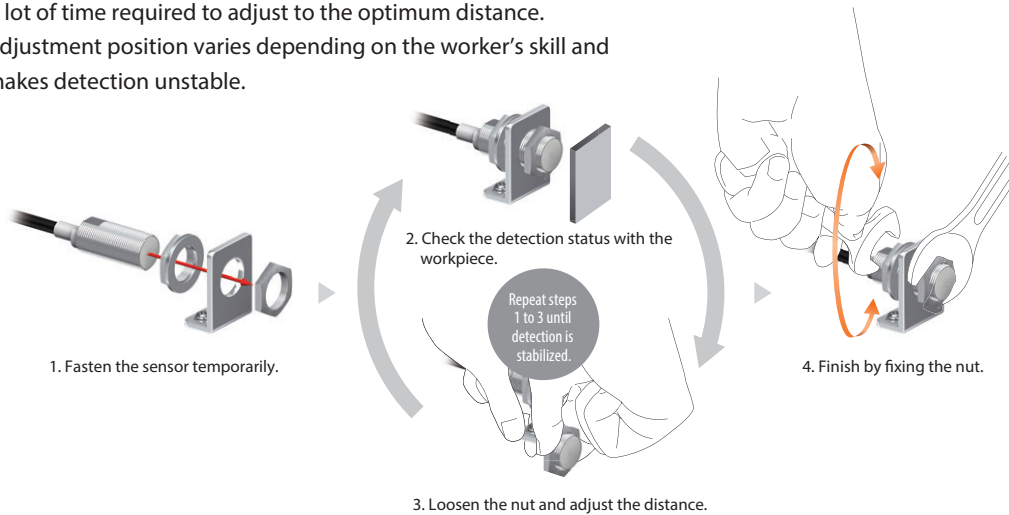

E2E NEXT

Replacement time reduced significantly to approx. **10 sec.***

Eliminating the need for adjustment allows for installation in the same position by any worker.

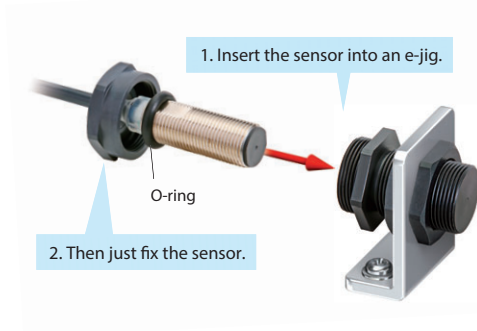

Patent Pending

The O-ring blocks the ingress of foreign matter, including cutting oil, into the e-jig and ensures positioning precision (IP67G).

* Time required to adjust the distance when installing a sensor.
Based on OMRON investigation.

Easily upgrade existing facilities to enable "10-second* proximity sensor replacements"

The HIGH SPEC Model's sensing distance is approximately twice that of previous models. For example, the sensing distance of the quadruple distance model of M12 sized is 9 mm, which is about the same as conventional M18 models. Using these sensors together with the e-jig allows you to easily upgrade your existing facilities so that you can replace their sensors in just 10 seconds.*

1. Dismount the M18 proximity sensor from the existing facility.

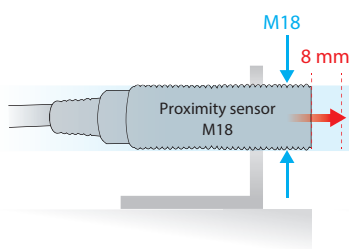

2. Mount an M18-sized e-jig.

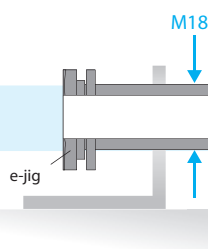

3. Insert an E2E NEXT Series M12 Proximity Sensor into the e-jig.

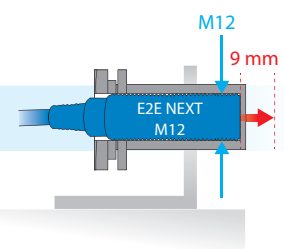

New standards for usability | Less unexpected facility stoppages

Excellent environmental resistance enables robust facility design

Reduces sudden facility stoppages by reducing the number of failures, even in severe environments.

Unexpected component failures:
Approx. **30%** are caused by cutting oil.

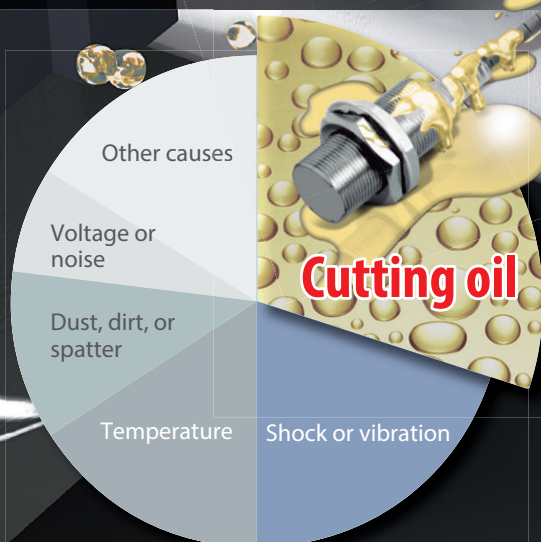

■ Environmental Causes of Component Failures

(Based on June 2016 OMRON investigation.)

Cables with enhanced oil resistance shut out cutting oil for 2 years*

Our new PVC compound protects against damage caused by swelling, deterioration or cracking, preventing oil from seeping into and destroying internal circuits. Designed to resist oil ingress for up to two years.

Two years* of stable operation verified by OMRON's unique evaluation technology

Previous models

Cables damaged by cutting oil



PUR cables get cracks under environments where water-soluble cutting oil is used.

E2E NEXT

Verified 2-year oil resistance,* based on IP67G and OMRON's oil-resistant component evaluation standards



OMRON's E2E NEXT Series Proximity Sensors use PVC cables with enhanced oil resistance, and have been evaluated according to IP67G of JIS C 0920, and also OMRON's own, even stricter evaluation standards for oil-resistant components.

Oil resistance: 2 years*

IP67G	
Oil type	N3 (water-insoluble cutting oil)
Evaluation time	48 hours
Evaluation temperature	Room temperature
Dilution concentration	—
Criteria	Appearance and performance

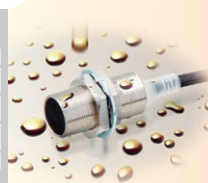

(Illustration)

OMRON's Oil-resistant Component Evaluation Standards	
Oil type	A1 (water-soluble cutting oil)
Evaluation time	1,000 hours of machining
Evaluation temperature	55 °C
Dilution concentration	Undiluted
Criteria	Appearance, performance, and no label text loss

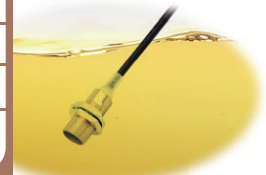

(Illustration)

Two years* of stable operation verified for pre-wired connector models as well, using similar oil resistance tests

- Delivers 2-year oil resistance* by adopting technologies unique to OMRON and PVC cables with enhanced oil resistance. **Patent Pending**
- Smartclick connector cables block the ingress of cutting oil, and with the same torque, no matter who connects them.



Smartclick is a registered trademark of OMRON Corporation.

Fit with just 1/8 of a turn and a single click!

For machining processes where the amount of splashing cutting oil is large, oil-resistant Proximity Sensors E2ER/E2ERZ

Oil Resistance: 4 years



Cat. No. Y215

*Applicable oil types: specified in JIS K 2241:2000

"2-year oil resistance" refers to median values (=Typical values) of the product designs and the oil-resistance performance evaluation results. Products to be shipped will have around 2 years of oil resistance; actual oil resistance will vary depending on the product.

*The pre-wired connector model has a verified oil resistance of 2 years when mated with XS5 NEXT series round oil-resistant connectors. This value has not been verified for connector models(M1/M3/M5).

IP69K compliant for water resistance and wash resistance

IEC 60529 compliant. Ensures water resistance during hot pressure washing, where equipment is washed intensively with high-pressure water or steam. (8,000 to 10,000 kPa pressure, 80°C hot water, 30 seconds for each angle)

E2E/E2EQ NEXT Series

Selection Guide

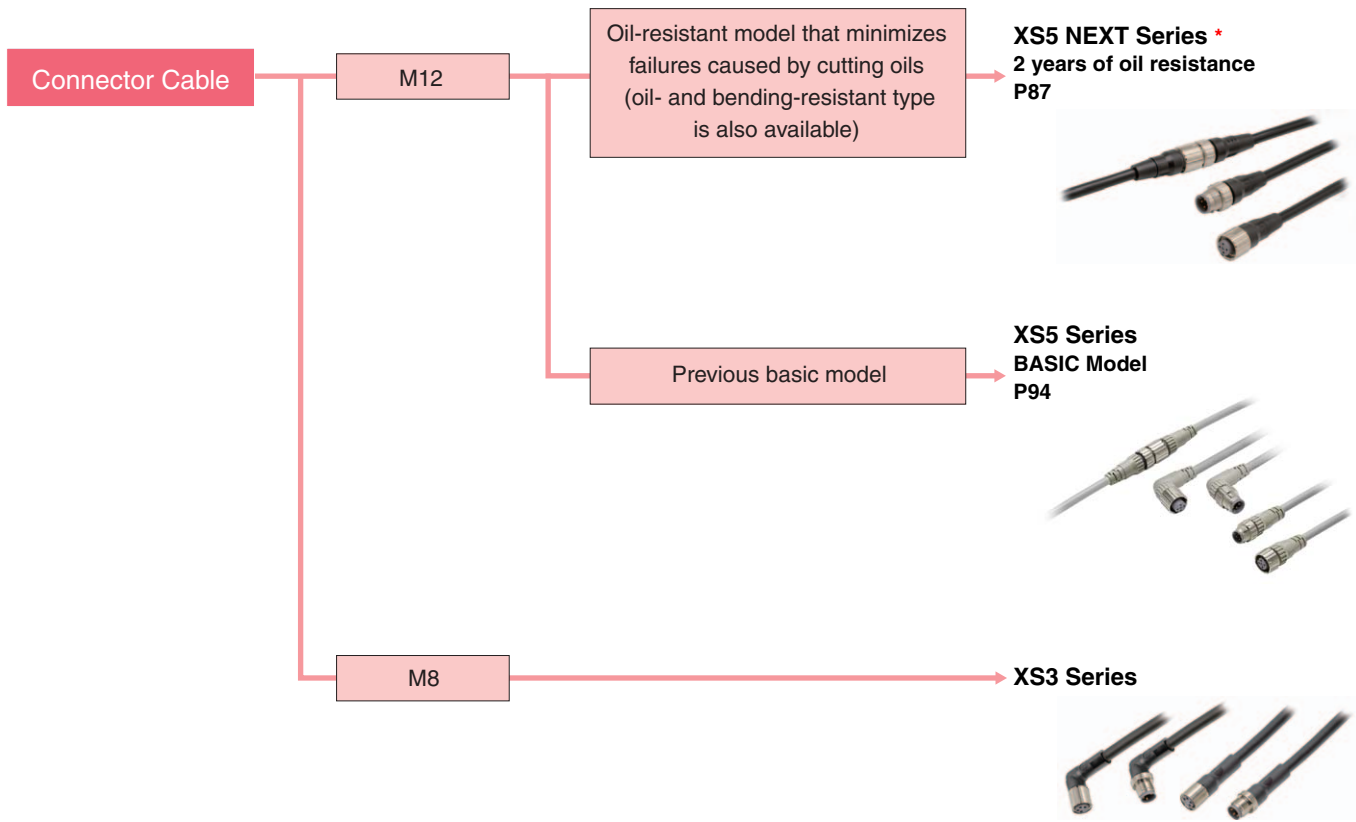
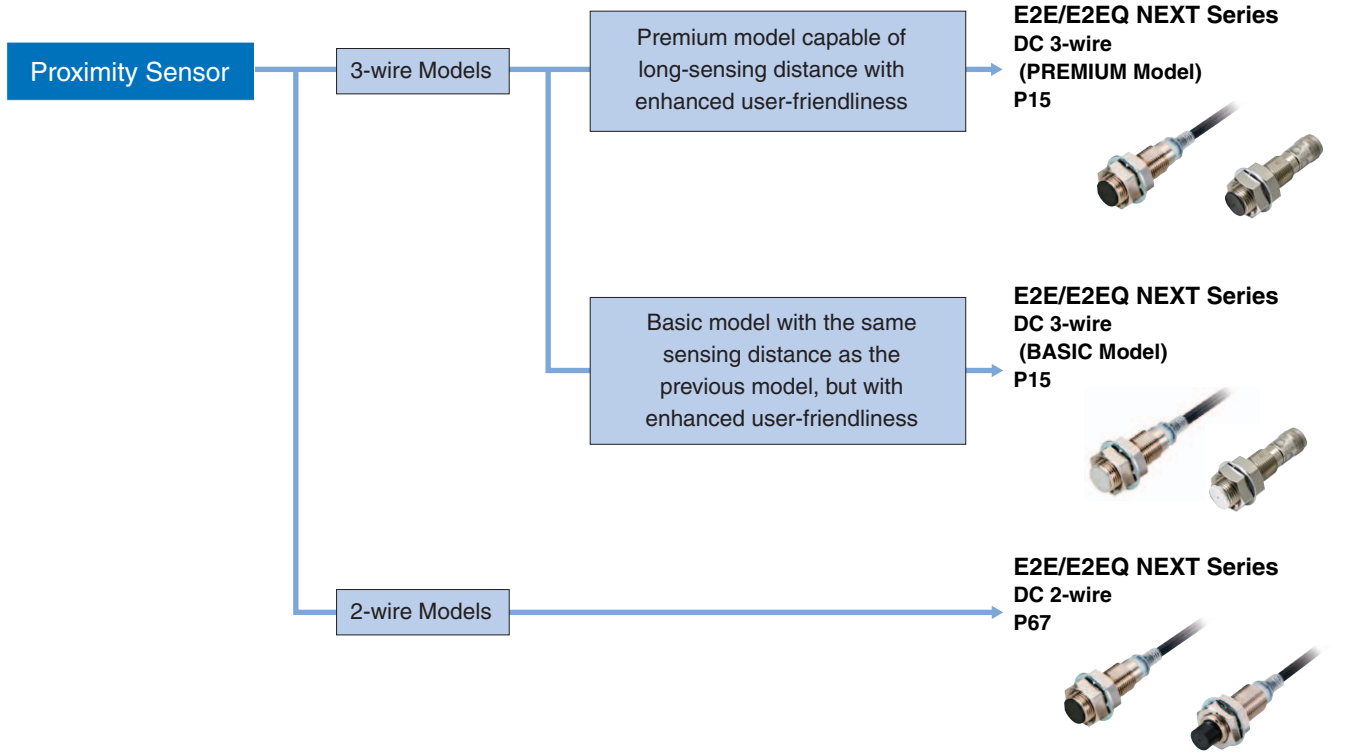

Note: For details of XS3 Series, refer to *XS3 Series Datasheet* (No. G147).

* Applicable oil types: specified in JIS K 2241:2000
 "2-year oil resistance" refers to median values (=Typical values) of the product designs and the oil-resistance performance evaluation results. Products to be shipped will have around 2 years of oil resistance; actual oil resistance will vary depending on the product.
 The Pre-wired Connector Model has a verified oil resistance of 2 years when mated with XS5 NEXT Series round oil-resistant connectors.

Enables easier and standardized designs previously not possible



- The world's longest sensing distance*¹
Nearly double the sensing distance of previous
- With high-brightness LED, the indicator is visible anywhere from 360°.
- Only 10 Seconds*² to Replace a Proximity Sensor with the "e-jig" (Mounting Sleeve).
- Cables with enhanced oil resistance enabled 2-year oil resistance*³.
- IP69K compliant for water resistance and wash resistance*⁴
- Comes in a wide variation to make sensor selection easy
- UL certification (UL60947-5-2)*⁵ and CSA certification (CSA C22.2 UL60947-5-2-14)



For the most recent information on models that have been certified for safety standards, refer to your OMRON website.

*1. Based on December 2018 OMRON investigation.
 *2. Time required to adjust the distance when installing a Sensor. Based on OMRON investigation.
 *3. Refer to *Ratings and Specifications* for details. However, E2E Connector Models and E2EQ series is excluded.
 *4. E2EQ series is excluded.
 *5. M8 (4-pin) Connector Models are not UL certified.

Be sure to read *Safety Precautions* on page 61.

Features

PREMIUM Model

Easy design Standardized design

Exceptional sensing range*⁶

9 [M12] mm*⁷

The PREMIUM Model, which has a longer detection range compared to previous models, allows for more spacious designs with less risk of contact. It also enables you to standardize your designs by letting you adopt a single one-size model instead of multiple models of different sizes.

*6. Based on December 2018 OMRON investigation.
 *7. Quadruple distance models of M12 sized

Quadruple distance model
9mm [M12]

Triple distance model
6mm [M12]

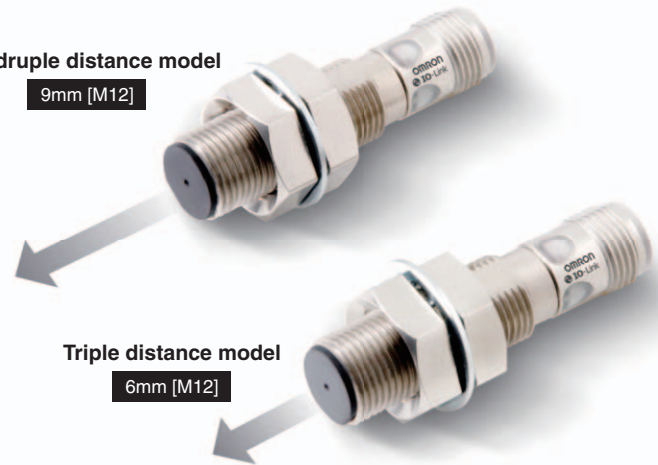

BASIC Model

In addition to our HIGH SPEC Models, we also offer mid/short-distance BASIC Models, to meet various facility design requirement specifications.

Double distance model

4mm [M12]

Single distance model

2mm [M12]



New standards for usability

Early error detection

1 location, all new E2E Sensors can be monitored with IO-Link IO-Link

Less unexpected facility stoppages

Strong resistance to cutting oil **2**-year oil resistance*⁹

Quick recovery

10 second replaceable with e-jig (adaptor)*⁸
360° degree view with high visibility LED indicator

*8. Time required to adjust the distance when installing a Sensor. Based on OMRON investigation.

*9. E2E Connector Models and E2EQ series is excluded.

E2E/E2EQ NEXT Series

E2E/E2EQ NEXT Series Model Number Legend

DC 3-wire

E2E (1) - X (2) (3) (4) (5) (6) (7) - (8) - (9) - (10) (11)

No.	Type	Code	Meaning
(1)	Case	Blank	Without spatter-resistant coating
		Q	With spatter-resistant coating
(2)	Sensing distance	Number	Sensing distance (Unit: mm) (R: Indication of decimal point)
(3)	Shielding	Blank	Shielded
		M	Unshielded
(4)	Output configuration	B	PNP open collector
		C	NPN open collector
(5)	Operation mode	1	Normally open (NO)
		2	Normally closed (NC)
		3	Normally open, Normally closed (NO+NC)
(6)	IO-Link baud rate	Blank	Non IO-Link compliant
		D	COM2 (38.4 kbps)
		T	COM3 (230.4 kbps)
(7)	Body size	Blank	Standard
		L	Long Body
(8)	Size	8	M8
		12	M12
		18	M18
		30	M30
(9)	Connection method	Blank	Pre-wired Models
		M1	M12 Connector Models
		M3	M8 (4-pin) Connector Models
		M5	M8 (3-pin) Connector Models
		M1TJ	M12 Pre-wired Smartclick Connector Models
		M1TJR	M12 Pre-wired Smartclick Connector Models Robot (bending-resistant) cable
(10)	Cable specifications *	Blank	Standard PVC cable
		R	Robot (bending-resistant) cable
(11)	Cable length	Number M	Cable length

* (10) is only shown in the model number of Pre-wired Models.

Note: The purpose of this model number legend is to provide understanding of the meaning of specifications from the model number. Models are not available for all combinations of code numbers.

Ordering Information

PREMIUM Model

E2E NEXT Series (Quadruple distance model)

DC 3-wire [Refer to Dimensions on page 64.]

Shielded *1

Size (Sensing distance)	Connection method	Body size	Operation mode	Model			
				PNP		NPN	
				IO-Link (COM3)	IO-Link (COM2) *5	--- *5	
M8 (4 mm)	Pre-wired (2 m) *2	38 mm *3	NO	E2E-X4B1T8 2M	E2E-X4B1D8 2M	E2E-X4C18 2M	
			NC	-	E2E-X4B28 2M	E2E-X4C28 2M	
		48 mm	NO	E2E-X4B1TL8 2M	E2E-X4B1DL8 2M	E2E-X4C1L8 2M	
			NC	-	E2E-X4B2L8 2M	E2E-X4C2L8 2M	
	M12 Pre-wired Smartclick Connector (0.3 m)	38 mm *4	NO	E2E-X4B1T8-M1TJ 0.3M	E2E-X4B1D8-M1TJ 0.3M	E2E-X4C18-M1TJ 0.3M	
			NC	-	E2E-X4B28-M1TJ 0.3M	E2E-X4C28-M1TJ 0.3M	
		48 mm	NO	E2E-X4B1TL8-M1TJ 0.3M	E2E-X4B1DL8-M1TJ 0.3M	E2E-X4C1L8-M1TJ 0.3M	
			NC	-	E2E-X4B2L8-M1TJ 0.3M	E2E-X4C2L8-M1TJ 0.3M	
	M12 Connector	43 mm	NO	E2E-X4B1T8-M1	E2E-X4B1D8-M1	E2E-X4C18-M1	
			NC	-	E2E-X4B28-M1	E2E-X4C28-M1	
		53 mm	NO	E2E-X4B1TL8-M1	E2E-X4B1DL8-M1	E2E-X4C1L8-M1	
			NC	-	E2E-X4B2L8-M1	E2E-X4C2L8-M1	
	M8 Connector (4-pin)	39 mm	NO	E2E-X4B1T8-M3	E2E-X4B1D8-M3	E2E-X4C18-M3	
			NC	-	E2E-X4B28-M3	E2E-X4C28-M3	
		49 mm	NO	E2E-X4B1TL8-M3	E2E-X4B1DL8-M3	E2E-X4C1L8-M3	
			NC	-	E2E-X4B2L8-M3	E2E-X4C2L8-M3	
	M8 Connector (3-pin)	39 mm	NO	E2E-X4B1T8-M5	E2E-X4B1D8-M5	E2E-X4C18-M5	
			NC	-	E2E-X4B28-M5	E2E-X4C28-M5	
		49 mm	NO	E2E-X4B1TL8-M5	E2E-X4B1DL8-M5	E2E-X4C1L8-M5	
			NC	-	E2E-X4B2L8-M5	E2E-X4C2L8-M5	
	M12 (9 mm)	Pre-wired (2 m) *2	47 mm *3	NO	E2E-X9B1T12 2M	E2E-X9B1D12 2M	E2E-X9C112 2M
				NC	-	E2E-X9B212 2M	E2E-X9C212 2M
			69 mm	NO	E2E-X9B1TL12 2M	E2E-X9B1DL12 2M	E2E-X9C1L12 2M
				NC	-	E2E-X9B2L12 2M	E2E-X9C2L12 2M
M12 Pre-wired Smartclick Connector (0.3 m)		47 mm *4	NO	E2E-X9B1T12-M1TJ 0.3M	E2E-X9B1D12-M1TJ 0.3M	E2E-X9C112-M1TJ 0.3M	
			NC	-	E2E-X9B212-M1TJ 0.3M	E2E-X9C212-M1TJ 0.3M	
		69 mm	NO	E2E-X9B1TL12-M1TJ 0.3M	E2E-X9B1DL12-M1TJ 0.3M	E2E-X9C1L12-M1TJ 0.3M	
			NC	-	E2E-X9B2L12-M1TJ 0.3M	E2E-X9C2L12-M1TJ 0.3M	
M12 Connector		48 mm	NO	E2E-X9B1T12-M1	E2E-X9B1D12-M1	E2E-X9C112-M1	
			NC	-	E2E-X9B212-M1	E2E-X9C212-M1	
		70 mm	NO	E2E-X9B1TL12-M1	E2E-X9B1DL12-M1	E2E-X9C1L12-M1	
			NC	-	E2E-X9B2L12-M1	E2E-X9C2L12-M1	
M18 (14 mm)		Pre-wired (2 m) *2	55 mm *3	NO	E2E-X14B1T18 2M	E2E-X14B1D18 2M	E2E-X14C118 2M
				NC	-	E2E-X14B218 2M	E2E-X14C218 2M
			77 mm	NO	E2E-X14B1TL18 2M	E2E-X14B1DL18 2M	E2E-X14C1L18 2M
				NC	-	E2E-X14B2L18 2M	E2E-X14C2L18 2M
	M12 Pre-wired Smartclick Connector (0.3 m)	55 mm *4	NO	E2E-X14B1T18-M1TJ 0.3M	E2E-X14B1D18-M1TJ 0.3M	E2E-X14C118-M1TJ 0.3M	
			NC	-	E2E-X14B218-M1TJ 0.3M	E2E-X14C218-M1TJ 0.3M	
		77 mm	NO	E2E-X14B1TL18-M1TJ 0.3M	E2E-X14B1DL18-M1TJ 0.3M	E2E-X14C1L18-M1TJ 0.3M	
			NC	-	E2E-X14B2L18-M1TJ 0.3M	E2E-X14C2L18-M1TJ 0.3M	
	M12 Connector	53 mm	NO	E2E-X14B1T18-M1	E2E-X14B1D18-M1	E2E-X14C118-M1	
			NC	-	E2E-X14B218-M1	E2E-X14C218-M1	
		75 mm	NO	E2E-X14B1TL18-M1	E2E-X14B1DL18-M1	E2E-X14C1L18-M1	
			NC	-	E2E-X14B2L18-M1	E2E-X14C2L18-M1	

E2E/E2EQ NEXT Series DC 3-wire

E2E/E2EQ NEXT Series DC 2-wire

XSS5 NEXT Series

XSS5

XSS3

E2E/E2EQ NEXT Series

PREMIUM Model

Size (Sensing distance)	Connection method	Body size	Operation mode	Model		
				PNP		NPN
				IO-Link (COM3)	IO-Link (COM2) *5	--- *5
M30 (23 mm)	Pre-wired (2 m) *2	60 mm *4	NO	E2E-X23B1T30 2M	E2E-X23B1D30 2M	E2E-X23C130 2M
			NC	-	E2E-X23B230 2M	E2E-X23C230 2M
		82 mm	NO	E2E-X23B1TL30 2M	E2E-X23B1DL30 2M	E2E-X23C1L30 2M
			NC	-	E2E-X23B2L30 2M	E2E-X23C2L30 2M
	M12 Pre-wired Smartclick Connector (0.3 m)	60 mm *4	NO	E2E-X23B1T30-M1TJ 0.3M	E2E-X23B1D30-M1TJ 0.3M	E2E-X23C130-M1TJ 0.3M
			NC	-	E2E-X23B230-M1TJ 0.3M	E2E-X23C230-M1TJ 0.3M
		82 mm	NO	E2E-X23B1TL30-M1TJ 0.3M	E2E-X23B1DL30-M1TJ 0.3M	E2E-X23C1L30-M1TJ 0.3M
			NC	-	E2E-X23B2L30-M1TJ 0.3M	E2E-X23C2L30-M1TJ 0.3M
	M12 Connector	58 mm	NO	E2E-X23B1T30-M1	E2E-X23B1D30-M1	E2E-X23C130-M1
			NC	-	E2E-X23B230-M1	E2E-X23C230-M1
		80 mm	NO	E2E-X23B1TL30-M1	E2E-X23B1DL30-M1	E2E-X23C1L30-M1
			NC	-	E2E-X23B2L30-M1	E2E-X23C2L30-M1

*1. When embedding the Proximity Sensor in metal, refer to *Influence of Surrounding Metal* on page 62.

*2. Models with 5-m cable length are also available with "5M" suffix. (Example: E2E-X9B1D12 5M)

*3. Models with 2-m and 5-m robot (bending-resistant) cables are also available with "-R" in the model number. (Example: E2E-X9B1D12-R 2M/ E2E-X9B1D12-R 5M)

*4. Models with M12 Smartclick connector model robot (bending-resistant) cables are also available with "R" in the model number. (Example: E2E-X9B1D12-M1TJR 0.3M)

*5. IO-Link is not supported for NC-type PNP outputs or all types of NPN outputs.

Note: Operation mode NO can be changed to NC via IO-Link communications.

PREMIUM Model

E2E NEXT Series (Quadruple distance model)

DC 3-wire [Refer to Dimensions on page 64.]

Unshielded

Size (Sensing distance)	Connection method	Body size	Operation mode	Model			
				PNP		NPN	
				IO-Link (COM3)	IO-Link (COM2) *4	--- *4	
M8 (8 mm)	Pre-wired (2 m) *1	38 mm *2	NO	E2E-X8MB1T8 2M	E2E-X8MB1D8 2M	E2E-X8MC18 2M	
			NC	-	E2E-X8MB28 2M	E2E-X8MC28 2M	
		48 mm	NO	E2E-X8MB1TL8 2M	E2E-X8MB1DL8 2M	E2E-X8MC1L8 2M	
			NC	-	E2E-X8MB2L8 2M	E2E-X8MC2L8 2M	
	M12 Pre-wired Smartclick Connector (0.3 m)	38 mm *3	NO	E2E-X8MB1T8-M1TJ 0.3M	E2E-X8MB1D8-M1TJ 0.3M	E2E-X8MC18-M1TJ 0.3M	
			NC	-	E2E-X8MB28-M1TJ 0.3M	E2E-X8MC28-M1TJ 0.3M	
		48 mm	NO	E2E-X8MB1TL8-M1TJ 0.3M	E2E-X8MB1DL8-M1TJ 0.3M	E2E-X8MC1L8-M1TJ 0.3M	
			NC	-	E2E-X8MB2L8-M1TJ 0.3M	E2E-X8MC2L8-M1TJ 0.3M	
	M12 Connector	43 mm	NO	E2E-X8MB1T8-M1	E2E-X8MB1D8-M1	E2E-X8MC18-M1	
			NC	-	E2E-X8MB28-M1	E2E-X8MC28-M1	
		53 mm	NO	E2E-X8MB1TL8-M1	E2E-X8MB1DL8-M1	E2E-X8MC1L8-M1	
			NC	-	E2E-X8MB2L8-M1	E2E-X8MC2L8-M1	
	M8 Connector (4-pin)	39 mm	NO	E2E-X8MB1T8-M3	E2E-X8MB1D8-M3	E2E-X8MC18-M3	
			NC	-	E2E-X8MB28-M3	E2E-X8MC28-M3	
		49 mm	NO	E2E-X8MB1TL8-M3	E2E-X8MB1DL8-M3	E2E-X8MC1L8-M3	
			NC	-	E2E-X8MB2L8-M3	E2E-X8MC2L8-M3	
	M8 Connector (3-pin)	39 mm	NO	E2E-X8MB1T8-M5	E2E-X8MB1D8-M5	E2E-X8MC18-M5	
			NC	-	E2E-X8MB28-M5	E2E-X8MC28-M5	
		49 mm	NO	E2E-X8MB1TL8-M5	E2E-X8MB1DL8-M5	E2E-X8MC1L8-M5	
			NC	-	E2E-X8MB2L8-M5	E2E-X8MC2L8-M5	
	M12 (16 mm)	Pre-wired (2 m) *1	47 mm *2	NO	E2E-X16MB1T12 2M	E2E-X16MB1D12 2M	E2E-X16MC112 2M
				NC	-	E2E-X16MB212 2M	E2E-X16MC212 2M
			69 mm	NO	E2E-X16MB1TL12 2M	E2E-X16MB1DL12 2M	E2E-X16MC1L12 2M
				NC	-	E2E-X16MB2L12 2M	E2E-X16MC2L12 2M
M12 Pre-wired Smartclick Connector (0.3 m)		47 mm *3	NO	E2E-X16MB1T12-M1TJ 0.3M	E2E-X16MB1D12-M1TJ 0.3M	E2E-X16MC112-M1TJ 0.3M	
			NC	-	E2E-X16MB212-M1TJ 0.3M	E2E-X16MC212-M1TJ 0.3M	
		69 mm	NO	E2E-X16MB1TL12-M1TJ 0.3M	E2E-X16MB1DL12-M1TJ 0.3M	E2E-X16MC1L12-M1TJ 0.3M	
			NC	-	E2E-X16MB2L12-M1TJ 0.3M	E2E-X16MC2L12-M1TJ 0.3M	
M12 Connector		48 mm	NO	E2E-X16MB1T12-M1	E2E-X16MB1D12-M1	E2E-X16MC112-M1	
			NC	-	E2E-X16MB212-M1	E2E-X16MC212-M1	
		70 mm	NO	E2E-X16MB1TL12-M1	E2E-X16MB1DL12-M1	E2E-X16MC1L12-M1	
			NC	-	E2E-X16MB2L12-M1	E2E-X16MC2L12-M1	
M18 (30 mm)	Pre-wired (2 m) *1	77 mm *2	NO	E2E-X30MB1TL18 2M	E2E-X30MB1DL18 2M	E2E-X30MC1L18 2M	
			NC	-	E2E-X30MB2L18 2M	E2E-X30MC2L18 2M	
	M12 Pre-wired Smartclick Connector (0.3 m)	77 mm *3	NO	E2E-X30MB1TL18-M1TJ 0.3M	E2E-X30MB1DL18-M1TJ 0.3M	E2E-X30MC1L18-M1TJ 0.3M	
			NC	-	E2E-X30MB2L18-M1TJ 0.3M	E2E-X30MC2L18-M1TJ 0.3M	
	M12 Connector	75 mm	NO	E2E-X30MB1TL18-M1	E2E-X30MB1DL18-M1	E2E-X30MC1L18-M1	
			NC	-	E2E-X30MB2L18-M1	E2E-X30MC2L18-M1	
M30 (50 mm)	Pre-wired (2 m) *1	97 mm *2	NO	E2E-X50MB1TL30 2M	E2E-X50MB1DL30 2M	E2E-X50MC1L30 2M	
			NC	-	E2E-X50MB2L30 2M	E2E-X50MC2L30 2M	
	M12 Pre-wired Smartclick Connector (0.3 m)	97 mm *3	NO	E2E-X50MB1TL30-M1TJ 0.3M	E2E-X50MB1DL30-M1TJ 0.3M	E2E-X50MC1L30-M1TJ 0.3M	
			NC	-	E2E-X50MB2L30-M1TJ 0.3M	E2E-X50MC2L30-M1TJ 0.3M	
	M12 Connector	95 mm	NO	E2E-X50MB1TL30-M1	E2E-X50MB1DL30-M1	E2E-X50MC1L30-M1	
			NC	-	E2E-X50MB2L30-M1	E2E-X50MC2L30-M1	

*1. Models with 5-m cable length are also available (Example: E2E-X16MB1D12 5M)

*2. Models with 2-m and 5-m robot (bending-resistant) cables are also available with "-R" in the model number. (Example: E2E-X16MB1D12-R 2M/E2E-X16MB1D12-R 5M)

*3. Models with M12 Smartclick connector model robot (bending-resistant) cables are also available with "R" in the model number. (Example: E2E-X16MB1D12-M1TJR 0.3M)

*4. IO-Link is not supported for NC-type PNP outputs or all types of NPN outputs.

Note: Operation mode NO can be changed to NC via IO-Link communications.

E2E/E2EQ NEXT Series

PREMIUM Model

E2E NEXT Series (Triple distance model)

DC 3-wire [Refer to *Dimensions* on page 64.]

Shielded *1

Size (Sensing distance)	Connection method	Body size	Operation mode	Model			
				PNP		NPN	
				IO-Link (COM3)	IO-Link (COM2) *5	--- *5	
M8 (3 mm)	Pre-wired (2 m) *2	38 mm *3	NO	E2E-X3B1T8 2M	E2E-X3B1D8 2M	E2E-X3C18 2M	
			NC	-	E2E-X3B28 2M	E2E-X3C28 2M	
		48 mm	NO	E2E-X3B1TL8 2M	E2E-X3B1DL8 2M	E2E-X3C1L8 2M	
			NC	-	E2E-X3B2L8 2M	E2E-X3C2L8 2M	
	M12 Pre-wired Smartclick Connector (0.3 m)	38 mm *4	NO	E2E-X3B1T8-M1TJ 0.3M	E2E-X3B1D8-M1TJ 0.3M	E2E-X3C18-M1TJ 0.3M	
			NC	-	E2E-X3B28-M1TJ 0.3M	E2E-X3C28-M1TJ 0.3M	
		48 mm	NO	E2E-X3B1TL8-M1TJ 0.3M	E2E-X3B1DL8-M1TJ 0.3M	E2E-X3C1L8-M1TJ 0.3M	
			NC	-	E2E-X3B2L8-M1TJ 0.3M	E2E-X3C2L8-M1TJ 0.3M	
	M12 Connector	43 mm	NO	E2E-X3B1T8-M1	E2E-X3B1D8-M1	E2E-X3C18-M1	
			NC	-	E2E-X3B28-M1	E2E-X3C28-M1	
		53 mm	NO	E2E-X3B1TL8-M1	E2E-X3B1DL8-M1	E2E-X3C1L8-M1	
			NC	-	E2E-X3B2L8-M1	E2E-X3C2L8-M1	
	M8 Connector (4-pin)	39 mm	NO	E2E-X3B1T8-M3	E2E-X3B1D8-M3	E2E-X3C18-M3	
			NC	-	E2E-X3B28-M3	E2E-X3C28-M3	
		49 mm	NO	E2E-X3B1TL8-M3	E2E-X3B1DL8-M3	E2E-X3C1L8-M3	
			NC	-	E2E-X3B2L8-M3	E2E-X3C2L8-M3	
	M8 Connector (3-pin)	39 mm	NO	E2E-X3B1T8-M5	E2E-X3B1D8-M5	E2E-X3C18-M5	
			NC	-	E2E-X3B28-M5	E2E-X3C28-M5	
		49 mm	NO	E2E-X3B1TL8-M5	E2E-X3B1DL8-M5	E2E-X3C1L8-M5	
			NC	-	E2E-X3B2L8-M5	E2E-X3C2L8-M5	
	M12 (6 mm)	Pre-wired (2 m) *2	47 mm *3	NO	E2E-X6B1T12 2M	E2E-X6B1D12 2M	E2E-X6C112 2M
				NC	-	E2E-X6B212 2M	E2E-X6C212 2M
				NO+NC	-	E2E-X6B3D12 2M	E2E-X6C312 2M
			69 mm	NO	E2E-X6B1TL12 2M	E2E-X6B1DL12 2M	E2E-X6C1L12 2M
NC				-	E2E-X6B2L12 2M	E2E-X6C2L12 2M	
NO+NC				-	E2E-X6B3DL12 2M	E2E-X6C3L12 2M	
M12 Pre-wired Smartclick Connector (0.3 m)		47 mm *4	NO	E2E-X6B1T12-M1TJ 0.3M	E2E-X6B1D12-M1TJ 0.3M	E2E-X6C112-M1TJ 0.3M	
			NC	-	E2E-X6B212-M1TJ 0.3M	E2E-X6C212-M1TJ 0.3M	
			NO+NC	-	E2E-X6B3D12-M1TJ 0.3M	E2E-X6C312-M1TJ 0.3M	
		69 mm	NO	E2E-X6B1TL12-M1TJ 0.3M	E2E-X6B1DL12-M1TJ 0.3M	E2E-X6C1L12-M1TJ 0.3M	
			NC	-	E2E-X6B2L12-M1TJ 0.3M	E2E-X6C2L12-M1TJ 0.3M	
			NO+NC	-	E2E-X6B3DL12-M1TJ 0.3M	E2E-X6C3L12-M1TJ 0.3M	
M12 Connector		48 mm	NO	E2E-X6B1T12-M1	E2E-X6B1D12-M1	E2E-X6C112-M1	
			NC	-	E2E-X6B212-M1	E2E-X6C212-M1	
			NO+NC	-	E2E-X6B3D12-M1	E2E-X6C312-M1	
		70 mm	NO	E2E-X6B1TL12-M1	E2E-X6B1DL12-M1	E2E-X6C1L12-M1	
			NC	-	E2E-X6B2L12-M1	E2E-X6C2L12-M1	
			NO+NC	-	E2E-X6B3DL12-M1	E2E-X6C3L12-M1	

PREMIUM Model						
Size (Sensing distance)	Connection method	Body size	Operation mode	Model		
				PNP		NPN
				IO-Link (COM3)	IO-Link (COM2) *5	--- *5
M18 (12 mm)	Pre-wired (2 m) *2	55 mm *3	NO	E2E-X12B1T18 2M	E2E-X12B1D18 2M	E2E-X12C118 2M
			NC	-	E2E-X12B218 2M	E2E-X12C218 2M
			NO+NC	-	E2E-X12B3D18 2M	E2E-X12C318 2M
		77 mm	NO	E2E-X12B1TL18 2M	E2E-X12B1DL18 2M	E2E-X12C1L18 2M
			NC	-	E2E-X12B2L18 2M	E2E-X12C2L18 2M
			NO+NC	-	E2E-X12B3DL18 2M	E2E-X12C3L18 2M
	M12 Pre-wired Smartclick Connector (0.3 m)	55 mm *4	NO	E2E-X12B1T18-M1TJ 0.3M	E2E-X12B1D18-M1TJ 0.3M	E2E-X12C118-M1TJ 0.3M
			NC	-	E2E-X12B218-M1TJ 0.3M	E2E-X12C218-M1TJ 0.3M
			NO+NC	-	E2E-X12B3D18-M1TJ 0.3M	E2E-X12C318-M1TJ 0.3M
		77 mm	NO	E2E-X12B1TL18-M1TJ 0.3M	E2E-X12B1DL18-M1TJ 0.3M	E2E-X12C1L18-M1TJ 0.3M
			NC	-	E2E-X12B2L18-M1TJ 0.3M	E2E-X12C2L18-M1TJ 0.3M
			NO+NC	-	E2E-X12B3DL18-M1TJ 0.3M	E2E-X12C3L18-M1TJ 0.3M
	M12 Connector	53 mm	NO	E2E-X12B1T18-M1	E2E-X12B1D18-M1	E2E-X12C118-M1
			NC	-	E2E-X12B218-M1	E2E-X12C218-M1
			NO+NC	-	E2E-X12B3D18-M1	E2E-X12C318-M1
		75 mm	NO	E2E-X12B1TL18-M1	E2E-X12B1DL18-M1	E2E-X12C1L18-M1
			NC	-	E2E-X12B2L18-M1	E2E-X12C2L18-M1
			NO+NC	-	E2E-X12B3DL18-M1	E2E-X12C3L18-M1
M30 (22 mm)	Pre-wired (2 m) *2	60 mm *3	NO	E2E-X22B1T30 2M	E2E-X22B1D30 2M	E2E-X22C130 2M
			NC	-	E2E-X22B230 2M	E2E-X22C230 2M
			NO+NC	-	E2E-X22B3D30 2M	E2E-X22C330 2M
		82 mm	NO	E2E-X22B1TL30 2M	E2E-X22B1DL30 2M	E2E-X22C1L30 2M
			NC	-	E2E-X22B2L30 2M	E2E-X22C2L30 2M
			NO+NC	-	E2E-X22B3DL30 2M	E2E-X22C3L30 2M
	M12 Pre-wired Smartclick Connector (0.3 m)	60 mm *4	NO	E2E-X22B1T30-M1TJ 0.3M	E2E-X22B1D30-M1TJ 0.3M	E2E-X22C130-M1TJ 0.3M
			NC	-	E2E-X22B230-M1TJ 0.3M	E2E-X22C230-M1TJ 0.3M
			NO+NC	-	E2E-X22B3D30-M1TJ 0.3M	E2E-X22C330-M1TJ 0.3M
		82 mm	NO	E2E-X22B1TL30-M1TJ 0.3M	E2E-X22B1DL30-M1TJ 0.3M	E2E-X22C1L30-M1TJ 0.3M
			NC	-	E2E-X22B2L30-M1TJ 0.3M	E2E-X22C2L30-M1TJ 0.3M
			NO+NC	-	E2E-X22B3DL30-M1TJ 0.3M	E2E-X22C3L30-M1TJ 0.3M
	M12 Connector	58 mm	NO	E2E-X22B1T30-M1	E2E-X22B1D30-M1	E2E-X22C130-M1
			NC	-	E2E-X22B230-M1	E2E-X22C230-M1
			NO+NC	-	E2E-X22B3D30-M1	E2E-X22C330-M1
		80 mm	NO	E2E-X22B1TL30-M1	E2E-X22B1DL30-M1	E2E-X22C1L30-M1
			NC	-	E2E-X22B2L30-M1	E2E-X22C2L30-M1
			NO+NC	-	E2E-X22B3DL30-M1	E2E-X22C3L30-M1

*1. When embedding the Proximity Sensor in metal, refer to *Influence of Surrounding Metal* on page 62.

*2. Models with 5-m cable length are also available (Example: E2E-X6B1D12 5M)

*3. Models with 2-m and 5-m robot (bending-resistant) cables are also available with "-R" in the model number. (Example: E2E-X6B1D12-R 2M/ E2E-X6B1D12-R 5M)

*4. Models with M12 Smartclick connector model robot (bending-resistant) cables are also available with "R" in the model number. (Example: E2E-X6B1D12-M1TJR 0.3M)

*5. IO-Link is not supported for NC-type PNP outputs or all types of NPN outputs.

Note: Operation mode NO can be changed to NC via IO-Link communications.

E2E/E2EQ NEXT Series

PREMIUM Model

E2E NEXT Series (Triple distance model)

DC 3-wire [Refer to Dimensions on page 64.]

Unshielded

Size (Sensing distance)	Connection method	Body size	Operation mode	Model			
				PNP		NPN	
				IO-Link (COM3)	IO-Link (COM2) *4	--- *4	
M8 (6 mm)	Pre-wired (2 m) *1	38 mm *2	NO	E2E-X6MB1T8 2M	E2E-X6MB1D8 2M	E2E-X6MC18 2M	
			NC	-	E2E-X6MB28 2M	E2E-X6MC28 2M	
		48 mm	NO	E2E-X6MB1TL8 2M	E2E-X6MB1DL8 2M	E2E-X6MC1L8 2M	
			NC	-	E2E-X6MB2L8 2M	E2E-X6MC2L8 2M	
	M12 Pre-wired Smartclick Connector (0.3 m)	38 mm *3	NO	E2E-X6MB1T8-M1TJ 0.3M	E2E-X6MB1D8-M1TJ 0.3M	E2E-X6MC18-M1TJ 0.3M	
			NC	-	E2E-X6MB28-M1TJ 0.3M	E2E-X6MC28-M1TJ 0.3M	
		48 mm	NO	E2E-X6MB1TL8-M1TJ 0.3M	E2E-X6MB1DL8-M1TJ 0.3M	E2E-X6MC1L8-M1TJ 0.3M	
			NC	-	E2E-X6MB2L8-M1TJ 0.3M	E2E-X6MC2L8-M1TJ 0.3M	
	M12 Connector	43 mm	NO	E2E-X6MB1T8-M1	E2E-X6MB1D8-M1	E2E-X6MC18-M1	
			NC	-	E2E-X6MB28-M1	E2E-X6MC28-M1	
		53 mm	NO	E2E-X6MB1TL8-M1	E2E-X6MB1DL8-M1	E2E-X6MC1L8-M1	
			NC	-	E2E-X6MB2L8-M1	E2E-X6MC2L8-M1	
	M8 Connector (4-pin)	39 mm	NO	E2E-X6MB1T8-M3	E2E-X6MB1D8-M3	E2E-X6MC18-M3	
			NC	-	E2E-X6MB28-M3	E2E-X6MC28-M3	
		49 mm	NO	E2E-X6MB1TL8-M3	E2E-X6MB1DL8-M3	E2E-X6MC1L8-M3	
			NC	-	E2E-X6MB2L8-M3	E2E-X6MC2L8-M3	
	M8 Connector (3-pin)	39 mm	NO	E2E-X6MB1T8-M5	E2E-X6MB1D8-M5	E2E-X6MC18-M5	
			NC	-	E2E-X6MB28-M5	E2E-X6MC28-M5	
		49 mm	NO	E2E-X6MB1TL8-M5	E2E-X6MB1DL8-M5	E2E-X6MC1L8-M5	
			NC	-	E2E-X6MB2L8-M5	E2E-X6MC2L8-M5	
	M12 (10 mm)	Pre-wired (2 m) *1	47 mm *2	NO	E2E-X10MB1T12 2M	E2E-X10MB1D12 2M	E2E-X10MC112 2M
				NC	-	E2E-X10MB212 2M	E2E-X10MC212 2M
				NO+NC	-	E2E-X10MB3D12 2M	E2E-X10MC312 2M
			69 mm	NO	E2E-X10MB1TL12 2M	E2E-X10MB1DL12 2M	E2E-X10MC1L12 2M
NC				-	E2E-X10MB2L12 2M	E2E-X10MC2L12 2M	
NO+NC				-	E2E-X10MB3DL12 2M	E2E-X10MC3L12 2M	
M12 Pre-wired Smartclick Connector (0.3 m)		47 mm *3	NO	E2E-X10MB1T12-M1TJ 0.3M	E2E-X10MB1D12-M1TJ 0.3M	E2E-X10MC112-M1TJ 0.3M	
			NC	-	E2E-X10MB212-M1TJ 0.3M	E2E-X10MC212-M1TJ 0.3M	
			NO+NC	-	E2E-X10MB3D12-M1TJ 0.3M	E2E-X10MC312-M1TJ 0.3M	
		69 mm	NO	E2E-X10MB1TL12-M1TJ 0.3M	E2E-X10MB1DL12-M1TJ 0.3M	E2E-X10MC1L12-M1TJ 0.3M	
			NC	-	E2E-X10MB2L12-M1TJ 0.3M	E2E-X10MC2L12-M1TJ 0.3M	
			NO+NC	-	E2E-X10MB3DL12-M1TJ 0.3M	E2E-X10MC3L12-M1TJ 0.3M	
M12 Connector		48 mm	NO	E2E-X10MB1T12-M1	E2E-X10MB1D12-M1	E2E-X10MC112-M1	
			NC	-	E2E-X10MB212-M1	E2E-X10MC212-M1	
			NO+NC	-	E2E-X10MB3D12-M1	E2E-X10MC312-M1	
		70 mm	NO	E2E-X10MB1TL12-M1	E2E-X10MB1DL12-M1	E2E-X10MC1L12-M1	
			NC	-	E2E-X10MB2L12-M1	E2E-X10MC2L12-M1	
			NO+NC	-	E2E-X10MB3DL12-M1	E2E-X10MC3L12-M1	
M18 (20 mm)		Pre-wired (2 m) *1	77 mm *2	NO	E2E-X20MB1TL18 2M	E2E-X20MB1DL18 2M	E2E-X20MC1L18 2M
				NC	-	E2E-X20MB2L18 2M	E2E-X20MC2L18 2M
				NO+NC	-	E2E-X20MB3DL18 2M	E2E-X20MC3L18 2M
		M12 Pre-wired Smartclick Connector (0.3 m)	77 mm *3	NO	E2E-X20MB1TL18-M1TJ	E2E-X20MB1DL18-M1TJ	E2E-X20MC1L18-M1TJ 0.3M
				NC	-	E2E-X20MB2L18-M1TJ 0.3M	E2E-X20MC2L18-M1TJ 0.3M
				NO+NC	-	E2E-X20MB3DL18-M1TJ 0.3M	E2E-X20MC3L18-M1TJ 0.3M
	M12 Connector	75 mm	NO	E2E-X20MB1TL18-M1	E2E-X20MB1DL18-M1	E2E-X20MC1L18-M1	
			NC	-	E2E-X20MB2L18-M1	E2E-X20MC2L18-M1	
			NO+NC	-	E2E-X20MB3DL18-M1	E2E-X20MC3L18-M1	

PREMIUM Model

Size (Sensing distance)	Connection method	Body size	Operation mode	Model		
				PNP		NPN
				IO-Link (COM3)	IO-Link (COM2) *4	--- *4
M30 (40 mm)	Pre-wired (2 m) *1	82 mm *2	NO	E2E-X40MB1TL30 2M	E2E-X40MB1DL30 2M	E2E-X40MC1L30 2M
			NC	-	E2E-X40MB2L30 2M	E2E-X40MC2L30 2M
			NO+NC	-	E2E-X40MB3DL30 2M	E2E-X40MC3L30 2M
	M12 Pre-wired Smartclick Connector (0.3 m)	82 mm *3	NO	E2E-X40MB1TL30-M1TJ 0.3M	E2E-X40MB1DL30-M1TJ 0.3M	E2E-X40MC1L30-M1TJ 0.3M
			NC	-	E2E-X40MB2L30-M1TJ 0.3M	E2E-X40MC2L30-M1TJ 0.3M
			NO+NC	-	E2E-X40MB3DL30-M1TJ 0.3M	E2E-X40MC3L30-M1TJ 0.3M
	M12 Connector	80 mm	NO	E2E-X40MB1TL30-M1	E2E-X40MB1DL30-M1	E2E-X40MC1L30-M1
			NC	-	E2E-X40MB2L30-M1	E2E-X40MC2L30-M1
			NO+NC	-	E2E-X40MB3DL30-M1	E2E-X40MC3L30-M1

*1. Models with 5-m cable length are also available (Example: E2E-X10MB1D12 5M)

*2. Models with 2-m and 5-m robot (bending-resistant) cables are also available with "-R" in the model number. (Example: E2E-X10MB1D12-R 2M/E2E-X10MB1D12-R 5M)

*3. Models with M12 Smartclick connector model robot (bending-resistant) cables are also available with "R" in the model number. (Example: E2E-X10MB1D12-M1TJR 0.3M)

*4. IO-Link is not supported for NC-type PNP outputs or all types of NPN outputs.

Note: Operation mode NO can be changed to NC via IO-Link communications.

E2E/E2EQ NEXT Series

PREMIUM Model

E2EQ NEXT Series (Spatter-resistant Triple distance model)

DC 3-wire [Refer to *Dimensions* on page 64.]

Shielded *1

Size (Sensing distance)	Connection method	Body size	Operation mode	Model			
				PNP		NPN	
				IO-Link (COM3)	IO-Link (COM2) *3	--- *3	
M8 (3 mm)	Pre-wired (2 m) *2	38 mm	NO	E2EQ-X3B1T8 2M	E2EQ-X3B1D8 2M	E2EQ-X3C18 2M	
			NC	-	E2EQ-X3B28 2M	E2EQ-X3C28 2M	
	M12 Pre-wired Smartclick Connector (0.3 m)	38 mm	NO	E2EQ-X3B1T8-M1TJ 0.3M	E2EQ-X3B1D8-M1TJ 0.3M	E2EQ-X3C18-M1TJ 0.3M	
			NC	-	E2EQ-X3B28-M1TJ 0.3M	E2EQ-X3C28-M1TJ 0.3M	
	M12 Connector	43 mm	NO	E2EQ-X3B1T8-M1	E2EQ-X3B1D8-M1	E2EQ-X3C18-M1	
			NC	-	E2EQ-X3B28-M1	E2EQ-X3C28-M1	
M12 (6 mm)	Pre-wired (2 m) *2	47 mm	NO	E2EQ-X6B1T12 2M	E2EQ-X6B1D12 2M	E2EQ-X6C112 2M	
			NC	-	E2EQ-X6B212 2M	E2EQ-X6C212 2M	
			NO+NC	-	E2EQ-X6B3D12 2M	E2EQ-X6C312 2M	
	M12 Pre-wired Smartclick Connector (0.3 m)	47 mm	NO	E2EQ-X6B1T12-M1TJ 0.3M	E2EQ-X6B1D12-M1TJ 0.3M	E2EQ-X6C112-M1TJ 0.3M	
			NC	-	E2EQ-X6B212-M1TJ 0.3M	E2EQ-X6C212-M1TJ 0.3M	
			NO+NC	-	E2EQ-X6B3D12-M1TJ 0.3M	E2EQ-X6C312-M1TJ 0.3M	
	M12 Connector	48 mm	NO	E2EQ-X6B1T12-M1	E2EQ-X6B1D12-M1	E2EQ-X6C112-M1	
			NC	-	E2EQ-X6B212-M1	E2EQ-X6C212-M1	
			NO+NC	-	E2EQ-X6B3D12-M1	E2EQ-X6C312-M1	
	M18 (12 mm)	Pre-wired (2 m) *2	55 mm	NO	E2EQ-X12B1T18 2M	E2EQ-X12B1D18 2M	E2EQ-X12C118 2M
				NC	-	E2EQ-X12B218 2M	E2EQ-X12C218 2M
				NO+NC	-	E2EQ-X12B3D18 2M	E2EQ-X12C318 2M
M12 Pre-wired Smartclick Connector (0.3 m)		55 mm	NO	E2EQ-X12B1T18-M1TJ 0.3M	E2EQ-X12B1D18-M1TJ 0.3M	E2EQ-X12C118-M1TJ 0.3M	
			NC	-	E2EQ-X12B218-M1TJ 0.3M	E2EQ-X12C218-M1TJ 0.3M	
			NO+NC	-	E2EQ-X12B3D18-M1TJ 0.3M	E2EQ-X12C318-M1TJ 0.3M	
M12 Connector		53 mm	NO	E2EQ-X12B1T18-M1	E2EQ-X12B1D18-M1	E2EQ-X12C118-M1	
			NC	-	E2EQ-X12B218-M1	E2EQ-X12C218-M1	
			NO+NC	-	E2EQ-X12B3D18-M1	E2EQ-X12C318-M1	
M30 (22 mm)	Pre-wired (2 m) *2	60 mm	NO	E2EQ-X22B1T30 2M	E2EQ-X22B1D30 2M	E2EQ-X22C130 2M	
			NC	-	E2EQ-X22B230 2M	E2EQ-X22C230 2M	
			NO+NC	-	E2EQ-X22B3D30 2M	E2EQ-X22C330 2M	
	M12 Pre-wired Smartclick Connector (0.3 m)	60 mm	NO	E2EQ-X22B1T30-M1TJ 0.3M	E2EQ-X22B1D30-M1TJ 0.3M	E2EQ-X22C130-M1TJ 0.3M	
			NC	-	E2EQ-X22B230-M1TJ 0.3M	E2EQ-X22C230-M1TJ 0.3M	
			NO+NC	-	E2EQ-X22B3D30-M1TJ 0.3M	E2EQ-X22C330-M1TJ 0.3M	
	M12 Connector	58 mm	NO	E2EQ-X22B1T30-M1	E2EQ-X22B1D30-M1	E2EQ-X22C130-M1	
			NC	-	E2EQ-X22B230-M1	E2EQ-X22C230-M1	
			NO+NC	-	E2EQ-X22B3D30-M1	E2EQ-X22C330-M1	

*1. When embedding the Proximity Sensor in metal, refer to *Influence of Surrounding Metal* on page 62.

*2. Models with 5-m cable length are also available (Example: E2EQ-X6B1D12 5M)

*3. IO-Link is not supported for NC-type PNP outputs or all types of NPN outputs.

Note: Operation mode NO can be changed to NC via IO-Link communications.

BASIC Model

E2E NEXT Series (Double distance model)

DC 3-wire [Refer to Dimensions on page 65.]

Shielded

Size (Sensing distance)	Connection method	Body size	Operation mode	Model			
				PNP		NPN	
				IO-Link (COM3)	IO-Link (COM2) *4	--- *4	
M8 (2 mm)	Pre-wired (2 m) *1	38 mm *2	NO	E2E-X2B1T8 2M	E2E-X2B1D8 2M	E2E-X2C18 2M	
			NC	-	E2E-X2B28 2M	E2E-X2C28 2M	
		48 mm	NO	E2E-X2B1TL8 2M	E2E-X2B1DL8 2M	E2E-X2C1L8 2M	
			NC	-	E2E-X2B2L8 2M	E2E-X2C2L8 2M	
	M12 Pre-wired Smartclick Connector (0.3 m)	38 mm *3	NO	E2E-X2B1T8-M1TJ 0.3M	E2E-X2B1D8-M1TJ 0.3M	E2E-X2C18-M1TJ 0.3M	
			NC	-	E2E-X2B28-M1TJ 0.3M	E2E-X2C28-M1TJ 0.3M	
		48 mm	NO	E2E-X2B1TL8-M1TJ 0.3M	E2E-X2B1DL8-M1TJ 0.3M	E2E-X2C1L8-M1TJ 0.3M	
			NC	-	E2E-X2B2L8-M1TJ 0.3M	E2E-X2C2L8-M1TJ 0.3M	
	M12 Connector	43 mm	NO	E2E-X2B1T8-M1	E2E-X2B1D8-M1	E2E-X2C18-M1	
			NC	-	E2E-X2B28-M1	E2E-X2C28-M1	
		53 mm	NO	E2E-X2B1TL8-M1	E2E-X2B1DL8-M1	E2E-X2C1L8-M1	
			NC	-	E2E-X2B2L8-M1	E2E-X2C2L8-M1	
	M8 Connector (4-pin)	39 mm	NO	E2E-X2B1T8-M3	E2E-X2B1D8-M3	E2E-X2C18-M3	
			NC	-	E2E-X2B28-M3	E2E-X2C28-M3	
		49 mm	NO	E2E-X2B1TL8-M3	E2E-X2B1DL8-M3	E2E-X2C1L8-M3	
			NC	-	E2E-X2B2L8-M3	E2E-X2C2L8-M3	
	M8 Connector (3-pin)	39 mm	NO	E2E-X2B1T8-M5	E2E-X2B1D8-M5	E2E-X2C18-M5	
			NC	-	E2E-X2B28-M5	E2E-X2C28-M5	
		49 mm	NO	E2E-X2B1TL8-M5	E2E-X2B1DL8-M5	E2E-X2C1L8-M5	
			NC	-	E2E-X2B2L8-M5	E2E-X2C2L8-M5	
	M12 (4 mm)	Pre-wired (2 m) *1	47 mm *2	NO	E2E-X4B1T12 2M	E2E-X4B1D12 2M	E2E-X4C112 2M
				NC	-	E2E-X4B212 2M	E2E-X4C212 2M
				NO+NC	-	E2E-X4B3D12 2M	E2E-X4C312 2M
			69 mm	NO	E2E-X4B1TL12 2M	E2E-X4B1DL12 2M	E2E-X4C1L12 2M
NC				-	E2E-X4B2L12 2M	E2E-X4C2L12 2M	
NO+NC				-	E2E-X4B3DL12 2M	E2E-X4C3L12 2M	
M12 Pre-wired Smartclick Connector (0.3 m)		47 mm *3	NO	E2E-X4B1T12-M1TJ 0.3M	E2E-X4B1D12-M1TJ 0.3M	E2E-X4C112-M1TJ 0.3M	
			NC	-	E2E-X4B212-M1TJ 0.3M	E2E-X4C212-M1TJ 0.3M	
			NO+NC	-	E2E-X4B3D12-M1TJ 0.3M	E2E-X4C312-M1TJ 0.3M	
		69 mm	NO	E2E-X4B1TL12-M1TJ 0.3M	E2E-X4B1DL12-M1TJ 0.3M	E2E-X4C1L12-M1TJ 0.3M	
			NC	-	E2E-X4B2L12-M1TJ 0.3M	E2E-X4C2L12-M1TJ 0.3M	
			NO+NC	-	E2E-X4B3DL12-M1TJ 0.3M	E2E-X4C3L12-M1TJ 0.3M	
M12 Connector		48 mm	NO	E2E-X4B1T12-M1	E2E-X4B1D12-M1	E2E-X4C112-M1	
			NC	-	E2E-X4B212-M1	E2E-X4C212-M1	
			NO+NC	-	E2E-X4B3D12-M1	E2E-X4C312-M1	
		70 mm	NO	E2E-X4B1TL12-M1	E2E-X4B1DL12-M1	E2E-X4C1L12-M1	
			NC	-	E2E-X4B2L12-M1	E2E-X4C2L12-M1	
			NO+NC	-	E2E-X4B3DL12-M1	E2E-X4C3L12-M1	

E2E/E2EQ NEXT Series DC 3-wire

E2E/E2EQ NEXT Series DC 2-wire

XSS5 NEXT Series

XSS5

XSS3

E2E/E2EQ NEXT Series

BASIC Model

Size (Sensing distance)	Connection method	Body size	Operation mode	Model		
				PNP		NPN
				IO-Link (COM3)	IO-Link (COM2) *4	--- *4
M18 (8 mm)	Pre-wired (2 m) *1	55 mm *2	NO	E2E-X8B1T18 2M	E2E-X8B1D18 2M	E2E-X8C118 2M
			NC	-	E2E-X8B218 2M	E2E-X8C218 2M
			NO+NC	-	E2E-X8B3D18 2M	E2E-X8C318 2M
		77 mm	NO	E2E-X8B1TL18 2M	E2E-X8B1DL18 2M	E2E-X8C1L18 2M
			NC	-	E2E-X8B2L18 2M	E2E-X8C2L18 2M
			NO+NC	-	E2E-X8B3DL18 2M	E2E-X8C3L18 2M
	M12 Pre-wired Smartclick Connector (0.3 m)	55 mm *3	NO	E2E-X8B1T18-M1TJ 0.3M	E2E-X8B1D18-M1TJ 0.3M	E2E-X8C118-M1TJ 0.3M
			NC	-	E2E-X8B218-M1TJ 0.3M	E2E-X8C218-M1TJ 0.3M
			NO+NC	-	E2E-X8B3D18-M1TJ 0.3M	E2E-X8C318-M1TJ 0.3M
		77 mm	NO	E2E-X8B1TL18-M1TJ 0.3M	E2E-X8B1DL18-M1TJ 0.3M	E2E-X8C1L18-M1TJ 0.3M
			NC	-	E2E-X8B2L18-M1TJ 0.3M	E2E-X8C2L18-M1TJ 0.3M
			NO+NC	-	E2E-X8B3DL18-M1TJ 0.3M	E2E-X8C3L18-M1TJ 0.3M
	M12 Connector	53 mm	NO	E2E-X8B1T18-M1	E2E-X8B1D18-M1	E2E-X8C118-M1
			NC	-	E2E-X8B218-M1	E2E-X8C218-M1
			NO+NC	-	E2E-X8B3D18-M1	E2E-X8C318-M1
		75 mm	NO	E2E-X8B1TL18-M1	E2E-X8B1DL18-M1	E2E-X8C1L18-M1
			NC	-	E2E-X8B2L18-M1	E2E-X8C2L18-M1
			NO+NC	-	E2E-X8B3DL18-M1	E2E-X8C3L18-M1
M30 (15 mm)	Pre-wired (2 m) *1	60 mm *2	NO	E2E-X15B1T30 2M	E2E-X15B1D30 2M	E2E-X15C130 2M
			NC	-	E2E-X15B230 2M	E2E-X15C230 2M
			NO+NC	-	E2E-X15B3D30 2M	E2E-X15C330 2M
		82 mm	NO	E2E-X15B1TL30 2M	E2E-X15B1DL30 2M	E2E-X15C1L30 2M
			NC	-	E2E-X15B2L30 2M	E2E-X15C2L30 2M
			NO+NC	-	E2E-X15B3DL30 2M	E2E-X15C3L30 2M
	M12 Pre-wired Smartclick Connector (0.3 m)	60 mm *3	NO	E2E-X15B1T30-M1TJ 0.3M	E2E-X15B1D30-M1TJ 0.3M	E2E-X15C130-M1TJ 0.3M
			NC	-	E2E-X15B230-M1TJ 0.3M	E2E-X15C230-M1TJ 0.3M
			NO+NC	-	E2E-X15B3D30-M1TJ 0.3M	E2E-X15C330-M1TJ 0.3M
		82 mm	NO	E2E-X15B1TL30-M1TJ 0.3M	E2E-X15B1DL30-M1TJ 0.3M	E2E-X15C1L30-M1TJ 0.3M
			NC	-	E2E-X15B2L30-M1TJ 0.3M	E2E-X15C2L30-M1TJ 0.3M
			NO+NC	-	E2E-X15B3DL30-M1TJ 0.3M	E2E-X15C3L30-M1TJ 0.3M
	M12 Connector	58 mm	NO	E2E-X15B1T30-M1	E2E-X15B1D30-M1	E2E-X15C130-M1
			NC	-	E2E-X15B230-M1	E2E-X15C230-M1
			NO+NC	-	E2E-X15B3D30-M1	E2E-X15C330-M1
		80 mm	NO	E2E-X15B1TL30-M1	E2E-X15B1DL30-M1	E2E-X15C1L30-M1
			NC	-	E2E-X15B2L30-M1	E2E-X15C2L30-M1
			NO+NC	-	E2E-X15B3DL30-M1	E2E-X15C3L30-M1

*1. Models with 5-m cable length are also available (Example: E2E-X2B1D8 5M)

*2. Models with 2-m and 5-m robot (bending-resistant) cables are also available with "-R" in the model number. (Example: E2E-X2B1D8-R 2M/ E2E-X2B1D8-R 5M)

*3. Models with M12 Smartclick connector model robot (bending-resistant) cables are also available with "R" in the model number. (Example: E2E-X4B1T12-M1TJR 0.3M)

*4. IO-Link is not supported for NC-type PNP outputs or all types of NPN outputs.

Note: Operation mode NO can be changed to NC via IO-Link communications.

BASIC Model

E2E NEXT Series (Double distance model)

DC 3-wire [Refer to Dimensions on page 65.]

Unshielded

Size (Sensing distance)	Connection method	Body size	Operation mode	Model			
				PNP		NPN	
				IO-Link (COM3)	IO-Link (COM2) *4	--- *4	
M8 (4 mm)	Pre-wired (2 m) *1	38 mm *2	NO	E2E-X4MB1T8 2M	E2E-X4MB1D8 2M	E2E-X4MC18 2M	
			NC	-	E2E-X4MB28 2M	E2E-X4MC28 2M	
		48 mm	NO	E2E-X4MB1TL8 2M	E2E-X4MB1DL8 2M	E2E-X4MC1L8 2M	
			NC	-	E2E-X4MB2L8 2M	E2E-X4MC2L8 2M	
	M12 Pre-wired Smartclick Connector (0.3 m)	38 mm *3	NO	E2E-X4MB1T8-M1TJ 0.3M	E2E-X4MB1D8-M1TJ 0.3M	E2E-X4MC18-M1TJ 0.3M	
			NC	-	E2E-X4MB28-M1TJ 0.3M	E2E-X4MC28-M1TJ 0.3M	
		48 mm	NO	E2E-X4MB1TL8-M1TJ 0.3M	E2E-X4MB1DL8-M1TJ 0.3M	E2E-X4MC1L8-M1TJ 0.3M	
			NC	-	E2E-X4MB2L8-M1TJ 0.3M	E2E-X4MC2L8-M1TJ 0.3M	
	M12 Connector	43 mm	NO	E2E-X4MB1T8-M1	E2E-X4MB1D8-M1	E2E-X4MC18-M1	
			NC	-	E2E-X4MB28-M1	E2E-X4MC28-M1	
		53 mm	NO	E2E-X4MB1TL8-M1	E2E-X4MB1DL8-M1	E2E-X4MC1L8-M1	
			NC	-	E2E-X4MB2L8-M1	E2E-X4MC2L8-M1	
	M8 Connector (4-pin)	39 mm	NO	E2E-X4MB1T8-M3	E2E-X4MB1D8-M3	E2E-X4MC18-M3	
			NC	-	E2E-X4MB28-M3	E2E-X4MC28-M3	
		49 mm	NO	E2E-X4MB1TL8-M3	E2E-X4MB1DL8-M3	E2E-X4MC1L8-M3	
			NC	-	E2E-X4MB2L8-M3	E2E-X4MC2L8-M3	
	M8 Connector (3-pin)	39 mm	NO	E2E-X4MB1T8-M5	E2E-X4MB1D8-M5	E2E-X4MC18-M5	
			NC	-	E2E-X4MB28-M5	E2E-X4MC28-M5	
		49 mm	NO	E2E-X4MB1TL8-M5	E2E-X4MB1DL8-M5	E2E-X4MC1L8-M5	
			NC	-	E2E-X4MB2L8-M5	E2E-X4MC2L8-M5	
	M12 (8 mm)	Pre-wired (2 m) *1	47 mm *2	NO	E2E-X8MB1T12 2M	E2E-X8MB1D12 2M	E2E-X8MC112 2M
				NC	-	E2E-X8MB212 2M	E2E-X8MC212 2M
				NO+NC	-	E2E-X8MB3D12 2M	E2E-X8MC312 2M
			69 mm	NO	E2E-X8MB1TL12 2M	E2E-X8MB1DL12 2M	E2E-X8MC1L12 2M
NC				-	E2E-X8MB2L12 2M	E2E-X8MC2L12 2M	
NO+NC				-	E2E-X8MB3DL12 2M	E2E-X8MC3L12 2M	
M12 Pre-wired Smartclick Connector (0.3 m)		47 mm *3	NO	E2E-X8MB1T12-M1TJ 0.3M	E2E-X8MB1D12-M1TJ 0.3M	E2E-X8MC112-M1TJ 0.3M	
			NC	-	E2E-X8MB212-M1TJ 0.3M	E2E-X8MC212-M1TJ 0.3M	
			NO+NC	-	E2E-X8MB3D12-M1TJ 0.3M	E2E-X8MC312-M1TJ 0.3M	
		69 mm	NO	E2E-X8MB1TL12-M1TJ 0.3M	E2E-X8MB1DL12-M1TJ 0.3M	E2E-X8MC1L12-M1TJ 0.3M	
			NC	-	E2E-X8MB2L12-M1TJ 0.3M	E2E-X8MC2L12-M1TJ 0.3M	
			NO+NC	-	E2E-X8MB3DL12-M1TJ 0.3M	E2E-X8MC3L12-M1TJ 0.3M	
M12 Connector		48 mm	NO	E2E-X8MB1T12-M1	E2E-X8MB1D12-M1	E2E-X8MC112-M1	
			NC	-	E2E-X8MB212-M1	E2E-X8MC212-M1	
			NO+NC	-	E2E-X8MB3D12-M1	E2E-X8MC312-M1	
		70 mm	NO	E2E-X8MB1TL12-M1	E2E-X8MB1DL12-M1	E2E-X8MC1L12-M1	
	NC		-	E2E-X8MB2L12-M1	E2E-X8MC2L12-M1		
	NO+NC		-	E2E-X8MB3DL12-M1	E2E-X8MC3L12-M1		

E2E/E2EQ NEXT Series DC 3-wire

E2E/E2EQ NEXT Series DC 2-wire

XSS5 NEXT Series

XSS5

XSS3

E2E/E2EQ NEXT Series

BASIC Model

Size (Sensing distance)	Connection method	Body size	Operation mode	Model		
				PNP		NPN
				IO-Link (COM3)	IO-Link (COM2) *4	--- *4
M18 (16 mm)	Pre-wired (2 m) *1	55 mm *2	NO	E2E-X16MB1T18 2M	E2E-X16MB1D18 2M	E2E-X16MC118 2M
			NC	-	E2E-X16MB218 2M	E2E-X16MC218 2M
			NO+NC	-	E2E-X16MB3D18 2M	E2E-X16MC318 2M
		77 mm	NO	E2E-X16MB1TL18 2M	E2E-X16MB1DL18 2M	E2E-X16MC1L18 2M
			NC	-	E2E-X16MB2L18 2M	E2E-X16MC2L18 2M
			NO+NC	-	E2E-X16MB3DL18 2M	E2E-X16MC3L18 2M
	M12 Pre-wired Smartclick Connector (0.3 m)	55 mm *3	NO	E2E-X16MB1T18-M1TJ 0.3M	E2E-X16MB1D18-M1TJ 0.3M	E2E-X16MC118-M1TJ 0.3M
			NC	-	E2E-X16MB218-M1TJ 0.3M	E2E-X16MC218-M1TJ 0.3M
			NO+NC	-	E2E-X16MB3D18-M1TJ 0.3M	E2E-X16MC318-M1TJ 0.3M
		77 mm	NO	E2E-X16MB1TL18-M1TJ 0.3M	E2E-X16MB1DL18-M1TJ 0.3M	E2E-X16MC1L18-M1TJ 0.3M
			NC	-	E2E-X16MB2L18-M1TJ 0.3M	E2E-X16MC2L18-M1TJ 0.3M
			NO+NC	-	E2E-X16MB3DL18-M1TJ 0.3M	E2E-X16MC3L18-M1TJ 0.3M
	M12 Connector	53 mm	NO	E2E-X16MB1T18-M1	E2E-X16MB1D18-M1	E2E-X16MC118-M1
			NC	-	E2E-X16MB218-M1	E2E-X16MC218-M1
			NO+NC	-	E2E-X16MB3D18-M1	E2E-X16MC318-M1
		75 mm	NO	E2E-X16MB1TL18-M1	E2E-X16MB1DL18-M1	E2E-X16MC1L18-M1
			NC	-	E2E-X16MB2L18-M1	E2E-X16MC2L18-M1
			NO+NC	-	E2E-X16MB3DL18-M1	E2E-X16MC3L18-M1
M30 (30 mm)	Pre-wired (2 m) *1	82 mm *2	NO	E2E-X30MB1TL30 2M	E2E-X30MB1DL30 2M	E2E-X30MC1L30 2M
			NC	-	E2E-X30MB2L30 2M	E2E-X30MC2L30 2M
			NO+NC	-	E2E-X30MB3DL30 2M	E2E-X30MC3L30 2M
	M12 Pre-wired Smartclick Connector (0.3 m)	82 mm *3	NO	E2E-X30MB1TL30-M1TJ 0.3M	E2E-X30MB1DL30-M1TJ 0.3M	E2E-X30MC1L30-M1TJ 0.3M
			NC	-	E2E-X30MB2L30-M1TJ 0.3M	E2E-X30MC2L30-M1TJ 0.3M
			NO+NC	-	E2E-X30MB3DL30-M1TJ 0.3M	E2E-X30MC3L30-M1TJ 0.3M
	M12 Connector	80 mm	NO	E2E-X30MB1TL30-M1	E2E-X30MB1DL30-M1	E2E-X30MC1L30-M1
			NC	-	E2E-X30MB2L30-M1	E2E-X30MC2L30-M1
			NO+NC	-	E2E-X30MB3DL30-M1	E2E-X30MC3L30-M1

*1. Models with 5-m cable length are also available (Example: E2E-X8MB1D12 5M)

*2. Models with 2-m and 5-m robot (bending-resistant) cables are also available with "-R" in the model number. (Example: E2E-X8MB1D12-R 2M/ E2E-X8MB1D12-R 5M)

*3. Models with M12 Smartclick connector model robot (bending-resistant) cables are also available with "R" in the model number. (Example: E2E-X8MB1D12-M1TJR 0.3M)

*4. IO-Link is not supported for NC-type PNP outputs or all types of NPN outputs.

Note: Operation mode NO can be changed to NC via IO-Link communications.

BASIC Model

E2E NEXT Series (Single distance model)

DC 3-wire [Refer to Dimensions on page 65.]

Shielded

Size (Sensing distance)	Connection method	Body size	Operation mode	Model			
				PNP		NPN	
				IO-Link (COM3)	IO-Link (COM2) *4	--- *4	
M8 (1.5 mm)	Pre-wired (2 m) *1	38 mm *2	NO	E2E-X1R5B1T8 2M	E2E-X1R5B1D8 2M	E2E-X1R5C18 2M	
			NC	-	E2E-X1R5B28 2M	E2E-X1R5C28 2M	
		48 mm	NO	E2E-X1R5B1TL8 2M	E2E-X1R5B1DL8 2M	E2E-X1R5C1L8 2M	
			NC	-	E2E-X1R5B2L8 2M	E2E-X1R5C2L8 2M	
	M12 Pre-wired Smartclick Connector (0.3 m)	38 mm *3	NO	E2E-X1R5B1T8-M1TJ 0.3M	E2E-X1R5B1D8-M1TJ 0.3M	E2E-X1R5C18-M1TJ 0.3M	
			NC	-	E2E-X1R5B28-M1TJ 0.3M	E2E-X1R5C28-M1TJ 0.3M	
		48 mm	NO	E2E-X1R5B1TL8-M1TJ 0.3M	E2E-X1R5B1DL8-M1TJ 0.3M	E2E-X1R5C1L8-M1TJ 0.3M	
			NC	-	E2E-X1R5B2L8-M1TJ 0.3M	E2E-X1R5C2L8-M1TJ 0.3M	
	M12 Connector	43 mm	NO	E2E-X1R5B1T8-M1	E2E-X1R5B1D8-M1	E2E-X1R5C18-M1	
			NC	-	E2E-X1R5B28-M1	E2E-X1R5C28-M1	
			53 mm	NO	E2E-X1R5B1TL8-M1	E2E-X1R5B1DL8-M1	E2E-X1R5C1L8-M1
				NC	-	E2E-X1R5B2L8-M1	E2E-X1R5C2L8-M1
	M8 Connector (4-pin)	39 mm	NO	E2E-X1R5B1T8-M3	E2E-X1R5B1D8-M3	E2E-X1R5C18-M3	
			NC	-	E2E-X1R5B28-M3	E2E-X1R5C28-M3	
		49 mm	NO	E2E-X1R5B1TL8-M3	E2E-X1R5B1DL8-M3	E2E-X1R5C1L8-M3	
			NC	-	E2E-X1R5B2L8-M3	E2E-X1R5C2L8-M3	
	M8 Connector (3-pin)	39 mm	NO	E2E-X1R5B1T8-M5	E2E-X1R5B1D8-M5	E2E-X1R5C18-M5	
			NC	-	E2E-X1R5B28-M5	E2E-X1R5C28-M5	
		49 mm	NO	E2E-X1R5B1TL8-M5	E2E-X1R5B1DL8-M5	E2E-X1R5C1L8-M5	
			NC	-	E2E-X1R5B2L8-M5	E2E-X1R5C2L8-M5	
	M12 (2 mm)	Pre-wired (2 m) *1	47 mm *2	NO	E2E-X2B1T12 2M	E2E-X2B1D12 2M	E2E-X2C112 2M
				NC	-	E2E-X2B212 2M	E2E-X2C212 2M
				NO+NC	-	E2E-X2B3D12 2M	E2E-X2C312 2M
			69 mm	NO	E2E-X2B1TL12 2M	E2E-X2B1DL12 2M	E2E-X2C1L12 2M
NC				-	E2E-X2B2L12 2M	E2E-X2C2L12 2M	
NO+NC				-	E2E-X2B3DL12 2M	E2E-X2C3L12 2M	
M12 Pre-wired Smartclick Connector (0.3 m)		47 mm *3	NO	E2E-X2B1T12-M1TJ 0.3M	E2E-X2B1D12-M1TJ 0.3M	E2E-X2C112-M1TJ 0.3M	
			NC	-	E2E-X2B212-M1TJ 0.3M	E2E-X2C212-M1TJ 0.3M	
			NO+NC	-	E2E-X2B3D12-M1TJ 0.3M	E2E-X2C312-M1TJ 0.3M	
		69 mm	NO	E2E-X2B1TL12-M1TJ 0.3M	E2E-X2B1DL12-M1TJ 0.3M	E2E-X2C1L12-M1TJ 0.3M	
			NC	-	E2E-X2B2L12-M1TJ 0.3M	E2E-X2C2L12-M1TJ 0.3M	
			NO+NC	-	E2E-X2B3DL12-M1TJ 0.3M	E2E-X2C3L12-M1TJ 0.3M	
M12 Connector		48 mm	NO	E2E-X2B1T12-M1	E2E-X2B1D12-M1	E2E-X2C112-M1	
			NC	-	E2E-X2B212-M1	E2E-X2C212-M1	
			NO+NC	-	E2E-X2B3D12-M1	E2E-X2C312-M1	
		70 mm	NO	E2E-X2B1TL12-M1	E2E-X2B1DL12-M1	E2E-X2C1L12-M1	
	NC		-	E2E-X2B2L12-M1	E2E-X2C2L12-M1		
	NO+NC		-	E2E-X2B3DL12-M1	E2E-X2C3L12-M1		

E2E/E2EQ NEXT Series DC 3-wire

E2E/E2EQ NEXT Series DC 2-wire

XSS5 NEXT Series

XSS5

XSS3

E2E/E2EQ NEXT Series

BASIC Model

Size (Sensing distance)	Connection method	Body size	Operation mode	Model		
				PNP		NPN --- *4
				IO-Link (COM3)	IO-Link (COM2) *4	
M18 (5 mm)	Pre-wired (2 m) *1	55 mm *2	NO	E2E-X5B1T18 2M	E2E-X5B1D18 2M	E2E-X5C118 2M
			NC	-	E2E-X5B218 2M	E2E-X5C218 2M
			NO+NC	-	E2E-X5B3D18 2M	E2E-X5C318 2M
		77 mm	NO	E2E-X5B1TL18 2M	E2E-X5B1DL18 2M	E2E-X5C1L18 2M
			NC	-	E2E-X5B2L18 2M	E2E-X5C2L18 2M
			NO+NC	-	E2E-X5B3DL18 2M	E2E-X5C3L18 2M
	M12 Pre-wired Smartclick Connector (0.3 m)	55 mm *3	NO	E2E-X5B1T18-M1TJ 0.3M	E2E-X5B1D18-M1TJ 0.3M	E2E-X5C118-M1TJ 0.3M
			NC	-	E2E-X5B218-M1TJ 0.3M	E2E-X5C218-M1TJ 0.3M
			NO+NC	-	E2E-X5B3D18-M1TJ 0.3M	E2E-X5C318-M1TJ 0.3M
		77 mm	NO	E2E-X5B1TL18-M1TJ 0.3M	E2E-X5B1DL18-M1TJ 0.3M	E2E-X5C1L18-M1TJ 0.3M
			NC	-	E2E-X5B2L18-M1TJ 0.3M	E2E-X5C2L18-M1TJ 0.3M
			NO+NC	-	E2E-X5B3DL18-M1TJ 0.3M	E2E-X5C3L18-M1TJ 0.3M
	M12 Connector	53 mm	NO	E2E-X5B1T18-M1	E2E-X5B1D18-M1	E2E-X5C118-M1
			NC	-	E2E-X5B218-M1	E2E-X5C218-M1
			NO+NC	-	E2E-X5B3D18-M1	E2E-X5C318-M1
		75 mm	NO	E2E-X5B1TL18-M1	E2E-X5B1DL18-M1	E2E-X5C1L18-M1
			NC	-	E2E-X5B2L18-M1	E2E-X5C2L18-M1
			NO+NC	-	E2E-X5B3DL18-M1	E2E-X5C3L18-M1
M30 (10 mm)	Pre-wired (2 m) *1	60 mm *2	NO	E2E-X10B1T30 2M	E2E-X10B1D30 2M	E2E-X10C130 2M
			NC	-	E2E-X10B230 2M	E2E-X10C230 2M
			NO+NC	-	E2E-X10B3D30 2M	E2E-X10C330 2M
		82 mm	NO	E2E-X10B1TL30 2M	E2E-X10B1DL30 2M	E2E-X10C1L30 2M
			NC	-	E2E-X10B2L30 2M	E2E-X10C2L30 2M
			NO+NC	-	E2E-X10B3DL30 2M	E2E-X10C3L30 2M
	M12 Pre-wired Smartclick Connector (0.3 m)	60 mm *3	NO	E2E-X10B1T30-M1TJ 0.3M	E2E-X10B1D30-M1TJ 0.3M	E2E-X10C130-M1TJ 0.3M
			NC	-	E2E-X10B230-M1TJ 0.3M	E2E-X10C230-M1TJ 0.3M
			NO+NC	-	E2E-X10B3D30-M1TJ 0.3M	E2E-X10C330-M1TJ 0.3M
		82 mm	NO	E2E-X10B1TL30-M1TJ 0.3M	E2E-X10B1DL30-M1TJ 0.3M	E2E-X10C1L30-M1TJ 0.3M
			NC	-	E2E-X10B2L30-M1TJ 0.3M	E2E-X10C2L30-M1TJ 0.3M
			NO+NC	-	E2E-X10B3DL30-M1TJ 0.3M	E2E-X10C3L30-M1TJ 0.3M
	M12 Connector	58 mm	NO	E2E-X10B1T30-M1	E2E-X10B1D30-M1	E2E-X10C130-M1
			NC	-	E2E-X10B230-M1	E2E-X10C230-M1
			NO+NC	-	E2E-X10B3D30-M1	E2E-X10C330-M1
		80 mm	NO	E2E-X10B1TL30-M1	E2E-X10B1DL30-M1	E2E-X10C1L30-M1
			NC	-	E2E-X10B2L30-M1	E2E-X10C2L30-M1
			NO+NC	-	E2E-X10B3DL30-M1	E2E-X10C3L30-M1

*1. Models with 5-m cable length are also available (Example: E2E-X2B1D12 5M)

*2. Models with 2-m and 5-m robot (bending-resistant) cables are also available with "-R" in the model number. (Example: E2E-X2B1D12-R 2M/ E2E-X2B1D12-R 5M)

*3. Models with M12 Smartclick connector model robot (bending-resistant) cables are also available with "R" in the model number. (Example: E2E-X2B1D12-M1TJR 0.3M)

*4. IO-Link is not supported for NC-type PNP outputs or all types of NPN outputs.

Note: Operation mode NO can be changed to NC via IO-Link communications.

BASIC Model

E2E NEXT Series (Single distance model)

DC 3-wire [Refer to Dimensions on page 65.]

Unshielded

Size (Sensing distance)	Connection method	Body size	Operation mode	Model			
				PNP		NPN	
				IO-Link (COM3)	IO-Link (COM2) *4	--- *4	
M8 (2mm)	Pre-wired (2 m) *1	38 mm *2	NO	E2E-X2MB1T8 2M	E2E-X2MB1D8 2M	E2E-X2MC18 2M	
			NC	-	E2E-X2MB28 2M	E2E-X2MC28 2M	
		48 mm	NO	E2E-X2MB1TL8 2M	E2E-X2MB1DL8 2M	E2E-X2MC1L8 2M	
			NC	-	E2E-X2MB2L8 2M	E2E-X2MC2L8 2M	
	M12 Pre-wired Smartclick Connector (0.3 m)	38 mm *3	NO	E2E-X2MB1T8-M1TJ 0.3M	E2E-X2MB1D8-M1TJ 0.3M	E2E-X2MC18-M1TJ 0.3M	
			NC	-	E2E-X2MB28-M1TJ 0.3M	E2E-X2MC28-M1TJ 0.3M	
		48 mm	NO	E2E-X2MB1TL8-M1TJ 0.3M	E2E-X2MB1DL8-M1TJ 0.3M	E2E-X2MC1L8-M1TJ 0.3M	
			NC	-	E2E-X2MB2L8-M1TJ 0.3M	E2E-X2MC2L8-M1TJ 0.3M	
	M12 Connector	43 mm	NO	E2E-X2MB1T8-M1	E2E-X2MB1D8-M1	E2E-X2MC18-M1	
			NC	-	E2E-X2MB28-M1	E2E-X2MC28-M1	
		53 mm	NO	E2E-X2MB1TL8-M1	E2E-X2MB1DL8-M1	E2E-X2MC1L8-M1	
			NC	-	E2E-X2MB2L8-M1	E2E-X2MC2L8-M1	
	M8 Connector (4-pin)	39 mm	NO	E2E-X2MB1T8-M3	E2E-X2MB1D8-M3	E2E-X2MC18-M3	
			NC	-	E2E-X2MB28-M3	E2E-X2MC28-M3	
		49 mm	NO	E2E-X2MB1TL8-M3	E2E-X2MB1DL8-M3	E2E-X2MC1L8-M3	
			NC	-	E2E-X2MB2L8-M3	E2E-X2MC2L8-M3	
	M8 Connector (3-pin)	39 mm	NO	E2E-X2MB1T8-M5	E2E-X2MB1D8-M5	E2E-X2MC18-M5	
			NC	-	E2E-X2MB28-M5	E2E-X2MC28-M5	
		49 mm	NO	E2E-X2MB1TL8-M5	E2E-X2MB1DL8-M5	E2E-X2MC1L8-M5	
			NC	-	E2E-X2MB2L8-M5	E2E-X2MC2L8-M5	
	M12 (5mm)	Pre-wired (2 m) *1	47 mm *2	NO	E2E-X5MB1T12 2M	E2E-X5MB1D12 2M	E2E-X5MC112 2M
				NC	-	E2E-X5MB212 2M	E2E-X5MC212 2M
				NO+NC	-	E2E-X5MB3D12 2M	E2E-X5MC312 2M
			69 mm	NO	E2E-X5MB1TL12 2M	E2E-X5MB1DL12 2M	E2E-X5MC1L12 2M
NC				-	E2E-X5MB2L12 2M	E2E-X5MC2L12 2M	
NO+NC				-	E2E-X5MB3DL12 2M	E2E-X5MC3L12 2M	
M12 Pre-wired Smartclick Connector (0.3 m)			47 mm *3	NO	E2E-X5MB1T12-M1TJ 0.3M	E2E-X5MB1D12-M1TJ 0.3M	E2E-X5MC112-M1TJ 0.3M
				NC	-	E2E-X5MB212-M1TJ 0.3M	E2E-X5MC212-M1TJ 0.3M
		NO+NC		-	E2E-X5MB3D12-M1TJ 0.3M	E2E-X5MC312-M1TJ 0.3M	
		69 mm	NO	E2E-X5MB1TL12-M1TJ 0.3M	E2E-X5MB1DL12-M1TJ 0.3M	E2E-X5MC1L12-M1TJ 0.3M	
			NC	-	E2E-X5MB2L12-M1TJ 0.3M	E2E-X5MC2L12-M1TJ 0.3M	
			NO+NC	-	E2E-X5MB3DL12-M1TJ 0.3M	E2E-X5MC3L12-M1TJ 0.3M	
M12 Connector		48 mm	NO	E2E-X5MB1T12-M1	E2E-X5MB1D12-M1	E2E-X5MC112-M1	
			NC	-	E2E-X5MB212-M1	E2E-X5MC212-M1	
			NO+NC	-	E2E-X5MB3D12-M1	E2E-X5MC312-M1	
		70 mm	NO	E2E-X5MB1TL12-M1	E2E-X5MB1DL12-M1	E2E-X5MC1L12-M1	
			NC	-	E2E-X5MB2L12-M1	E2E-X5MC2L12-M1	
			NO+NC	-	E2E-X5MB3DL12-M1	E2E-X5MC3L12-M1	

E2E/E2EQ NEXT Series DC 3-wire

E2E/E2EQ NEXT Series DC 2-wire

X55 NEXT Series

X55

X53

E2E/E2EQ NEXT Series

BASIC Model

Size (Sensing distance)	Connection method	Body size	Operation mode	Model		
				PNP		NPN
				IO-Link (COM3)	IO-Link (COM2) *4	--- *4
M18 (10mm)	Pre-wired (2 m) *1	55 mm *2	NO	E2E-X10MB1T18 2M	E2E-X10MB1D18 2M	E2E-X10MC118 2M
			NC	-	E2E-X10MB218 2M	E2E-X10MC218 2M
			NO+NC	-	E2E-X10MB3D18 2M	E2E-X10MC318 2M
		77 mm	NO	E2E-X10MB1TL18 2M	E2E-X10MB1DL18 2M	E2E-X10MC1L18 2M
			NC	-	E2E-X10MB2L18 2M	E2E-X10MC2L18 2M
			NO+NC	-	E2E-X10MB3DL18 2M	E2E-X10MC3L18 2M
	M12 Pre-wired Smartclick Connector (0.3 m)	55 mm *3	NO	E2E-X10MB1T18-M1TJ 0.3M	E2E-X10MB1D18-M1TJ 0.3M	E2E-X10MC118-M1TJ 0.3M
			NC	-	E2E-X10MB218-M1TJ 0.3M	E2E-X10MC218-M1TJ 0.3M
			NO+NC	-	E2E-X10MB3D18-M1TJ 0.3M	E2E-X10MC318-M1TJ 0.3M
		77 mm	NO	E2E-X10MB1TL18-M1TJ 0.3M	E2E-X10MB1DL18-M1TJ 0.3M	E2E-X10MC1L18-M1TJ 0.3M
			NC	-	E2E-X10MB2L18-M1TJ 0.3M	E2E-X10MC2L18-M1TJ 0.3M
			NO+NC	-	E2E-X10MB3DL18-M1TJ 0.3M	E2E-X10MC3L18-M1TJ 0.3M
	M12 Connector	53 mm	NO	E2E-X10MB1T18-M1	E2E-X10MB1D18-M1	E2E-X10MC118-M1
			NC	-	E2E-X10MB218-M1	E2E-X10MC218-M1
			NO+NC	-	E2E-X10MB3D18-M1	E2E-X10MC318-M1
		75 mm	NO	E2E-X10MB1TL18-M1	E2E-X10MB1DL18-M1	E2E-X10MC1L18-M1
			NC	-	E2E-X10MB2L18-M1	E2E-X10MC2L18-M1
			NO+NC	-	E2E-X10MB3DL18-M1	E2E-X10MC3L18-M1
M30 (18mm)	Pre-wired (2 m) *1	60 mm *2	NO	E2E-X18MB1T30 2M	E2E-X18MB1D30 2M	E2E-X18MC130 2M
			NC	-	E2E-X18MB230 2M	E2E-X18MC230 2M
			NO+NC	-	E2E-X18MB3D30 2M	E2E-X18MC330 2M
		82 mm	NO	E2E-X18MB1TL30 2M	E2E-X18MB1DL30 2M	E2E-X18MC1L30 2M
			NC	-	E2E-X18MB2L30 2M	E2E-X18MC2L30 2M
			NO+NC	-	E2E-X18MB3DL30 2M	E2E-X18MC3L30 2M
	M12 Pre-wired Smartclick Connector (0.3 m)	60 mm *3	NO	E2E-X18MB1T30-M1TJ 0.3M	E2E-X18MB1D30-M1TJ 0.3M	E2E-X18MC130-M1TJ 0.3M
			NC	-	E2E-X18MB230-M1TJ 0.3M	E2E-X18MC230-M1TJ 0.3M
			NO+NC	-	E2E-X18MB3D30-M1TJ 0.3M	E2E-X18MC330-M1TJ 0.3M
		82 mm	NO	E2E-X18MB1TL30-M1TJ 0.3M	E2E-X18MB1DL30-M1TJ 0.3M	E2E-X18MC1L30-M1TJ 0.3M
			NC	-	E2E-X18MB2L30-M1TJ 0.3M	E2E-X18MC2L30-M1TJ 0.3M
			NO+NC	-	E2E-X18MB3DL30-M1TJ 0.3M	E2E-X18MC3L30-M1TJ 0.3M
	M12 Connector	58 mm	NO	E2E-X18MB1T30-M1	E2E-X18MB1D30-M1	E2E-X18MC130-M1
			NC	-	E2E-X18MB230-M1	E2E-X18MC230-M1
			NO+NC	-	E2E-X18MB3D30-M1	E2E-X18MC330-M1
		80 mm	NO	E2E-X18MB1TL30-M1	E2E-X18MB1DL30-M1	E2E-X18MC1L30-M1
			NC	-	E2E-X18MB2L30-M1	E2E-X18MC2L30-M1
			NO+NC	-	E2E-X18MB3DL30-M1	E2E-X18MC3L30-M1

*1. Models with 5-m cable length are also available (Example: E2E-X5MB1D12 5M)

*2. Models with 2-m and 5-m robot (bending-resistant) cables are also available with "-R" in the model number. (Example: E2E-X5MB1D12-R 2M/E2E-X5MB1D12-R 5M)

*3. Models with M12 Smartclick connector model robot (bending-resistant) cables are also available with "R" in the model number. (Example: E2E-X5MB1D12-M1TJR 2M)

*4. IO-Link is not supported for NC-type PNP outputs or all types of NPN outputs.

Note: Operation mode NO can be changed to NC via IO-Link communications.

BASIC Model

E2EQ NEXT Series (Spatter-resistant Double distance model)

DC 3-wire [Refer to *Dimensions* on page 65.]

Shielded

Size (Sensing distance)	Connection method	Body size	Operation mode	Model		
				PNP		NPN
				IO-Link (COM3)	IO-Link (COM2) *2	--- *2
M8 (2 mm)	Pre-wired (2 m) *1	38 mm	NO	E2EQ-X2B1T8 2M	E2EQ-X2B1D8 2M	E2EQ-X2C18 2M
			NC	-	E2EQ-X2B28 2M	E2EQ-X2C28 2M
	M12 Pre-wired Smartclick Connector (0.3 m)	38 mm	NO	E2EQ-X2B1T8-M1TJ 0.3M	E2EQ-X2B1D8-M1TJ 0.3M	E2EQ-X2C18-M1TJ 0.3M
			NC	-	E2EQ-X2B28-M1TJ 0.3M	E2EQ-X2C28-M1TJ 0.3M
	M12 Connector	43 mm	NO	E2EQ-X2B1T8-M1	E2EQ-X2B1D8-M1	E2EQ-X2C18-M1
			NC	-	E2EQ-X2B28-M1	E2EQ-X2C28-M1
M12 (4 mm)	Pre-wired (2 m) *1	47 mm	NO	E2EQ-X4B1T12 2M	E2EQ-X4B1D12 2M	E2EQ-X4C112 2M
			NC	-	E2EQ-X4B212 2M	E2EQ-X4C212 2M
			NO+NC	-	E2EQ-X4B3D12 2M	E2EQ-X4C312 2M
	M12 Pre-wired Smartclick Connector (0.3 m)	47 mm	NO	E2EQ-X4B1T12-M1TJ 0.3M	E2EQ-X4B1D12-M1TJ 0.3M	E2EQ-X4C112-M1TJ 0.3M
			NC	-	E2EQ-X4B212-M1TJ 0.3M	E2EQ-X4C212-M1TJ 0.3M
			NO+NC	-	E2EQ-X4B3D12-M1TJ 0.3M	E2EQ-X4C312-M1TJ 0.3M
	M12 Connector	48 mm	NO	E2EQ-X4B1T12-M1	E2EQ-X4B1D12-M1	E2EQ-X4C112-M1
			NC	-	E2EQ-X4B212-M1	E2EQ-X4C212-M1
			NO+NC	-	E2EQ-X4B3D12-M1	E2EQ-X4C312-M1
M18 (8 mm)	Pre-wired (2 m) *1	55 mm	NO	E2EQ-X8B1T18 2M	E2EQ-X8B1D18 2M	E2EQ-X8C118 2M
			NC	-	E2EQ-X8B218 2M	E2EQ-X8C218 2M
			NO+NC	-	E2EQ-X8B3D18 2M	E2EQ-X8C318 2M
	M12 Pre-wired Smartclick Connector (0.3 m)	55 mm	NO	E2EQ-X8B1T18-M1TJ 0.3M	E2EQ-X8B1D18-M1TJ 0.3M	E2EQ-X8C118-M1TJ 0.3M
			NC	-	E2EQ-X8B218-M1TJ 0.3M	E2EQ-X8C218-M1TJ 0.3M
			NO+NC	-	E2EQ-X8B3D18-M1TJ 0.3M	E2EQ-X8C318-M1TJ 0.3M
	M12 Connector	53 mm	NO	E2EQ-X8B1T18-M1	E2EQ-X8B1D18-M1	E2EQ-X8C118-M1
			NC	-	E2EQ-X8B218-M1	E2EQ-X8C218-M1
			NO+NC	-	E2EQ-X8B3D18-M1	E2EQ-X8C318-M1
M30 (15 mm)	Pre-wired (2 m) *1	60 mm	NO	E2EQ-X15B1T30 2M	E2EQ-X15B1D30 2M	E2EQ-X15C130 2M
			NC	-	E2EQ-X15B230 2M	E2EQ-X15C230 2M
			NO+NC	-	E2EQ-X15B3D30 2M	E2EQ-X15C330 2M
	M12 Pre-wired Smartclick Connector (0.3 m)	60 mm	NO	E2EQ-X15B1T30-M1TJ 0.3M	E2EQ-X15B1D30-M1TJ 0.3M	E2EQ-X15C130-M1TJ 0.3M
			NC	-	E2EQ-X15B230-M1TJ 0.3M	E2EQ-X15C230-M1TJ 0.3M
			NO+NC	-	E2EQ-X15B3D30-M1TJ 0.3M	E2EQ-X15C330-M1TJ 0.3M
	M12 Connector	58 mm	NO	E2EQ-X15B1T30-M1	E2EQ-X15B1D30-M1	E2EQ-X15C130-M1
			NC	-	E2EQ-X15B230-M1	E2EQ-X15C230-M1
			NO+NC	-	E2EQ-X15B3D30-M1	E2EQ-X15C330-M1

*1. Models with 5-m cable length are also available (Example: E2EQ-X6B1D12 5M)

*2. IO-Link is not supported for NC-type PNP outputs or all types of NPN outputs.

Note: Operation mode NO can be changed to NC via IO-Link communications.

E2E/E2EQ NEXT Series DC 3-wire

E2E/E2EQ NEXT Series DC 2-wire

XSS NEXT Series

XSS

XSS

E2E/E2EQ NEXT Series

BASIC Model

E2EQ NEXT Series (Spatter-resistant Single distance model)

DC 3-wire [Refer to *Dimensions* on page 65.]

Shielded

Size (Sensing distance)	Connection method	Body size	Operation mode	Model		
				PNP		NPN
				IO-Link (COM3)	IO-Link (COM2) *2	--- *2
M8 (1.5 mm)	Pre-wired (2 m) *1	38 mm	NO	E2EQ-X1R5B1T8 2M	E2EQ-X1R5B1D8 2M	E2EQ-X1R5C18 2M
			NC	-	E2EQ-X1R5B28 2M	E2EQ-X1R5C28 2M
	M12 Pre-wired Smartclick Connector (0.3 m)	38 mm	NO	E2EQ-X1R5B1T8-M1TJ 0.3M	E2EQ-X1R5B1D8-M1TJ 0.3M	E2EQ-X1R5C18-M1TJ 0.3M
			NC	-	E2EQ-X1R5B28-M1TJ 0.3M	E2EQ-X1R5C28-M1TJ 0.3M
	M12 Connector	43 mm	NO	E2EQ-X1R5B1T8-M1	E2EQ-X1R5B1D8-M1	E2EQ-X1R5C18-M1
			NC	-	E2EQ-X1R5B28-M1	E2EQ-X1R5C28-M1
M12 (2 mm)	Pre-wired (2 m) *1	47 mm	NO	E2EQ-X2B1T12 2M	E2EQ-X2B1D12 2M	E2EQ-X2C112 2M
			NC	-	E2EQ-X2B212 2M	E2EQ-X2C212 2M
			NO+NC	-	E2EQ-X2B3D12 2M	E2EQ-X2C312 2M
	M12 Pre-wired Smartclick Connector (0.3 m)	47 mm	NO	E2EQ-X2B1T12-M1TJ 0.3M	E2EQ-X2B1D12-M1TJ 0.3M	E2EQ-X2C112-M1TJ 0.3M
			NC	-	E2EQ-X2B212-M1TJ 0.3M	E2EQ-X2C212-M1TJ 0.3M
			NO+NC	-	E2EQ-X2B3D12-M1TJ 0.3M	E2EQ-X2C312-M1TJ 0.3M
	M12 Connector	48 mm	NO	E2EQ-X2B1T12-M1	E2EQ-X2B1D12-M1	E2EQ-X2C112-M1
			NC	-	E2EQ-X2B212-M1	E2EQ-X2C212-M1
			NO+NC	-	E2EQ-X2B3D12-M1	E2EQ-X2C312-M1
M18 (5 mm)	Pre-wired (2 m) *1	55 mm	NO	E2EQ-X5B1T18 2M	E2EQ-X5B1D18 2M	E2EQ-X5C118 2M
			NC	-	E2EQ-X5B218 2M	E2EQ-X5C218 2M
			NO+NC	-	E2EQ-X5B3D18 2M	E2EQ-X5C318 2M
	M12 Pre-wired Smartclick Connector (0.3 m)	55 mm	NO	E2EQ-X5B1T18-M1TJ 0.3M	E2EQ-X5B1D18-M1TJ 0.3M	E2EQ-X5C118-M1TJ 0.3M
			NC	-	E2EQ-X5B218-M1TJ 0.3M	E2EQ-X5C218-M1TJ 0.3M
			NO+NC	-	E2EQ-X5B3D18-M1TJ 0.3M	E2EQ-X5C318-M1TJ 0.3M
	M12 Connector	53 mm	NO	E2EQ-X5B1T18-M1	E2EQ-X5B1D18-M1	E2EQ-X5C118-M1
			NC	-	E2EQ-X5B218-M1	E2EQ-X5C218-M1
			NO+NC	-	E2EQ-X5B3D18-M1	E2EQ-X5C318-M1
M30 (10 mm)	Pre-wired (2 m) *1	60 mm	NO	E2EQ-X10B1T30 2M	E2EQ-X10B1D30 2M	E2EQ-X10C130 2M
			NC	-	E2EQ-X10B230 2M	E2EQ-X10C230 2M
			NO+NC	-	E2EQ-X10B3D30 2M	E2EQ-X10C330 2M
	M12 Pre-wired Smartclick Connector (0.3 m)	60 mm	NO	E2EQ-X10B1T30-M1TJ 0.3M	E2EQ-X10B1D30-M1TJ 0.3M	E2EQ-X10C130-M1TJ 0.3M
			NC	-	E2EQ-X10B230-M1TJ 0.3M	E2EQ-X10C230-M1TJ 0.3M
			NO+NC	-	E2EQ-X10B3D30-M1TJ 0.3M	E2EQ-X10C330-M1TJ 0.3M
	M12 Connector	58 mm	NO	E2EQ-X10B1T30-M1	E2EQ-X10B1D30-M1	E2EQ-X10C130-M1
			NC	-	E2EQ-X10B230-M1	E2EQ-X10C230-M1
			NO+NC	-	E2EQ-X10B3D30-M1	E2EQ-X10C330-M1

*1. Models with 5-m cable length are also available (Example: E2EQ-X6B1D12 5M)

*2. IO-Link is not supported for NC-type PNP outputs or all types of NPN outputs.

Note: Operation mode NO can be changed to NC via IO-Link communications.

Accessories (Sold Separately)

Sensor I/O Connectors



(Models for Pre-wired Connectors) A Sensor I/O Connector is not provided with the Sensor. It must be ordered separately as required.

Round Oil-resistant Connectors XS5 NEXT series

Appearance	Cable specification	Type	Cable diameter (mm)	Cable connection direction	Cable length (m)	Sensor I/O Connector model number	Applicable Proximity Sensor model number
M12 Smartclick Connector Models Straight type 	Oil-resistant PVC cable	Sockets on One Cable End	6 dia.	Straight	1	XS5F-D421-C80-X	E2E-X□□□-M1TJ(R) E2EQ-X□□□-M1TJ E2E(Q)-X□□□-M1
					2	XS5F-D421-D80-X	
					3	XS5F-D421-E80-X	
					5	XS5F-D421-G80-X	
					10	XS5F-D421-J80-X	
	Oil-resistant PVC robot cable	Sockets on One Cable End	6 dia.	Straight	1	XS5F-D421-C80-XR	
					2	XS5F-D421-D80-XR	
					3	XS5F-D421-E80-XR	
					5	XS5F-D421-G80-XR	
					10	XS5F-D421-J80-XR	
	Oil-resistant PVC cable	Socket and Plug on Cable Ends	6 dia.	Straight (Socket)/ Straight (Plug)	1	XS5W-D421-C81-X	
					2	XS5W-D421-D81-X	
					3	XS5W-D421-E81-X	
					5	XS5W-D421-G81-X	
					10	XS5W-D421-J81-X	
	Oil-resistant PVC robot cable	Socket and Plug on Cable Ends	6 dia.	Straight (Socket)/ Straight (Plug)	1	XS5W-D421-C81-XR	
					2	XS5W-D421-D81-XR	
					3	XS5W-D421-E81-XR	
5					XS5W-D421-G81-XR		
10					XS5W-D421-J81-XR		

Note: For details of the connector, refer to *XS5 NEXT Series* on page 87.

Round Water-resistant Connectors XS5 series

Appearance	Cable Specification	Type	Cable diameter (mm)	Cable Connection Direction	Cable length (m)	Sensor I/O Connector model number	Applicable Proximity Sensor model number	
M12 Smartclick Connector Straight type  Right-angle type 	PVC robot cable	Sockets on One Cable End	6 dia.	Straight	1	XS5F-D421-C80-F	E2E-X□□□-M1TJ(R) E2EQ-X□□□-M1TJ E2E(Q)-X□□□-M1	
					2	XS5F-D421-D80-F		
					3	XS5F-D421-E80-F		
					5	XS5F-D421-G80-F		
					10	XS5F-D421-J80-F		
				Right-angle	1	XS5F-D422-C80-F		
					2	XS5F-D422-D80-F		
					3	XS5F-D422-E80-F		
					5	XS5F-D422-G80-F		
					10	XS5F-D422-J80-F		
		Socket and Plug on Cable Ends	6 dia.		Straight (Socket)/ Straight (Plug)	1		XS5W-D421-C81-F
						2		XS5W-D421-D81-F
						3		XS5W-D421-E81-F
				5		XS5W-D421-G81-F		
				10		XS5W-D421-J81-F		
		Right-angle (Socket)/ Right-angle (Plug)	6 dia.	Right-angle (Socket)/ Right-angle (Plug)	2	XS5W-D422-D81-F		
					5	XS5W-D422-G81-F		
					Straight (Socket)/ Right-angle (Plug)	2		XS5W-D423-D81-F
5	XS5W-D423-G81-F							
Right-angle (Socket)/ Straight (Plug)	6 dia.				Right-angle (Socket)/ Straight (Plug)	2	XS5W-D424-D81-F	
		5	XS5W-D424-G81-F					

Note: For details of the connector, refer to *XS5 Series* on page 94.

E2E/E2EQ NEXT Series DC 3-wire

E2E/E2EQ NEXT Series DC 2-wire



XS5 NEXT Series

XS5

XS3

E2E/E2EQ NEXT Series

Round Water-resistant Connectors XS3 series

Appearance	Cable specification	Type	Cable diameter (mm)	No. of cable cores (Poles)	Cable connection direction	Cable length (m)	Sensor I/O Connector model number	Applicable Proximity Sensor model number
M8 Connector Straight type  Right-angle type 	PVC robot cable	Sockets on One Cable End	4 dia.	3	Straight	2	XS3F-M321-302-R	E2E-X□□□-M5
						5	XS3F-M321-305-R	
						10	XS3F-M321-310-R	
					Right-angle	2	XS3F-M322-302-R	
						5	XS3F-M322-305-R	
						10	XS3F-M322-310-R	
		Sockets and Plug on Cable Ends	4 dia.	4	Straight	2	XS3F-M421-402-R	E2E-X□□□-M3
						5	XS3F-M421-405-R	
						10	XS3F-M421-410-R	
					Right-angle	2	XS3F-M422-402-R	
						5	XS3F-M422-405-R	
						10	XS3F-M422-410-R	
Sockets and Plug on Cable Ends	4 dia.	3	Straight (Plug)/ Straight (Socket)	2	XS3W-M321-302-R	E2E-X□□□-M5		
				5	XS3W-M321-305-R			
				10	XS3W-M321-310-R			
			Straight (Plug)/ Straight (Socket)	2	XS3W-M421-402-R	E2E-X□□□-M3		
				5	XS3W-M421-405-R			
				10	XS3W-M421-410-R			

Note: For details of the connector, refer to *XS3 Series Datasheet* (No. G147).

Sensor I/O Connectors Oil resistance performance of mating combination

E2E NEXT Series		Applicable connector Model		
Connecting method	Model	XS5 NEXT Series	XS5 Series	XS3 Series
Pre-wired Connector Models	E2E-X□□-M1TJ(R)	Oil resistant (2 years) *	Water-resistant (IP67)	---
M12 Connector Models	E2E-X□□-M1	Water-resistant (IP67)	Water-resistant (IP67)	---
M8 Connector (4-pin) Models	E2E-X□□-M3	---	---	Water-resistant (IP67)
M8 Connector (3-pin) Models	E2E-X□□-M5	---	---	Water-resistant (IP67)

* Applicable cutting oil type: specified in JIS K 2241:2000

2 years of oil resistance indicates the median value of the product design and the oil-resistance performance criterion result (=Typical value). Products to be shipped will have around 2 years of oil resistance, but will very depending on the product.

e-jig (Mounting Sleeves) [Refer to Dimensions on page 66.]

A Mounting Bracket is not provided with the Sensor. It must be ordered separately as required.

Only applicable to standard body-sized E2E NEXT Series Sensors.

Appearance	Model	Applicable Sensors
	Y92E-J8S12	E2E NEXT M8 Shielded Sensors
	Y92E-J12S18	E2E NEXT M12 Shielded Sensors
	Y92E-J18S30	E2E NEXT M18 Shielded Sensors

Note: Not applicable for E2E NEXT Series long-body models and E2EQ NEXT Series (spatter-resistant) models.

Ratings and Specifications

PREMIUM Model

E2E NEXT Series (Quadruple/Triple distance model)
DC 3-wire
Shielded

Types Size Item Model	Quadruple distance model				Triple distance model				
	M8	M12	M18	M30	M8	M12	M18	M30	
	E2E-X4□8	E2E-X9□12	E2E-X14□18	E2E-X23□30	E2E-X3□8	E2E-X6□12	E2E-X12□18	E2E-X22□30	
Sensing distance	4 mm±10%	9 mm±10%	14 mm±10%	23 mm±10%	3 mm±10%	6 mm±10%	12 mm±10%	22 mm±10%	
Setting distance	0 to 3 mm	0 to 6.8 mm	0 to 10.6 mm	0 to 17.6 mm	0 to 2.4 mm	0 to 4.8 mm	0 to 9.6 mm	0 to 16.8 mm	
Differential travel	15% max. of sensing distance								
Detectable object	Ferrous metals (For non-ferrous metals, refer to the <i>Engineering Data</i> on page 48.)								
Standard sensing object	Iron, 12 × 12 × 1 mm	Iron, 27 × 27 × 1 mm	Iron, 42 × 42 × 1 mm	Iron, 69 × 69 × 1 mm	Iron, 9 × 9 × 1 mm	Iron, 18 × 18 × 1 mm	Iron, 36 × 36 × 1 mm	Iron, 66 × 66 × 1 mm	
Response frequency *1	700 Hz	700 Hz	350 Hz	200 Hz	1,000 Hz	800 Hz	500 Hz	200 Hz	
Power supply voltage	10 to 30 VDC (including 10% ripple (p-p)), Class 2								
Current consumption	1-output models: 16 mA max.					1-output models: 16 mA max., 2-output models: 20 mA max.			
Output configuration	B□ Models: PNP open collector, C□ Models: NPN open collector								
Operation mode (with sensing object approaching)	1-output models (B1, C1): NO (Normally open), 1-output models (B2, C2): NC (Normally closed)					1-output models (B1, C1): NO (Normally open), 1-output models (B2, C2): NC (Normally closed), 2-output models (B3, C3): NO+NC (Normally open, Normally closed)			
Control output	Load current	1-output models: 10 to 30 VDC, Class 2, 50 mA max.			1-output models: 10 to 30 VDC, Class 2, 100 mA max.	1-output models: 10 to 30 VDC, Class 2, 100 mA max., 2-output models: 10 to 30 VDC, Class 2, 50 mA max.			
	Residual voltage	1-output models: 2 V max. (Load current: 50 mA, Cable length: 2 m)			1-output models: 2 V max. (Load current: 100 mA, Cable length: 2 m)	1-output models: 2 V max. (Load current: 100 mA, Cable length: 2 m), 2-output models: 2 V max. (Load current: 50 mA, Cable length: 2 m)			
Indicator *2	In the Standard I/O mode (SIO mode): Operation indicator (orange, lit) and communication indicator (green, not lit) In the IO-Link communication mode (COM mode): Operation indicator (orange, lit) and communication indicator (green, blinking at 1 s intervals)								
Protection circuits	Power supply reverse polarity protection, Surge suppressor, Output short-circuit protection, Output reverse polarity protection								
Ambient temperature range	Operating: -25 to 60°C Storage: -25 to 70°C (with no icing or condensation)	Operating/Storage: -25 to 70°C (with no icing or condensation)							
Ambient humidity range	Operating/Storage: 35% to 95% (with no condensation)								
Temperature influence	-15% to 25% max. of sensing distance at 23°C in the temperature range of -25 to 60°C	±15% max. of sensing distance at 23°C in the temperature range of -25 to 70°C			±10% max. of sensing distance at 23°C in the temperature range of -25 to 70°C				
Voltage influence	±1% max. of sensing distance at rated voltage in the rated voltage ±15% range								
Insulation resistance	50 MΩ min. (at 500 VDC) between current-carrying parts and case								
Dielectric strength	1,000 VAC, 50/60 Hz for 1 minute between current-carrying parts and case								
Vibration resistance (destruction)	10 to 55 Hz, 1.5-mm double amplitude for 2 hours each in X, Y, and Z directions								
Shock resistance (destruction)	500 m/s ² 10 times each in X, Y, and Z directions	1,000 m/s ² 10 times each in X, Y, and Z directions			500 m/s ² 10 times each in X, Y, and Z directions	1,000 m/s ² 10 times each in X, Y, and Z directions			
Degree of protection	Pre-wired Models, Pre-wired Connector Models: IEC 60529: IP67, ISO 20653 (old standard: DIN 40050 PART9): IP69K, JIS C 0920 Annex 1: IP67G, Passed OMRON's Oil-resistant Component Evaluation Standards *3 (Cutting oil type: specified in JIS K 2241: 2000; Temperature: 35°C max.) Connector Models: IEC 60529: IP67, ISO 20653 (old standard: DIN 40050 PART9): IP69K								
Connection method	Pre-wired Models (Standard cable length: 2 m), Pre-wired Connector Models (Standard cable length: 0.3 m) and Connector Models (M12 Connector, M8 (4-pin) Connector and M8 (3-pin) Connector)								
Weight *4 (packed state)	Pre-wired	Approx. 85 g	Approx. 95 g	Approx. 180 g	Approx. 260 g	Approx. 85 g	Approx. 95 g	Approx. 180 g	Approx. 260 g
	M12 Pre-wired Smartclick Connector	Approx. 55 g	Approx. 70 g	Approx. 115 g	Approx. 200 g	Approx. 55 g	Approx. 70 g	Approx. 115 g	Approx. 200 g
	Connector	Approx. 40 g *5	Approx. 55 g	Approx. 95 g	Approx. 180 g	Approx. 40 g *5	Approx. 55 g	Approx. 95 g	Approx. 180 g

E2E/E2EQ NEXT Series

Item	Types Size	Quadruple distance model				Triple distance model			
		M8	M12	M18	M30	M8	M12	M18	M30
	Model	E2E-X4□8	E2E-X9□12	E2E-X14□18	E2E-X23□30	E2E-X3□8	E2E-X6□12	E2E-X12□18	E2E-X22□30
Materials	Case	Nickel-plated brass							
	Sensing surface	Polybutylene terephthalat (PBT)							
	Clamping nuts	Nickel-plated brass							
	Toothed washers	Zinc-plated iron							
	Cable	Vinyl chloride (PVC)							
Main IO-Link functions*2		Operation mode switching between NO and NC, self diagnosis enabling, excessive proximity judgment distance selecting, timer function of the control output and timer time selecting, instability output (IO-Link mode) ON delay timer time selecting function, monitor output, operating hours read-out, readout of the sensor internal temperature, and initial reset							
IO-Link Communication specifications*2	IO-Link specification	Ver 1.1							
	Baud rate	COM2 (38.4 kbps), COM3 (230.4 kbps)							
	Data length	PD size: 2 bytes, OD size: 1 byte (M-sequence type: TYPE_2_2)							
	Minimum cycle time	COM2: 2.3 ms, COM3: 0.4 ms							
Accessories		Instruction manual, Clamping nuts, Toothed washer							

*1. The response frequency is an average value. Measurement conditions are as follows: standard sensing object, a distance of twice the standard sensing object, and a set distance of half the sensing distance.

*2. IO-Link is not supported for NC-type PNP outputs or all types of NPN outputs.

*3. The Oil-resistant Component Evaluation Standards are OMRON's own durability evaluation standards.

2-year oil resistance indicates the median value of the product design and the oil-resistance performance criterion result (=Typical value).
The Pre-wired Connector Model verifies 2 years of oil resistance when mating with Round Oil-resistant Connectors XS5 NEXT series correctly.
The degree of protection is not satisfied with the part where cable wires are uncovered for the Pre-wired Models.

*4. Weight of the standard body-sized model.

*5. Both M8 connectors and M12 connectors are available.

PREMIUM Model

E2E NEXT Series (Quadruple/Triple distance model)
DC 3-wire
Unshielded

Item	Types Size Model	Quadruple distance model				Triple distance model			
		M8	M12	M18	M30	M8	M12	M18	M30
		E2E-X8M□8	E2E-X16M□12	E2E-X30M□18	E2E-X50M□30	E2E-X6M□8	E2E-X10M□12	E2E-X20M□18	E2E-X40M□30
Sensing distance		8 mm±10%	16 mm±10%	30 mm±10%	50 mm±10%	6 mm±10%	10 mm±10%	20 mm±10%	40 mm±10%
Setting distance		0 to 6 mm	0 to 12.2 mm	0 to 23 mm	0 to 38.2 mm	0 to 4.8 mm	0 to 8 mm	0 to 16 mm	0 to 32 mm
Differential travel		15% max. of sensing distance							
Detectable object		Ferrous metals (For non-ferrous metals, refer to the <i>Engineering Data</i> on page 48.)							
Standard sensing object		Iron, 24 x 24 x 1 mm	Iron, 48 x 48 x 1 mm	Iron, 90 x 90 x 1 mm	Iron, 150 x 150 x 1 mm	Iron, 18 x 18 x 1 mm	Iron, 30 x 30 x 1 mm	Iron, 60 x 60 x 1 mm	Iron, 120 x 120 x 1 mm
Response frequency *1		500 Hz	400 Hz	200 Hz	100 Hz	800 Hz	400 Hz	200 Hz	100 Hz
Power supply voltage		10 to 30 VDC (including 10% ripple (p-p)), Class 2							
Current consumption		1-output models: 16 mA max.				1-output models: 16 mA max., 2-output models: 20 mA max.			
Output configuration		B□ Models: PNP open collector C□ Models: NPN open collector							
Operation mode (with sensing object approaching)		1-output models (B1, C1): NO (Normally open), 1-output models (B2, C2): NC (Normally closed)				1-output models (B1, C1): NO (Normally open), 1-output models (B2, C2): NC (Normally closed), 2-output models (B3, C3): NO+NC (Normally open, Normally closed)			
Control output	Load current	1-output models: 10 to 30 VDC, Class 2, 50 mA max.				1-output models: 10 to 30 VDC, Class 2, 100 mA max.		1-output models: 10 to 30 VDC, Class 2, 100 mA max., 2-output models: 10 to 30 VDC, Class 2, 50 mA max.	
	Residual voltage	1-output models: 2 V max. (Load current: 50 mA, Cable length: 2 m)				1-output models: 2 V max. (Load current: 100 mA, Cable length: 2 m)		1-output models: 2 V max. (Load current: 100 mA, Cable length: 2 m), 2-output models: 2 V max. (Load current: 50 mA, Cable length: 2 m)	
Indicator *2		In the Standard I/O mode (SIO mode): Operation indicator (orange, lit) and communication indicator (green, not lit) In the IO-Link communication mode (COM mode): Operation indicator (orange, lit) and communication indicator (green, blinking at 1 s intervals)							
Protection circuits		Power supply reverse polarity protection, Surge suppressor, Output short-circuit protection, Output reverse polarity protection							
Ambient temperature range		Operating/Storage: -25 to 70°C (with no icing or condensation)							
Ambient humidity range		Operating/Storage: 35% to 95% (with no condensation)							
Temperature influence		±15% max. of sensing distance at 23°C in the temperature range of -25 to 70°C				±10% max. of sensing distance at 23°C in the temperature range of -25 to 70°C			
Voltage influence		±1% max. of sensing distance at rated voltage in the rated voltage ±15% range							
Insulation resistance		50 MΩ min. (at 500 VDC) between current-carrying parts and case							
Dielectric strength		1,000 VAC, 50/60 Hz for 1 minute between current-carrying parts and case							
Vibration resistance (destruction)		10 to 55 Hz, 1.5-mm double amplitude for 2 hours each in X, Y, and Z directions							
Shock resistance (destruction)		500 m/s ² 10 times each in X, Y, and Z directions	1,000 m/s ² 10 times each in X, Y, and Z directions			500 m/s ² 10 times each in X, Y, and Z directions	1,000 m/s ² 10 times each in X, Y, and Z directions		
Degree of protection		Pre-wired Models, Pre-wired Connector Models: IEC 60529:IP67, ISO 20653 (old standard: DIN 40050 PART9): IP69K, JIS C 0920 Annex 1: IP67G, Passed OMRON's Oil-resistant Component Evaluation Standards *3 (Cutting oil type: specified in JIS K 2241: 2000; Temperature: 35°C max.) Connector Models: IEC 60529: IP67, ISO 20653 (old standard: DIN 40050 PART9): IP69K							
Connection method		Pre-wired Models (Standard cable length: 2 m), Pre-wired Connector Models (Standard cable length: 0.3 m) and Connector Models (M12 Connector, M8 (4-pin) Connector and M8 (3-pin) Connector)							
Weight *4 (packed state)	Pre-wired	Approx. 85 g	Approx. 95 g	Approx. 190 g	Approx. 310 g	Approx. 85 g	Approx. 95 g	Approx. 190 g	Approx. 280 g
	M12 Pre-wired Smartclick Connector	Approx. 55 g	Approx. 70 g	Approx. 125 g	Approx. 250 g	Approx. 55 g	Approx. 70 g	Approx. 125 g	Approx. 220 g
	Connector	Approx. 40 g *5	Approx. 55 g	Approx. 105 g	Approx. 230 g	Approx. 40 g *5	Approx. 55 g	Approx. 105 g	Approx. 200 g

E2E/E2EQ NEXT Series

Types Size		Quadruple distance model				Triple distance model			
		M8	M12	M18	M30	M8	M12	M18	M30
Item	Model	E2E-X8M□8	E2E-X16M□12	E2E-X30M□18	E2E-X50M□30	E2E-X6M□8	E2E-X10M□12	E2E-X20M□18	E2E-X40M□30
Materials	Case	Stainless (SUS303)	Nickel-plated brass			Stainless (SUS303)	Nickel-plated brass		
	Sensing surface	Polybutylene terephthalat (PBT)							
	Clamping nuts	Nickel-plated brass							
	Toothed washers	Zinc-plated iron							
	Cable	Vinyl chloride (PVC)							
Main IO-Link functions*2		Operation mode switching between NO and NC, self diagnosis enabling, excessive proximity judgment distance selecting, timer function of the control output and timer time selecting, instability output (IO-Link mode) ON delay timer time selecting function, monitor output, operating hours read-out, readout of the sensor internal temperature, and initial reset							
IO-Link Communication specifications*2	IO-Link specification	Ver1.1							
	Baud rate	COM2 (38.4 kbps), COM3 (230.4 kbps)							
	Data length	PD size: 2 bytes, OD size: 1 byte (M-sequence type: TYPE_2_2)							
	Minimum cycle time	COM2: 2.3 ms, COM3: 0.4 ms							
Accessories		Instruction manual, Clamping nuts, Toothed washer							

*1. The response frequency is an average value. Measurement conditions are as follows: standard sensing object, a distance of twice the standard sensing object, and a set distance of half the sensing distance.

*2. IO-Link is not supported for NC-type PNP outputs or all types of NPN outputs.

*3. The Oil-resistant Component Evaluation Standards are OMRON's own durability evaluation standards. 2-year oil resistance indicates the median value of the product design and the oil-resistance performance criterion result (=Typical value). Actual performance can be expected to decline after two years on average from shipment. The Pre-wired Connector Model verifies 2 years of oil resistance when mating with Round Oil-resistant Connectors XS5 NEXT series correctly. The degree of protection is not satisfied with the part where cable wires are uncovered for the Pre-wired Models.

*4. Weight of the standard body-sized model.

*5. Both M8 connectors and M12 connectors are available.

PREMIUM Model

E2EQ NEXT Series (Spatter-resistant Triple distance model)
DC 3-wire
Shielded

Item	Types Size Model	Triple distance Models			
		M8	M12	M18	M30
		E2EQ-X3□8	E2EQ-X6□12	E2EQ-X12□18	E2EQ-X22□30
Sensing distance		3 mm±10%	6 mm±10%	12 mm±10%	22 mm±10%
Setting distance		0 to 2.4 mm	0 to 4.8 mm	0 to 9.6 mm	0 to 16.8 mm
Differential travel		15% max. of sensing distance			
Detectable object		Ferrous metals (For non-ferrous metals, refer to the <i>Engineering Data</i> on page 48.)			
Standard sensing object		Iron, 9 × 9 × 1 mm	Iron, 18 × 18 × 1 mm	Iron, 36 × 36 × 1 mm	Iron, 66 × 66 × 1 mm
Response frequency *1		1,000 Hz	800 Hz	500 Hz	200 Hz
Power supply voltage		10 to 30 VDC (including 10% ripple (p-p)), Class 2			
Current consumption		1-output models: 16 mA max.	1-output models: 16 mA max. 2-output models: 20 mA max.		
Output configuration		B□ Models: PNP open collector, C□ Models: NPN open collector			
Operation mode (with sensing object approaching)		1-output models (B1, C1): NO (Normally open), 1-output models (B2, C2): NC (Normally closed)	1-output models (B1, C1): NO (Normally open), 1-output models (B2, C2): NC (Normally closed), 2-output models (B3, C3): NO+NC (Normally open, Normally closed)		
Control output	Load current	1-output models: 10 to 30 VDC, Class 2, 100 mA max.	1-output models: 10 to 30 VDC, Class 2, 100 mA max., 2-output models: 10 to 30 VDC, Class 2, 50 mA max.		
	Residual voltage	1-output models: 2 V max. (Load current: 100 mA, Cable length: 2 m)	1-output models: 2 V max. (Load current: 100 mA, Cable length: 2 m), 2-output models: 2 V max. (Load current: 50 mA, Cable length: 2 m)		
Indicator *2		In the Standard I/O mode (SIO mode): Operation indicator (orange, lit) and communication indicator (green, not lit) In the IO-Link communication mode (COM mode): Operation indicator (orange, lit) and communication indicator (green, blinking at 1 s intervals)			
Protection circuits		Power supply reverse polarity protection, Surge suppressor, Output short-circuit protection, Output reverse polarity protection			
Ambient temperature range		Operating/Storage: -25 to 70°C (with no icing or condensation)			
Ambient humidity range		Operating/Storage: 35% to 95% (with no condensation)			
Temperature influence		±10% max. of sensing distance at 23°C in the temperature range of -25 to 70°C			
Voltage influence		±1% max. of sensing distance at rated voltage in the rated voltage ±15% range			
Insulation resistance		50 MΩ min. (at 500 VDC) between current-carrying parts and case			
Dielectric strength		1,000 VAC, 50/60 Hz for 1 minute between current-carrying parts and case			
Vibration resistance (destruction)		10 to 55 Hz, 1.5-mm double amplitude for 2 hours each in X, Y, and Z directions			
Shock resistance (destruction)		500 m/s ² 10 times each in X, Y, and Z directions	1,000 m/s ² 10 times each in X, Y, and Z directions		
Degree of protection		Pre-wired Models, Pre-wired Connector Models: IEC 60529: IP67, JIS C 0920 Annex 1: IP67G Connector Models: IEC 60529: IP67			
Connection method		Pre-wired Models (Standard cable length: 2 m) and Pre-wired Connector Models (Standard cable length: 0.3 m), M12 Connector Models			
Weight *3 (packed state)	Pre-wired Models	Approx. 85 g	Approx. 95 g	Approx. 180 g	Approx. 260 g
	M12 Pre-wired Smartclick Connector	Approx. 55 g	Approx. 70 g	Approx. 115 g	Approx. 200 g
	Connector	Approx. 40 g	Approx. 55 g	Approx. 95 g	Approx. 180 g
Materials	Case	Fluororesin coating (Base material: brass)			
	Sensing surface	Fluorine resin			
	Clamping nuts	Fluororesin coating (Base material: brass)			
	Toothed washers	Zinc-plated iron			
	Cable	Vinyl chloride (PVC)			
Main IO-Link functions *2		Operation mode switching between NO and NC, self diagnosis enabling, excessive proximity judgment distance selecting, timer function of the control output and timer time selecting, instability output (IO-Link mode) ON delay timer time selecting function, monitor output, operating hours read-out, readout of the sensor internal temperature, and initial reset			
IO-Link Communication specifications *2	IO-Link specification	Ver 1.1			
	Baud rate	COM2 (38.4 kbps), COM3 (230.4 kbps)			
	Data length	PD size: 2 bytes, OD size: 1 byte (M-sequence type: TYPE_2_2)			
	Minimum cycle time	COM2: 2.3 ms, COM3: 0.4 ms			
Accessories		Instruction manual, Clamping nuts, Toothed washer			

*1. The response frequency is an average value. Measurement conditions are as follows: standard sensing object, a distance of twice the standard sensing object, and a set distance of half the sensing distance.

*2. IO-Link is not supported for NC-type PNP outputs or all types of NPN outputs.

*3. Weight of the standard body-sized model.

E2E/E2EQ NEXT Series

BASIC Model

E2E NEXT Series (Double/Single distance model)

DC 3-wire

Shielded

Item	Types Size Model	Double distance				Single distance			
		M8	M12	M18	M30	M8	M12	M18	M30
		E2E-X2□8	E2E-X4□12	E2E-X8□18	E2E-X15□30	E2E-X1R5□8	E2E-X2□12	E2E-X5□18	E2E-X10□30
Sensing distance		2 mm±10%	4 mm±10%	8 mm±10%	15 mm±10%	1.5 mm±10%	2 mm±10%	5 mm±10%	10 mm±10%
Setting distance		0 to 1.6 mm	0 to 3.2 mm	0 to 6.4 mm	0 to 12 mm	0 to 1.2 mm	0 to 1.6 mm	0 to 4 mm	0 to 8 mm
Differential travel		15% max. of sensing distance				10% max. of sensing distance			
Detectable object		Ferrous metals (For non-ferrous metals, refer to the <i>Engineering Data</i> on page 48.)							
Standard sensing object		Iron, 8 × 8 × 1 mm	Iron, 12 × 12 × 1 mm	Iron, 24 × 24 × 1 mm	Iron, 45 × 45 × 1 mm	Iron, 8 × 8 × 1 mm	Iron, 12 × 12 × 1 mm	Iron, 18 × 18 × 1 mm	Iron, 30 × 30 × 1 mm
Response frequency *1		1,500 Hz	1,000 Hz	500 Hz	250 Hz	2,000 Hz	1,500 Hz	600 Hz	400 Hz
Power supply voltage		10 to 30 VDC (including 10% ripple (p-p)), Class 2							
Current consumption		1-output models: 16 mA max. 2-output models: 20 mA max.							
Output configuration		B□ Models: PNP open collector C□ Models: NPN open collector							
Operation mode (with sensing object approaching)		1-output models (B1, C1): NO (Normally open), 1-output models (B2, C2): NC (Normally closed), 2-output models (B3, C3): NO+NC (Normally open, Normally closed) *3							
Control output	Load current	1-output models: 10 to 30 VDC, Class 2, 200 mA max., (-40 to 70°C), 100 mA max., (70 to 85°C) 2-output models: 10 to 30 VDC, Class 2, 50 mA max.	1-output models: 10 to 30 VDC, Class 2, 200 mA max., 2-output models: 10 to 30 VDC, Class 2, 100 mA max.			1-output models: 10 to 30 VDC, Class 2, 200 mA max., (-40 to 70°C), 100 mA max., (70 to 85°C) 2-output models: 10 to 30 VDC, Class 2, 50 mA max.	1-output models: 10 to 30 VDC, Class 2, 200 mA max., 2-output models: 10 to 30 VDC, Class 2, 100 mA max.		
	Residual voltage	1-output models: 2 V max. (Load current: 200 mA, Cable length: 2 m), 2-output models: 2 V max. (Load current: 50 mA, Cable length: 2 m)	1-output models: 2 V max. (Load current: 200 mA, Cable length: 2 m), 2-output models: 2 V max. (Load current: 100 mA, Cable length: 2 m)			1-output models: 2 V max. (Load current: 200 mA, Cable length: 2 m), 2-output models: 2 V max. (Load current: 50 mA, Cable length: 2 m)	1-output models: 2 V max. (Load current: 200 mA, Cable length: 2 m), 2-output models: 2 V max. (Load current: 100 mA, Cable length: 2 m)		
Indicator *2		In the Standard I/O mode (SIO mode): Operation indicator (orange, lit) and communication indicator (green, not lit) In the IO-Link communication mode (COM mode): Operation indicator (orange, lit) and communication indicator (green, blinking at 1 s intervals)							
Protection circuits		Power supply reverse polarity protection, Surge suppressor, Output short-circuit protection, Output reverse polarity protection							
Ambient temperature range		Operating/Storage: -40 to 85°C (with no icing or condensation) Note: The UL temperature rating for M12 Pre-wired Connector Models is -25 to 70°C.							
Ambient humidity range		Operating/Storage: 35% to 95% (with no condensation)							
Temperature influence		±15% max. of sensing distance at 23°C in the temperature range of -40 to 85°C ±10% max. of sensing distance at 23°C in the temperature range of -25 to 70°C							
Voltage influence		±1% max. of sensing distance at rated voltage in the rated voltage ±15% range							
Insulation resistance		50 MΩ min. (at 500 VDC) between current-carrying parts and case							
Dielectric strength		1,000 VAC, 50/60 Hz for 1 minute between current-carrying parts and case							
Vibration resistance (destruction)		10 to 55 Hz, 1.5-mm double amplitude for 2 hours each in X, Y, and Z directions							
Shock resistance (destruction)		500 m/s ² 10 times each in X, Y, and Z directions	1,000 m/s ² 10 times each in X, Y, and Z directions			500 m/s ² 10 times each in X, Y, and Z directions	1,000 m/s ² 10 times each in X, Y, and Z directions		
Degree of protection		Pre-wired Models, Pre-wired Connector Models: IEC 60529:IP67, ISO 20653 (old standard: DIN 40050 PART9): IP69K, JIS C 0920 Annex 1: IP67G, Passed OMRON's Oil-resistant Component Evaluation Standards *4 (Cutting oil type: specified in JIS K 2241:2000; Temperature: 35°C max.) Connector Models: IEC 60529: IP67, ISO 20653 (old standard: DIN 40050 PART9): IP69K							
Connection method		Pre-wired Models (Standard cable length: 2 m), Pre-wired Connector Models (Standard cable length: 0.3 m) and Connector Models (M12 Connector, M8 (4-pin) Connector and M8 (3-pin) Connector)							
Weight *5 (packed state)	Pre-wired	Approx. 85 g	Approx. 95 g	Approx. 170 g	Approx. 240 g	Approx. 85 g	Approx. 95 g	Approx. 170 g	Approx. 240 g
	M12 Pre-wired Smartclick Connector	Approx. 55 g	Approx. 70 g	Approx. 105 g	Approx. 170 g	Approx. 55 g	Approx. 70 g	Approx. 105 g	Approx. 170 g
	Connector	Approx. 40 g *6	Approx. 55 g	Approx. 85 g	Approx. 160 g	Approx. 40 g *6	Approx. 55 g	Approx. 85 g	Approx. 160 g

Item	Types Size Model	Double distance				Single distance			
		M8	M12	M18	M30	M8	M12	M18	M30
		E2E-X2□8	E2E-X4□12	E2E-X8□18	E2E-X15□30	E2E-X1R5□8	E2E-X2□12	E2E-X5□18	E2E-X10□30
Materials	Case	Stainless (SUS303)	Nickel-plated brass			Stainless (SUS303)	Nickel-plated brass		
	Sensing surface	Polybutylene terephthalat (PBT)							
	Clamping nuts	Nickel-plated brass							
	Toothed washers	Zinc-plated iron							
	Cable	Vinyl chloride (PVC)							
Main IO-Link functions *2		Operation mode switching between NO and NC, self diagnosis enabling, excessive proximity judgment distance selecting, timer function of the control output and timer time selecting, instability output (IO-Link mode) ON delay timer time selecting function, monitor output, operating hours read-out, readout of the sensor internal temperature, and initial reset							
IO-Link Communication specifications *2	IO-Link specification	Ver1.1							
	Baud rate	COM2 (38.4 kbps), COM3 (230.4 kbps)							
	Data length	PD size: 2 bytes, OD size: 1 byte (M-sequence type: TYPE_2_2)							
	Minimum cycle time	COM2: 2.3 ms, COM3: 0.4 ms							
Accessories		Instruction manual, Clamping nuts, Toothed washer							

- *1. The response frequency is an average value. Measurement conditions are as follows: standard sensing object, a distance of twice the standard sensing object, and a set distance of half the sensing distance.
- *2. IO-Link is not supported for NC-type PNP outputs or all types of NPN outputs.
- *3. Dual-output specification for the M8-size models is only applicable to long-size M12 Connector models.
- *4. The Oil-resistant Component Evaluation Standards are OMRON's own durability evaluation standards. 2-year oil resistance indicates the median value of the product design and the oil-resistance performance criterion result (=Typical value). Actual performance can be expected to decline after two years on average from shipment. The Pre-wired Connector Model verifies 2 years of oil resistance when mating with Round Oil-resistant Connectors XS5 NEXT series correctly. The degree of protection is not satisfied with the part where cable wires are uncovered for the Pre-wired Models.
- *5. Weight of the standard body-sized model.
- *6. Both M8 connectors and M12 connectors are available.

E2E/E2EQ NEXT Series DC-3-wire

E2E/E2EQ NEXT Series DC-2-wire

XS5 NEXT Series

XS5

XS3

E2E/E2EQ NEXT Series

BASIC Model

E2E NEXT Series (Double/Single distance model)

DC 3-wire

Unshielded

Item	Types Size Model	Double distance model				Single distance model			
		M8	M12	M18	M30	M8	M12	M18	M30
		E2E-X4M□8	E2E-X8M□12	E2E-X16M□18	E2E-X30M□30	E2E-X2M□8	E2E-X5M□12	E2E-X10M□18	E2E-X18M□30
Sensing distance		4 mm±10%	8 mm±10%	16 mm±10%	30 mm±10%	2 mm±10%	5 mm±10%	10 mm±10%	18 mm±10%
Setting distance		0 to 3.2 mm	0 to 6.4 mm	0 to 12.8 mm	0 to 24 mm	0 to 1.6 mm	0 to 4 mm	0 to 8 mm	0 to 14.4 mm
Differential travel		15% max. of sensing distance				10% max. of sensing distance			
Detectable object		Ferrous metals (For non-ferrous metals, refer to the <i>Engineering Data</i> on page 48.)							
Standard sensing object		Iron, 12 × 12 × 1 mm	Iron, 24 × 24 × 1 mm	Iron, 48 × 48 × 1 mm	Iron, 90 × 90 × 1 mm	Iron, 8 × 8 × 1 mm	Iron, 15 × 15 × 1 mm	Iron, 30 × 30 × 1 mm	Iron, 54 × 54 × 1 mm
Response frequency *1		1,000 Hz	800 Hz	400 Hz	100 Hz	1,000 Hz	800 Hz	400 Hz	100 Hz
Power supply voltage		10 to 30 VDC (including 10% ripple (p-p)), Class 2							
Current consumption		1-output models: 16 mA max. 2-output models: 20 mA max.							
Output configuration		B□ Models: PNP open collector C□ Models: NPN open collector							
Operation mode (with sensing object approaching)		1-output models (B1, C1): NO (Normally open), 1-output models (B2, C3): NC (Normally closed) 2-output models (B3, C3): NO+NC (Normally open, Normally closed) *3							
Control output	Load current	1-output models: 10 to 30 VDC, Class 2, 200 mA max., (-40 to 70°C), 100 mA max., (70 to 85°C) 2-output models: 10 to 30 VDC, Class 2, 50 mA max.	1-output models: 10 to 30 VDC, Class 2, 200 mA max., 2-output models: 10 to 30 VDC, Class 2, 100 mA max.			1-output models: 10 to 30 VDC, Class 2, 200 mA max., (-40 to 70°C), 100 mA max., (70 to 85°C) 2-output models: 10 to 30 VDC, Class 2, 50 mA max.	1-output models: 10 to 30 VDC, Class 2, 200 mA max., 2-output models: 10 to 30 VDC, Class 2, 100 mA max.		
	Residual voltage	1-output models: 2 V max. (Load current: 200 mA, Cable length: 2 m), 2-output models: 2 V max. (Load current: 50 mA, Cable length: 2 m)	1-output models: 2 V max. (Load current: 200 mA, Cable length: 2 m), 2-output models: 2 V max. (Load current: 100 mA, Cable length: 2 m)			1-output models: 2 V max. (Load current: 200 mA, Cable length: 2 m), 2-output models: 2 V max. (Load current: 50 mA, Cable length: 2 m)	1-output models: 2 V max. (under load current of 200 mA with cable length of 2 m), 2-output models: 2 V max. (under load current of 100 mA with cable length of 2 m)		
Indicator *2		In the Standard I/O mode (SIO mode): Operation indicator (orange, lit) and communication indicator (green, not lit) In the IO-Link communication mode (COM mode): Operation indicator (orange, lit) and communication indicator (green, blinking at 1 s intervals)							
Protection circuits		Power supply reverse polarity protection, Surge suppressor, Output short-circuit protection, Output reverse polarity protection							
Ambient temperature range		Operating/Storage: -40 to 85°C (with no icing or condensation) Note: The UL temperature rating for M12 Pre-wired Connector Models is -25 to 70°C.							
Ambient humidity range		Operating/Storage: 35% to 95% (with no condensation)							
Temperature influence		±15% max. of sensing distance at 23°C in the temperature range of -40 to 85°C ±10% max. of sensing distance at 23°C in the temperature range of -25 to 70°C							
Voltage influence		±1% max. of sensing distance at rated voltage in the rated voltage ±15% range							
Insulation resistance		50 MΩ min. (at 500 VDC) between current-carrying parts and case							
Dielectric strength		1,000 VAC, 50/60 Hz for 1 minute between current-carrying parts and case							
Vibration resistance (destruction)		10 to 55 Hz, 1.5-mm double amplitude for 2 hours each in X, Y, and Z directions							
Shock resistance (destruction)		500 m/s ² 10 times each in X, Y, and Z directions	1,000 m/s ² 10 times each in X, Y, and Z directions			500 m/s ² 10 times each in X, Y, and Z directions	1,000 m/s ² 10 times each in X, Y, and Z directions		
Degree of protection		Pre-wired Models, Pre-wired Connector Models: IEC 60529:IP67, ISO 20653 (old standard: DIN 40050 PART9): IP69K, JIS C 0920 Annex 1: IP67G, Passed OMRON's Oil-resistant Component Evaluation Standards *4 (Cutting oil type: specified in JIS K 2241:2000; Temperature: 35°C max.) Connector Models: IEC 60529:IP67, ISO 20653 (old standard: DIN 40050 PART9): IP69K							
Connection method		Pre-wired Models (Standard cable length: 2 m), Pre-wired Connector Models (Standard cable length: 0.3 m) and Models (M12 Connector, M8 (4-pin) Connector and M8 (3-pin) Connector)							
Weight *5 (packed state)	Pre-wired	Approx. 85 g	Approx. 95 g	Approx. 170 g	Approx. 280 g	Approx. 85 g	Approx. 95 g	Approx. 170 g	Approx. 240 g
	M12 Pre-wired Smartclick Connector	Approx. 55 g	Approx. 70 g	Approx. 105 g	Approx. 220 g	Approx. 55 g	Approx. 70 g	Approx. 105 g	Approx. 170 g
	Connector	Approx. 40 g *6	Approx. 55 g	Approx. 85 g	Approx. 200 g	Approx. 40 g *6	Approx. 55 g	Approx. 85 g	Approx. 160 g

Item	Types Size Model	Double distance model				Single distance model			
		M8	M12	M18	M30	M8	M12	M18	M30
		E2E-X4M□8	E2E-X8M□12	E2E-X16M□18	E2E-X30M□30	E2E-X2M□8	E2E-X5M□12	E2E-X10M□18	E2E-X18M□30
Materials	Case	Stainless (SUS303)	Nickel-plated brass			Stainless (SUS303)	Nickel-plated brass		
	Sensing surface	Polybutylene terephthalat (PBT)							
	Clamping nuts	Nickel-plated brass							
	Toothed washers	Zinc-plated iron							
	Cable	Vinyl chloride (PVC)							
Main IO-Link functions *2		Operation mode switching between NO and NC, self diagnosis enabling, excessive proximity judgment distance selecting, timer function of the control output and timer time selecting, instability output (IO-Link mode) ON delay timer time selecting function, monitor output, operating hours read-out, readout of the sensor internal temperature, and initial reset							
IO-Link Communication specifications *2	IO-Link specification	Ver 1.1							
	Baud rate	COM2 (38.4 kbps), COM3 (230.4 kbps)							
	Data length	PD size: 2 bytes, OD size: 1 byte (M-sequence type: TYPE_2_2)							
	Minimum cycle time	COM2: 2.3 ms, COM3: 0.4 ms							
Accessories		Instruction manual, Clamping nuts, Toothed washer							

- *1. The response frequency is an average value. Measurement conditions are as follows: standard sensing object, a distance of twice the standard sensing object, and a set distance of half the sensing distance.
- *2. IO-Link is not supported for NC-type PNP outputs or all types of NPN outputs.
- *3. Dual-output specification for the M8-size models is only applicable to long-size M12 Connector models.
- *4. The Oil-resistant Component Evaluation Standards are OMRON's own durability evaluation standards. 2-year oil resistance indicates the median value of the product design and the oil-resistance performance criterion result (=Typical value). Actual performance can be expected to decline after two years on average from shipment. The Pre-wired Connector Model verifies 2 years of oil resistance when mating with Round Oil-resistant Connectors XS5 NEXT series correctly. The degree of protection is not satisfied with the part where cable wires are uncovered for the Pre-wired Models.
- *5. Weight of the standard body-sized model.
- *6. Both M8 connectors and M12 connectors are available.

E2E/E2EQ NEXT Series

BASIC Model

E2E Q NEXT Series (Spatter-resistant Double distance/Single distance model)

DC 3-Wire Models

Shielded

Item	Types Size Model	Double distance				Single distance			
		M8	M12	M18	M30	M8	M12	M18	M30
		E2EQ-X2□8	E2EQ-X4□12	E2EQ-X8□18	E2EQ-X15□30	E2EQ-X1R5□8	E2EQ-X2□12	E2EQ-X5□18	E2EQ-X10□30
Sensing distance		2 mm±10%	4 mm±10%	8 mm±10%	15 mm±10%	1.5 mm±10%	2 mm±10%	5 mm±10%	10 mm±10%
Setting distance		0 to 1.6 mm	0 to 3.2 mm	0 to 6.4 mm	0 to 12 mm	0 to 1.2 mm	0 to 1.6 mm	0 to 4 mm	0 to 8 mm
Differential travel		15% max. of sensing distance				10% max. of sensing distance			
Detectable object		Ferrous metals (For non-ferrous metals, refer to the <i>Engineering Data</i> on page 48.)							
Standard sensing object		Iron, 8 × 8 × 1 mm	Iron, 12 × 12 × 1 mm	Iron, 24 × 24 × 1 mm	Iron, 45 × 45 × 1 mm	Iron, 8 × 8 × 1 mm	Iron, 12 × 12 × 1 mm	Iron, 18 × 18 × 1 mm	Iron, 30 × 30 × 1 mm
Response frequency *1		1,500 Hz	1,000 Hz	500 Hz	250 Hz	2,000 Hz	1,500 Hz	600 Hz	400 Hz
Power supply voltage		10 to 30 VDC (including 10% ripple (p-p)), Class 2							
Current consumption		1-output models: 16 mA max. 2-output models: 20 mA max.							
Output configuration		B□ Models: PNP open collector, C□ Models: NPN open collector							
Operation mode (with sensing object approaching)		1-output models (B1, C1): NO (Normally open), 1-output models (B2, C2): NC (Normally closed) 2-output models (B3, C3): NO+NC (Normally open, Normally closed)							
Control output	Load current	1-output models: 10 to 30 VDC, Class 2, 200 mA max., (-40 to 70°C), 100 mA max., (70 to 85°C) 2-output models: 10 to 30 VDC, Class 2, 50 mA max.	1-output models: 10 to 30 VDC, Class 2, 200 mA max., 2-output models: 10 to 30 VDC, Class 2, 100 mA max.			1-output models: 10 to 30 VDC, Class 2, 200 mA max., (-40 to 70°C), 100 mA max., (70 to 85°C) 2-output models: 10 to 30 VDC, Class 2, 50 mA max.	1-output models: 10 to 30 VDC, Class 2, 200 mA max., 2-output models: 10 to 30 VDC, Class 2, 100 mA max.		
	Residual voltage	1-output models: 2 V max. (Load current: 200 mA, Cable length: 2 m), 2-output models: 2 V max. (Load current: 50 mA, Cable length: 2 m)	1-output models: 2 V max. (Load current: 200 mA, Cable length: 2 m), 2-output models: 2 V max. (Load current: 100 mA, Cable length: 2 m)			1-output models: 2 V max. (Load current: 200 mA, Cable length: 2 m), 2-output models: 2 V max. (Load current: 50 mA, Cable length: 2 m)	1-output models: 2 V max. (Load current: 200 mA, Cable length: 2 m), 2-output models: 2 V max. (Load current: 100 mA, Cable length: 2 m)		
Indicator *2		In the Standard I/O mode (SIO mode): Operation indicator (orange, lit) and communication indicator (green, not lit) In the IO-Link communication mode (COM mode): Operation indicator (orange, lit) and communication indicator (green, blinking at 1 s intervals)							
Protection circuits		Power supply reverse polarity protection, Surge suppressor, Output short-circuit protection, Output reverse polarity protection							
Ambient temperature range		Operating/Storage: -40 to 85°C (with no icing or condensation) Note: The UL temperature rating for M12 Pre-wired Connector Models is -25 to 70°C.							
Ambient humidity range		Operating/Storage: 35% to 95% (with no condensation)							
Temperature influence		±15% max. of sensing distance at 23°C in the temperature range of -40 to 85°C ±10% max. of sensing distance at 23°C in the temperature range of -25 to 70°C							
Voltage influence		±1% max. of sensing distance at rated voltage in the rated voltage ±15% range							
Insulation resistance		50 MΩ min. (at 500 VDC) between current-carrying parts and case							
Dielectric strength		1,000 VAC, 50/60 Hz for 1 minute between current-carrying parts and case							
Vibration resistance (destruction)		10 to 55 Hz, 1.5-mm double amplitude for 2 hours each in X, Y, and Z directions							
Shock resistance (destruction)		500 m/s ² 10 times each in X, Y, and Z directions	1,000 m/s ² 10 times each in X, Y, and Z directions			500 m/s ² 10 times each in X, Y, and Z directions	1,000 m/s ² 10 times each in X, Y, and Z directions		
Degree of protection		Pre-wired Models, Pre-wired Connector Models: IEC 60529:IP67, JIS C 0920 Annex 1: IP67G Connector Models: IEC 60529 IP67							
Connection method		Pre-wired Models (Standard cable length: 2 m) and Pre-wired Connector Models (Standard cable length: 0.3 m), M12 Connector Models							
Weight *3 (packed state)	Pre-wired	Approx. 85 g	Approx. 95 g	Approx. 170 g	Approx. 240 g	Approx. 85 g	Approx. 95 g	Approx. 170 g	Approx. 240 g
	M12 Pre-wired Smartclick Connector	Approx. 55 g	Approx. 70 g	Approx. 105 g	Approx. 170 g	Approx. 55 g	Approx. 70 g	Approx. 105 g	Approx. 170 g
	Connector	Approx. 40 g	Approx. 55 g	Approx. 85 g	Approx. 160 g	Approx. 40 g	Approx. 55 g	Approx. 85 g	Approx. 160 g

Item	Types Size Model	Double distance				Single distance			
		M8	M12	M18	M30	M8	M12	M18	M30
		E2EQ-X2□8	E2EQ-X4□12	E2EQ-X8□18	E2EQ-X15□30	E2EQ-X1R5□8	E2EQ-X2□12	E2EQ-X5□18	E2EQ-X10□30
Materials	Case	Fluororesin coating (Base material: SUS303)	Fluororesin coating (Base material: brass)		Fluororesin coating (Base material: SUS303)	Fluororesin coating (Base material: brass)			
	Sensing surface	Fluorine resin							
	Clamping nuts	Fluororesin coating (Base material: brass)							
	Toothed washers	Zinc-plated iron							
	Cable	Vinyl chloride (PVC)							
Main IO-Link functions *2		Operation mode switching between NO and NC, self diagnosis enabling, excessive proximity judgment distance selecting, timer function of the control output and timer time selecting, instability output (IO-Link mode) ON delay timer time selecting function, monitor output, operating hours read-out, readout of the sensor internal temperature, and initial reset							
IO-Link Communication specifications *2	IO-Link specification	Ver1.1							
	Baud rate	COM2 (38.4 kbps), COM3 (230.4 kbps)							
	Data length	PD size: 2 bytes, OD size: 1 byte (M-sequence type: TYPE_2_2)							
	Minimum cycle time	COM2: 2.3 ms, COM3: 0.4 ms							
Accessories		Instruction manual, Clamping nuts, Toothed washer							

*1. The response frequency is an average value. Measurement conditions are as follows: standard sensing object, a distance of twice the standard sensing object, and a set distance of half the sensing distance.

*2. IO-Link is not supported for NC-type PNP outputs or all types of NPN outputs.

*3. Weight of the standard body-sized model.

E2E/E2EQ NEXT Series

Engineering Data (Reference Value)

Sensing Area

PREMIUM Model

Quadruple distance model

Shielded

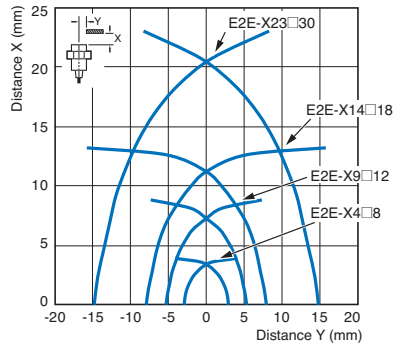

Unshielded

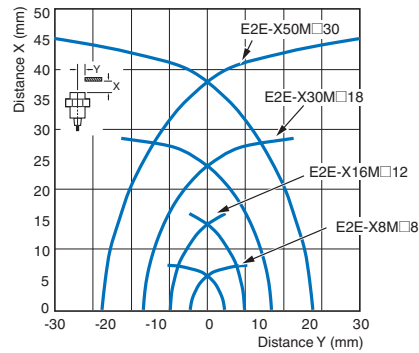

Triple distance model, Spatter-resistant Triple distance model

Shielded

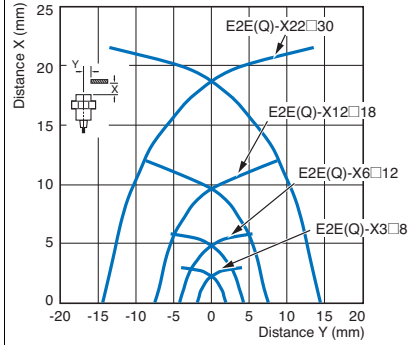

Unshielded

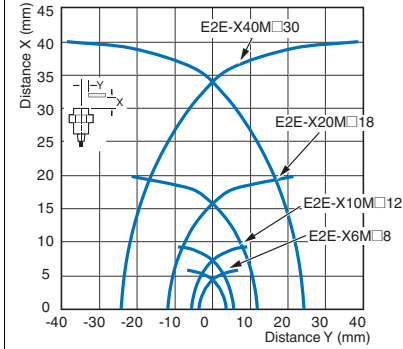

BASIC Model

Double distance model, Spatter-resistant Double distance model

Shielded

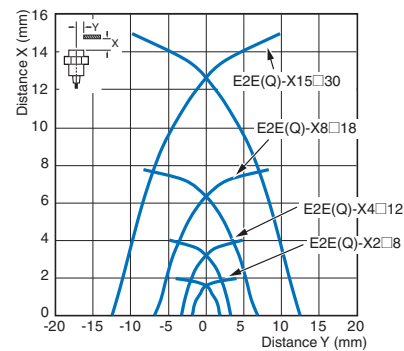

Unshielded

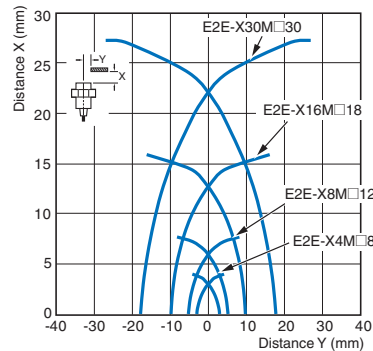

Single distance model, Spatter-resistant Single distance model

Shielded

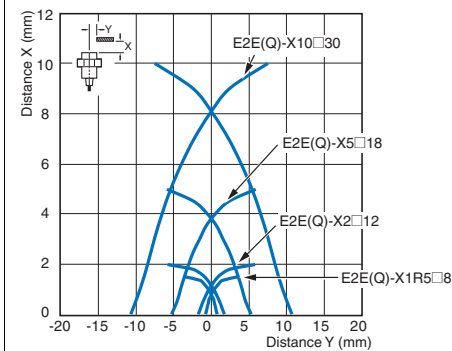

Unshielded

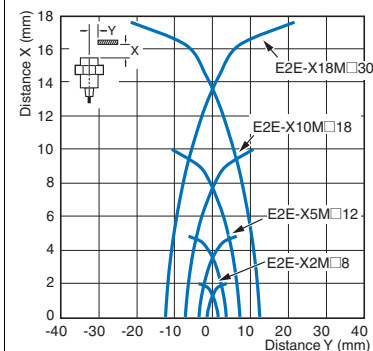

Influence of Sensing Object Size and Material

PREMIUM Model

Shielded

Quadruple distance model

Size: M8 E2E-X4□8

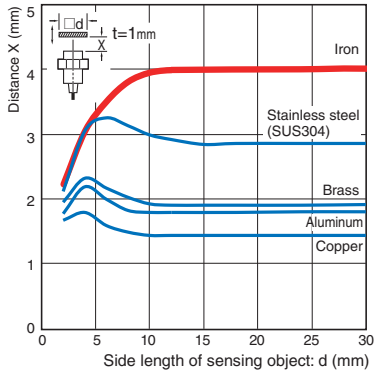

Size: M12 E2E-X9□12

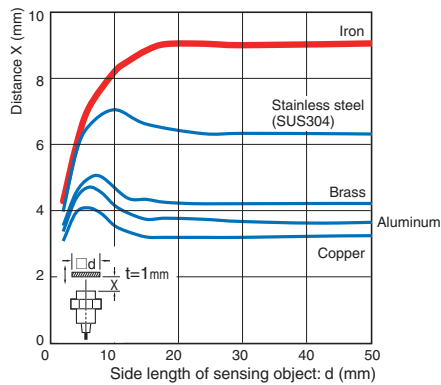

Size: M18 E2E-X14□18

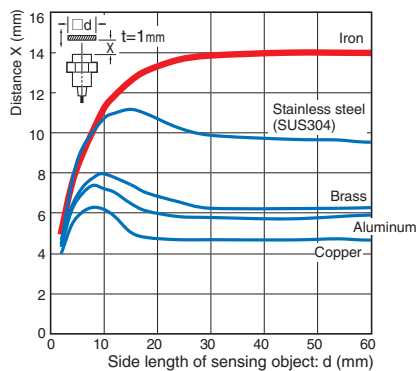

Size: M30 E2E-X23□30

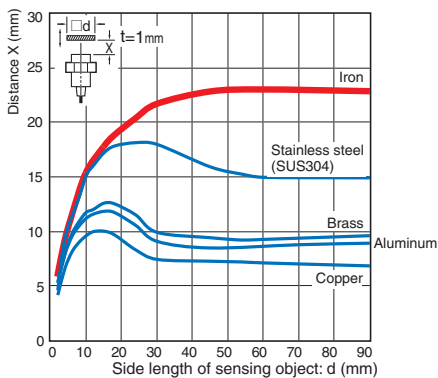

Triple distance model, Spatter-resistant Triple distance model

Size: M8 E2E(Q)-X3□8

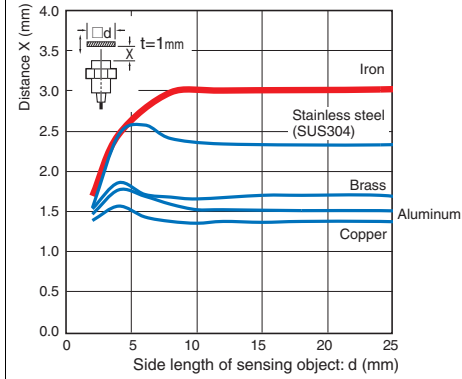

Size: M12 E2E(Q)-X6□12

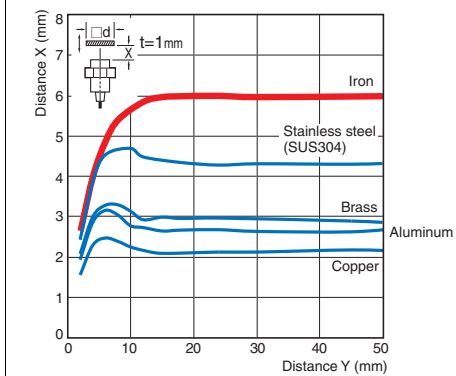

Size: M18 E2E(Q)-X12□18

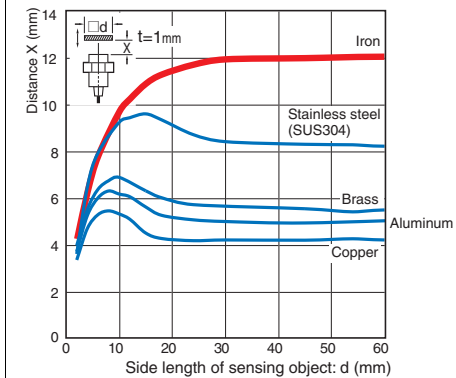

Size: M30 E2E(Q)-X22□30

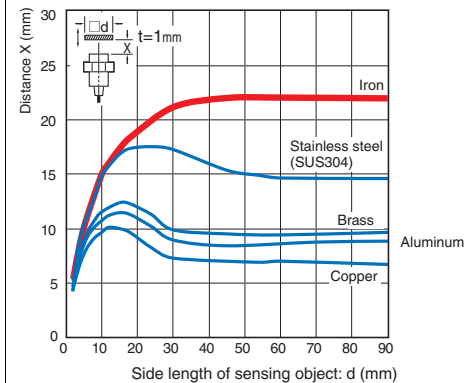

PREMIUM Model

Unshielded

Quadruple distance model

Size: M8 E2E-X8M□8

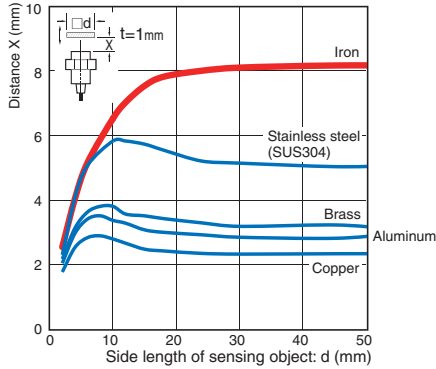

Size: M12 E2E-X16M□12

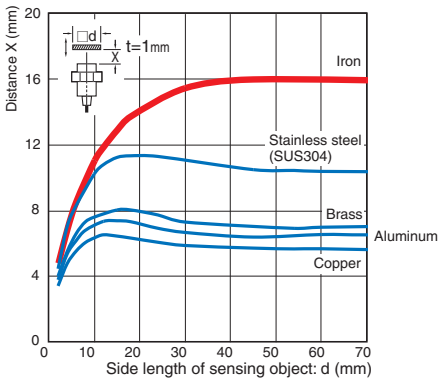

Size: M18 E2E-X30M□18

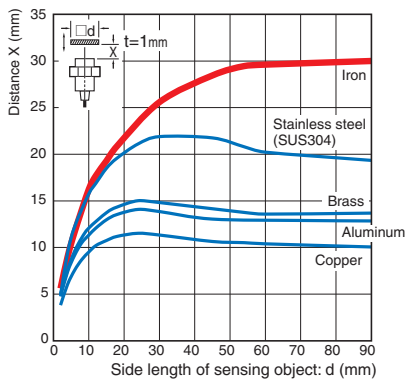

Size: M30 E2E-X50M□30

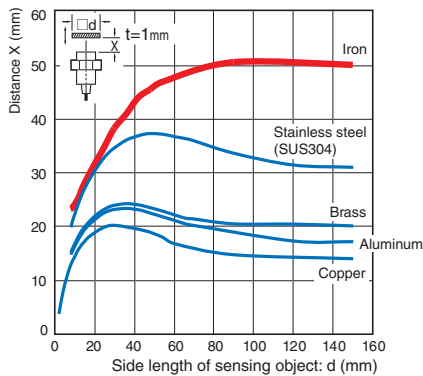

Triple distance model

Size: M8 E2E-X6M□8

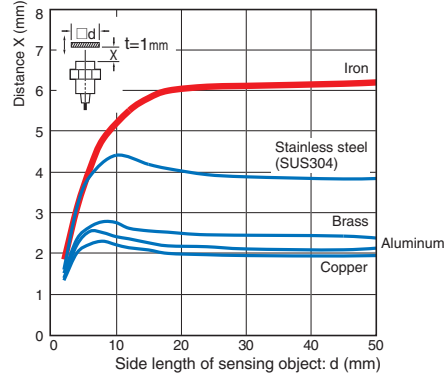

Size: M12 E2E-X10M□12

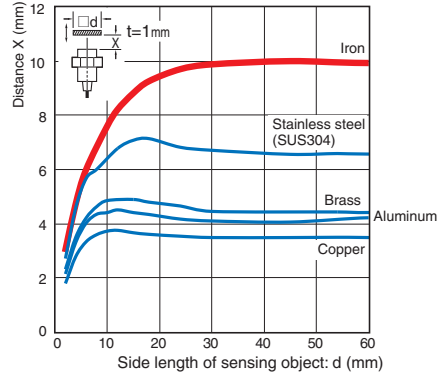

Size: M18 E2E-X20M□18

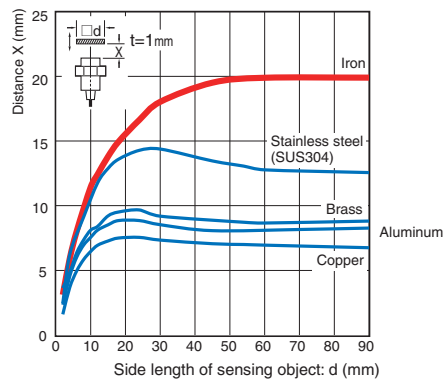

Size: M30 E2E-X40M□30

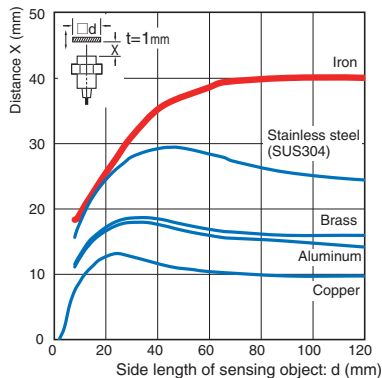

BASIC Model

Shielded

Double distance model, Spatter-resistant Double distance model

Size: M8 E2E(Q)-X2□8

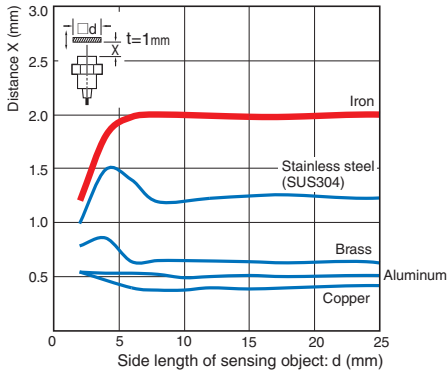

Single distance model, Spatter-resistant Single distance model

Size: M8 E2E(Q)-X1R5□8

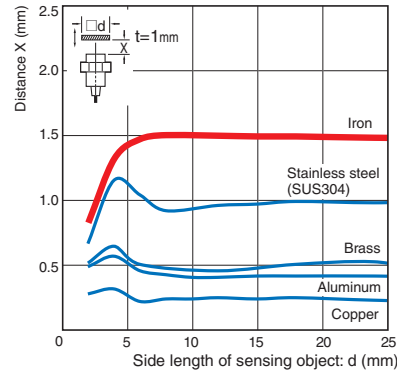

Size: M12 E2E(Q)-X4□12

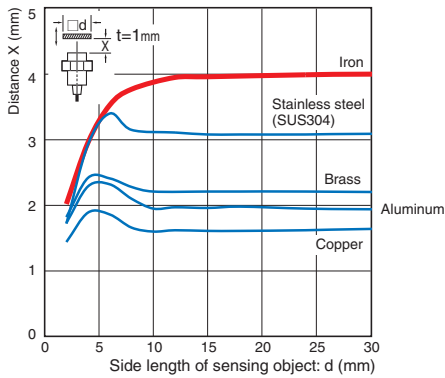

Size: M12 E2E(Q)-X2□12

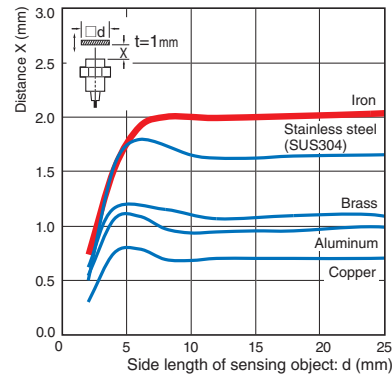

Size: M18 E2E(Q)-X8□18

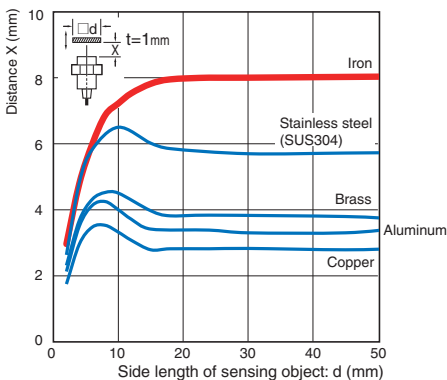

Size: M18 E2E(Q)-X5□18

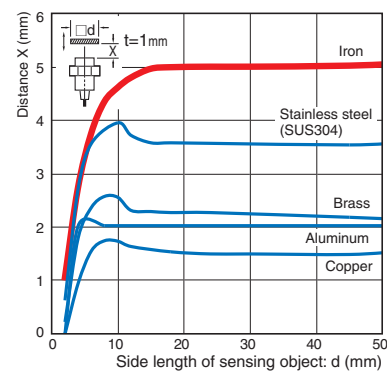

Size: M30 E2E(Q)-X15□30

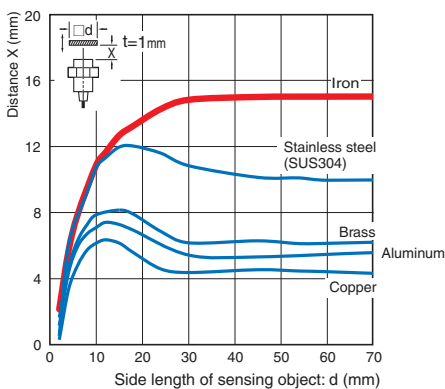

Size: M30 E2E(Q)-X10□30

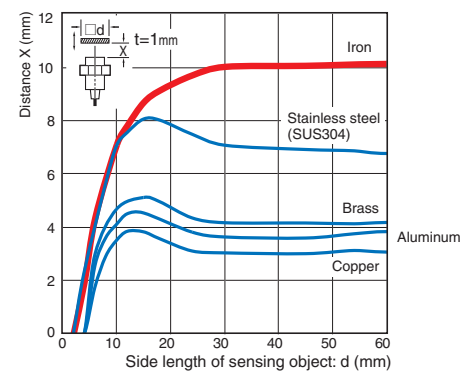

BASIC Model

Unshielded

Double distance model

Size: M8 E2E-X4M□8

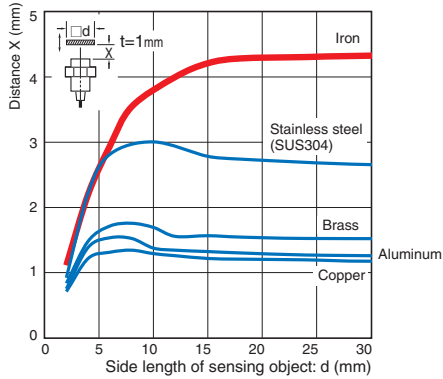

Size: M12 E2E-X8M□12

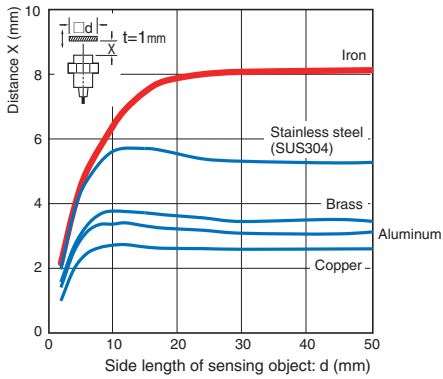

Size: M18 E2E-X16M□18

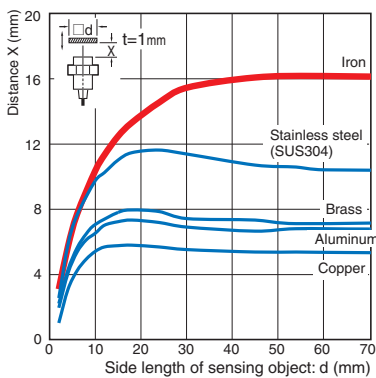

Size: M30 E2E-X30M□30

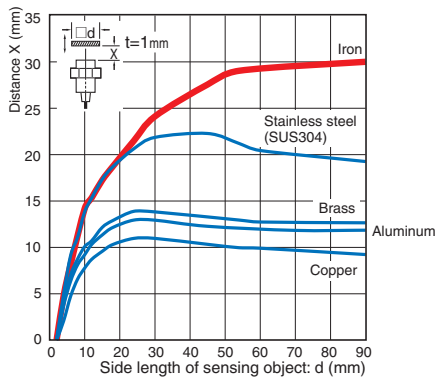

Single distance model

Size: M8 E2E-X2M□8

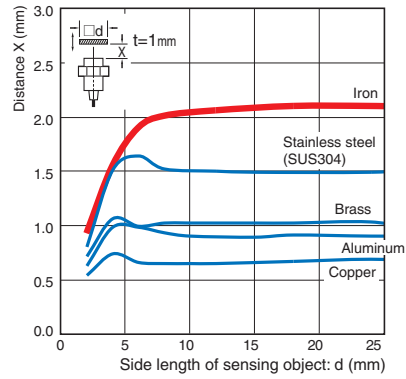

Size: M12 E2E-X5M□12

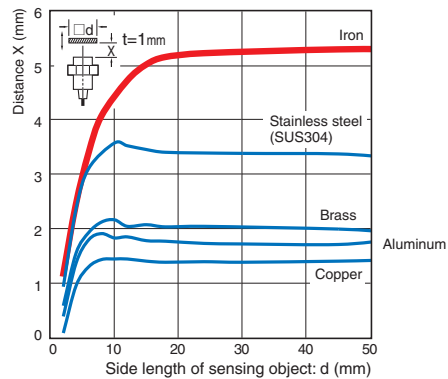

Size: M18 E2E-X10M□18

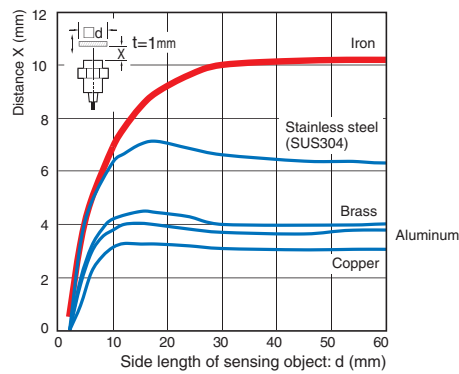

Size: M30 E2E-X18M□30

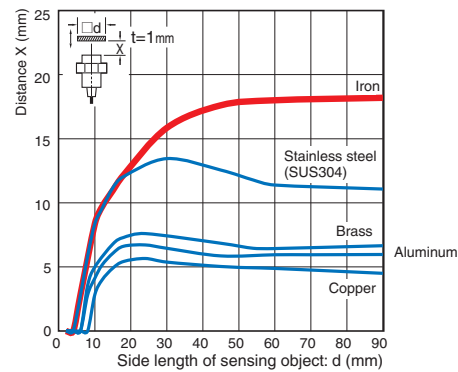

Monitor Output vs. Sensing Distance

PREMIUM Model

Shielded

Quadruple distance model

Size: M8 E2E-X4□8

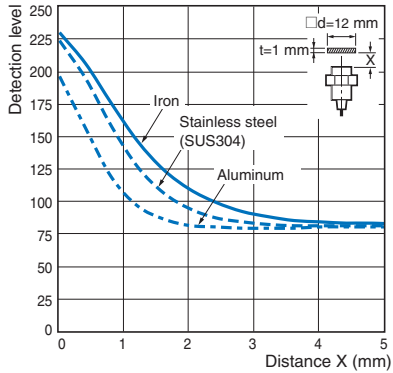

Size: M12 E2E-X9□12

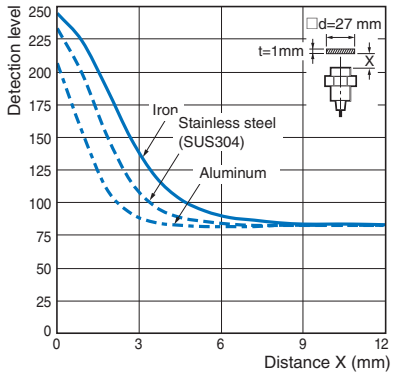

Size: M18 E2E-X14□18

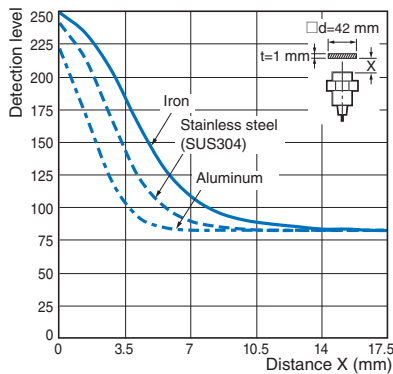

Size: M30 E2E-X23□30

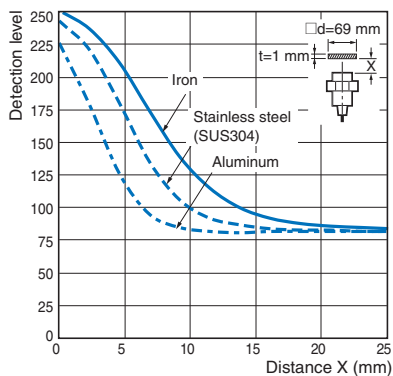

Triple model, Spatter-resistant Triple distance model

Size: M8 E2E(Q)-X3□8

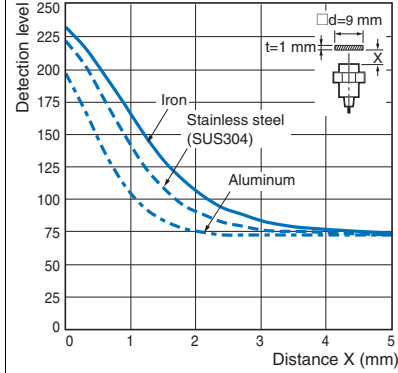

Size: M12 E2E(Q)-X6□12

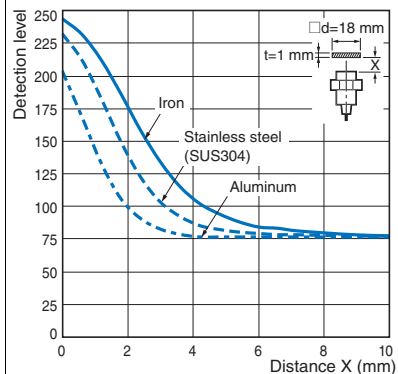

Size: M18 E2E(Q)-X12□18

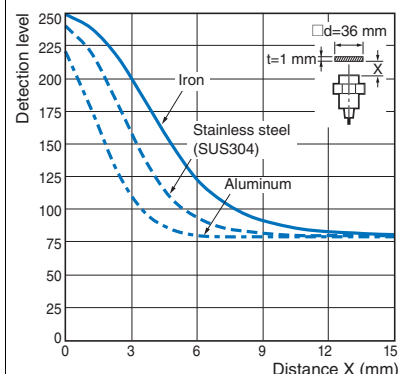

Size: M30 E2E(Q)-X22□30

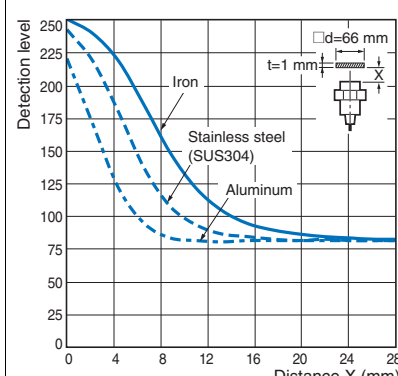

E2E/E2EQ NEXT Series DC 3-wire

E2E/E2EQ NEXT Series DC 2-wire

XSS5 NEXT Series

XSS

XSS3

PREMIUM Model

Unshielded

Quadruple distance model

Size: M8 E2E-X8M□8

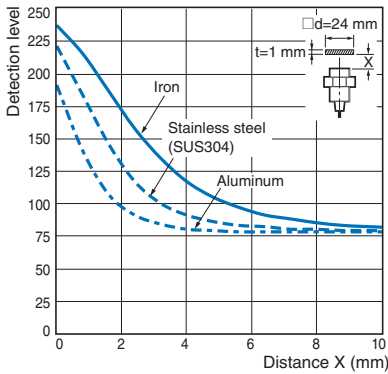

Size: M12 E2E-X16M□12

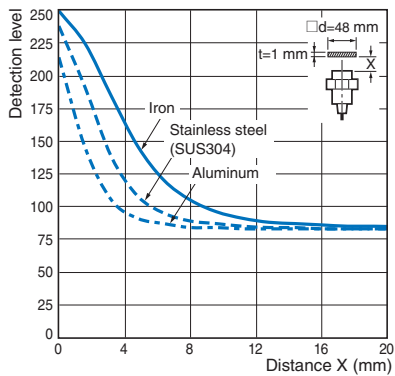

Size: M18 E2E-X30M□18

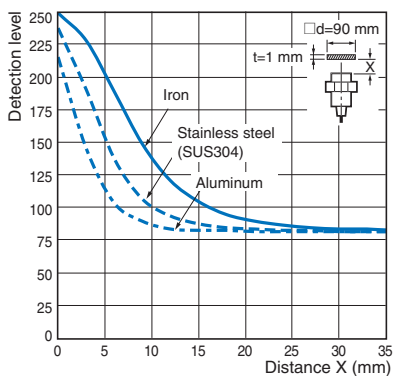

Size: M30 E2E-X50M□30

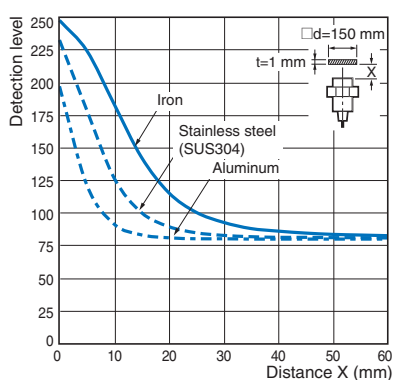

Triple distance model

Size: M8 E2E-X6M□8

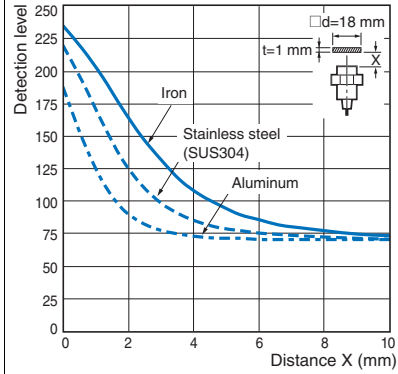

Size: M12 E2E-X10M□12

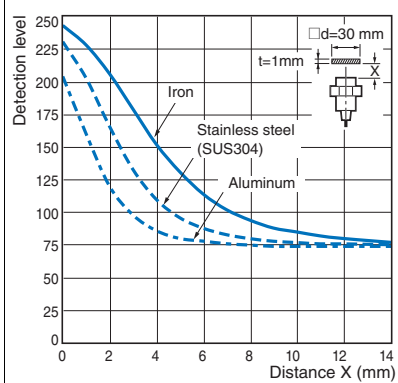

Size: M18 E2E-X20M□18

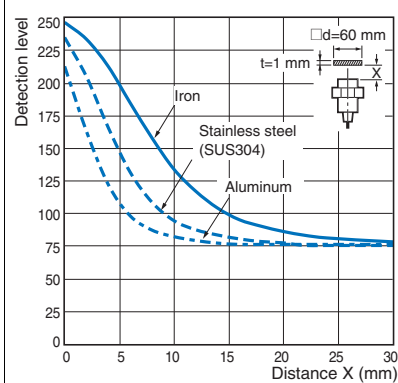

Size: M30 E2E-X40M□30

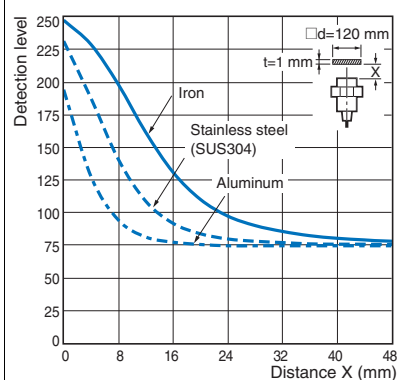

BASIC Model

Shielded

Double distance model, Spatter-resistant Double distance model

Size: M8 E2E(Q)-X2□8

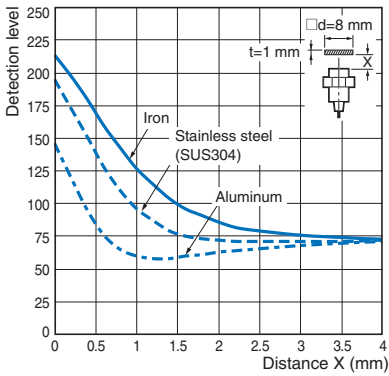

Size: M12 E2E(Q)-X4□12

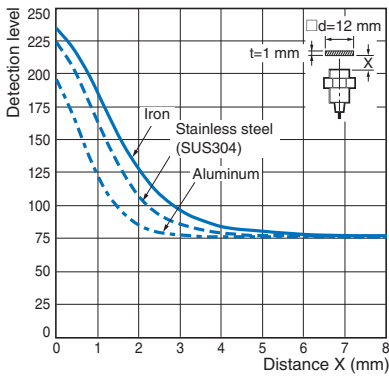

Size: M18 E2E(Q)-X8□18

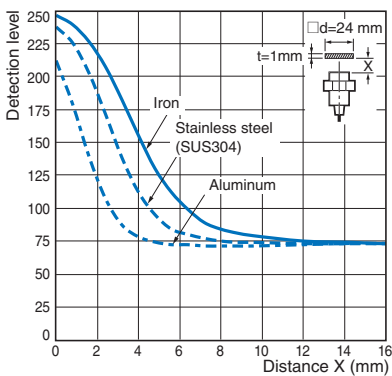

Size: M30 E2E(Q)-X15□30

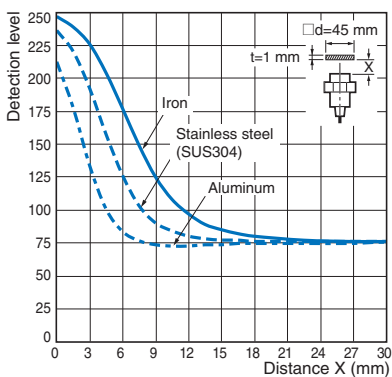

Single distance model, Spatter-resistant Single distance model

Size: M8 E2E(Q)-X1R5□8

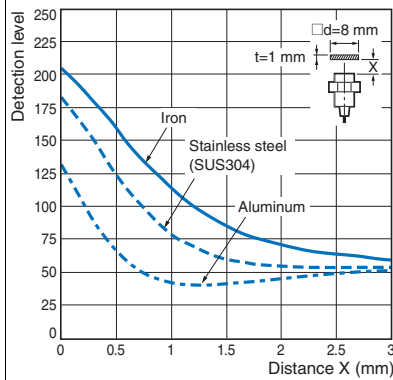

Size: M12 E2E(Q)-X2□12

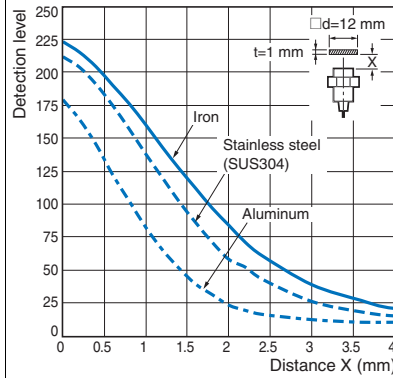

Size: M18 E2E(Q)-X5□18

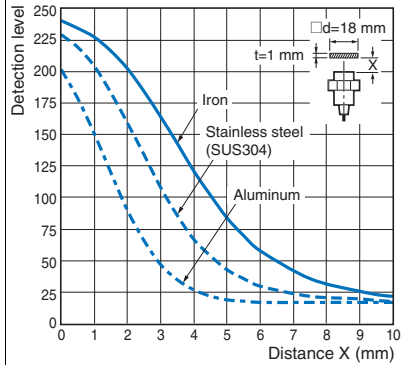

Size: M30 E2E(Q)-X10□30

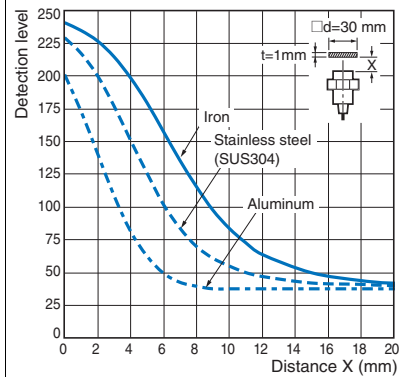

BASIC Model

Unshielded

Double distance model

Size: M8 E2E-X4M□8

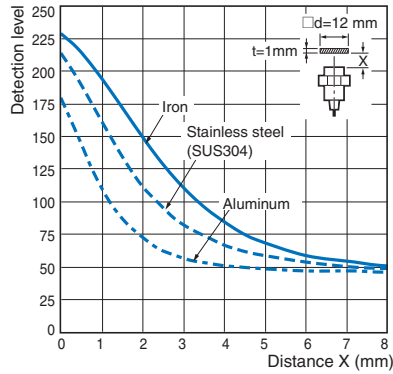

Size: M12 E2E-X8M□12

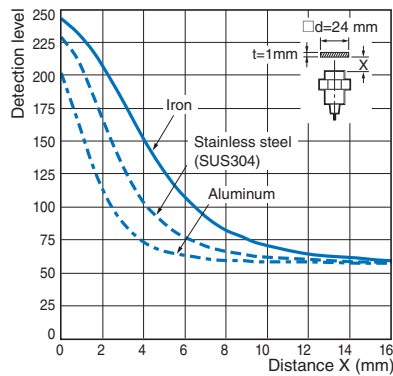

Size: M18 E2E-X16M□18

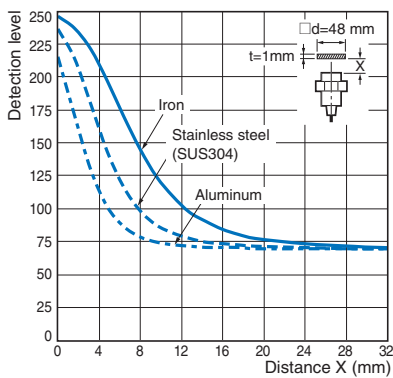

Size: M30 E2E-X30M□30

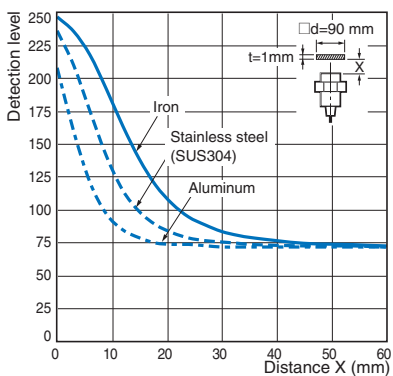

Single distance model

Size: M8 E2E-X2M□8

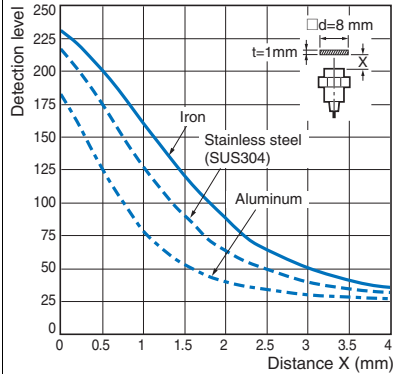

Size: M12 E2E-X5M□12

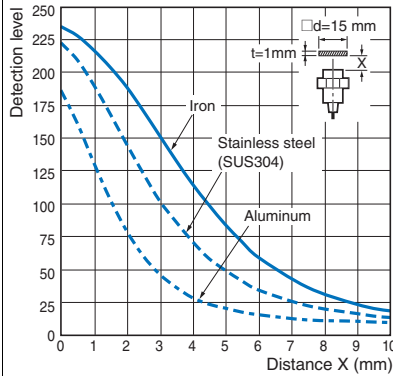

Size: M18 E2E-X10M□18

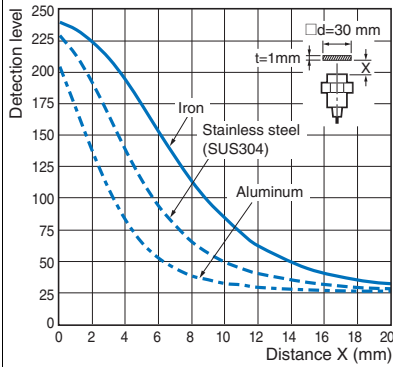

Size: M30 E2E-X18M□30

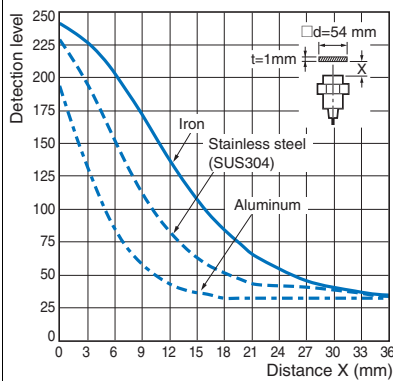

I/O Circuit Diagrams/Timing charts

DC 3-Wire
PNP output

Operation mode	Model	Output circuit	
		Standard I/O mode (SIO mode) When using as a general	IO-Link Communication mode (COM mode) When using the Sensor connected to IO-Link Master Unit *
NO	E2E(Q)-□B1		
NC	E2E(Q)-□B2	<p>Note: M8 (3-pin) Connector: (1)(4)(3)</p>	---
NO+NC	E2E(Q)-□B3		

* In the IO-Link mode, the cord between the IO-Link master and sensor must have a length of 20 m or less.

Connector Pin Arrangement

M12 Connector M12 Smartclick Connector	M8 (4-pin) Connector	M8 (3-pin) Connector

PNP output

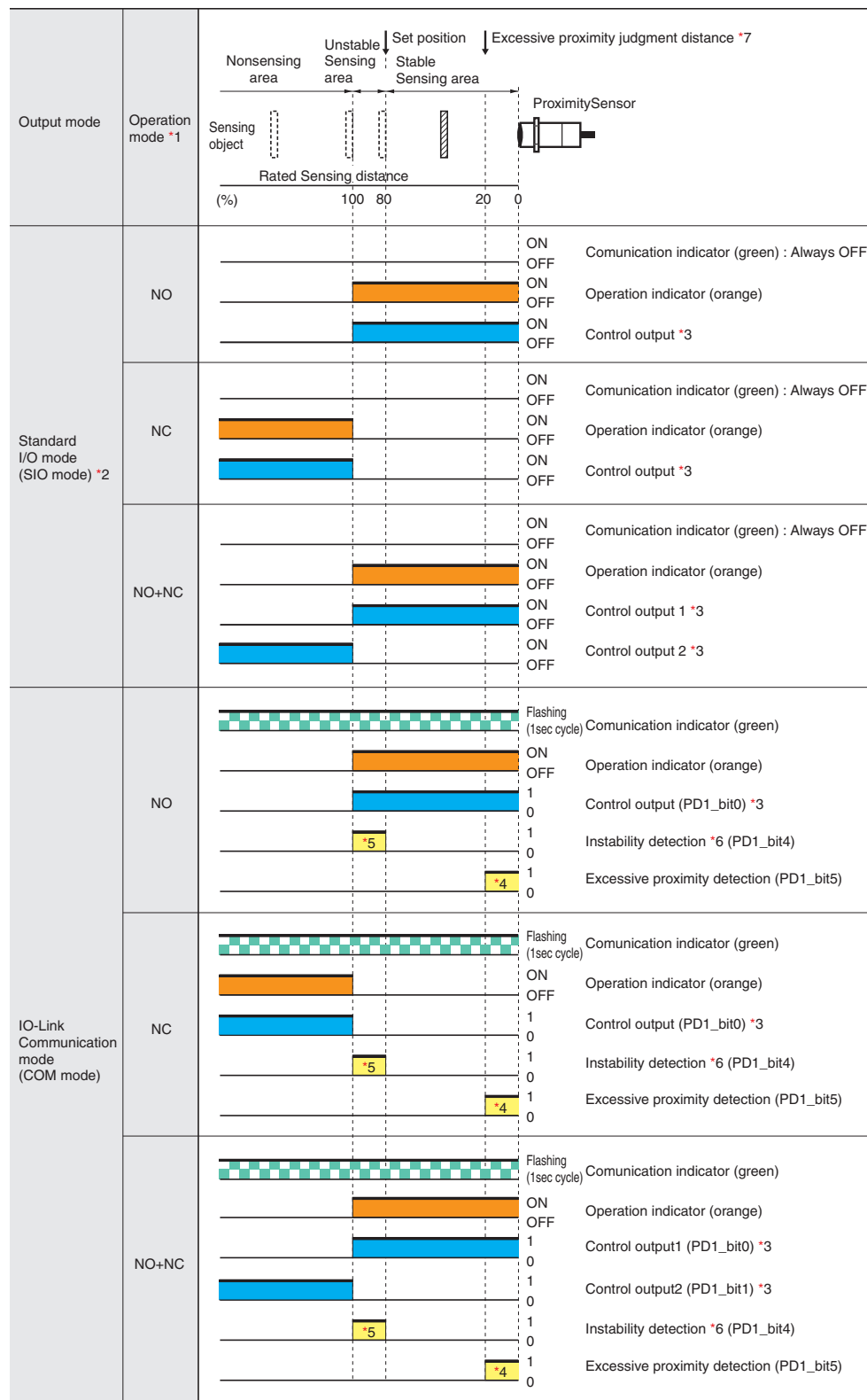

*3. The timer function of the control output can be set up by the IO-Link communications. (It is able to select ON delay, OFF delay, or one-shot function and select a timer time of 1 to 16,383ms (T).)

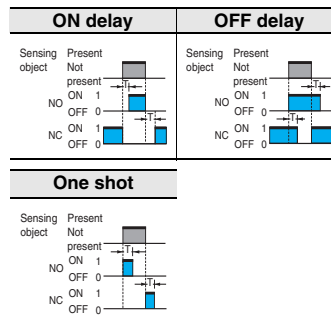

*4. The excessive proximity diagnosis function can be selected by the IO-Link communications.

*5. The instability detection diagnosis can be selected by the IO-Link communications.

*6. The judgment time for the instability detection diagnosis can be selected by the IO-Link communications. (For the ON delay timer function, the setting can be selected from 0 (invalid), 10, 50, 100, 300, 500, or 1000 ms.)

*7. The judgment distance of the excessive proximity diagnosis function can be selected by the IO-Link communications. (The distance can be selected as a combination of the material of the object detected, such as iron, aluminum, or SUS and the judgment distance of approximately 10, 20, or 30%. However, it is not allowed to select a combination of aluminum and 30%.)

Please contact your OMRON sales representative regarding the IO-Link setup file (IODD file).

Please contact your OMRON sales representative regarding assignment of data.

*1. For models with IO-Link, the operation mode can be changed by the IO-Link communications.

*2. If using a model with IO-Link as a general sensor or using a model without IO-Link, it operates in the standard I/O mode (SIO mode).

NPN output

Operation mode	Model	Output circuit
NO	E2E(Q)-□C1	
NC	E2E(Q)-□C2	<p>Note: M8 (3-pin) Connector: (1)(4)(3)</p>
NO+NC	E2E(Q)-□C3	

Connector Pin Arrangement

M12 Connector M12 Smartclick Connector	M8 (4-pin) Connector	M8 (3-pin) Connector

Operation mode	Sensing area		Proximity Sensor	Output	
	Nonsensing area	Stable sensing area		ON/OFF	Output Name
NO				ON OFF	Operation indicator (orange)
NC				ON OFF	Operation indicator (orange)
NO+NC				ON OFF ON OFF	Operation indicator (orange) Control output 1 Control output 2

E2E/E2EQ NEXT Series

Connections for Sensor I/O Connectors

DC 3-Wire

Proximity Sensor				Sensor I/O Connectors						
Types	Output	Operation mode	Model	Model	Connections *					
DC 3-Wire (M12 Connector/ M12 Smartclick Connector)	PNP	NO	E2E(Q)-X□B1□-M1TJ/ M1	XS5F-D421-□80-X□ XS5F-D42□-□80-F XS5W-D421-□81-X□ XS5W-D42□-□81-F Note: For details of the connector, refer to <i>XS5 NEXT Series</i> on page 87 refer to <i>XS5 Series</i> on page 94		E2E/E2EQ NEXT Series XS5 ○ Brown (+) ○ White (not connected) ○ Blue (-) ○ Black (Output)				
		NC	E2E(Q)-X□B2□-M1TJ/M1			E2E/E2EQ NEXT Series XS5 ○ Brown (+) ○ White (Output) ○ Blue (-) ○ Black (not connected)				
		NO+NC	E2E(Q)-X□B3□-M1TJ/M1			E2E/E2EQ NEXT Series XS5 ○ Brown (+) ○ White (Output 2) ○ Blue (-) ○ Black (Output 1)				
		NPN	NO		E2E(Q)-X□C1□-M1TJ/M1		E2E/E2EQ NEXT Series XS5 ○ Brown (+) ○ White (not connected) ○ Blue (-) ○ Black (Output)			
			NC		E2E(Q)-X□C2□-M1TJ/M1		E2E/E2EQ NEXT Series XS5 ○ Brown (+) ○ White (Output) ○ Blue (-) ○ Black (not connected)			
			NO+NC		E2E(Q)-X□C3□-M1TJ/M1		E2E/E2EQ NEXT Series XS5 ○ Brown (+) ○ White (Output 2) ○ Blue (-) ○ Black (Output 1)			
	DC 3-Wire (M8 Connector, 4-pin)		PNP		NO	E2E(Q)-X□B1□-M3	XS3W-M42□-4□-R XS3F-M42□-4□-R Note: For details of the connector, refer to <i>XS3 Series Datasheet</i> (No. G147).		E2E/E2EQ NEXT Series XS3 ○ Brown (+) ○ White (not connected) ○ Blue (-) ○ Black (Output)	
					NC	E2E(Q)-X□B2□-M3			E2E/E2EQ NEXT Series XS3 ○ Brown (+) ○ White (Output) ○ Blue (-) ○ Black (not connected)	
			NPN		NO	E2E(Q)-X□C1□-M3			E2E/E2EQ NEXT Series XS3 ○ Brown (+) ○ White (not connected) ○ Blue (-) ○ Black (Output)	
		NC			E2E(Q)-X□C2□-M3			E2E/E2EQ NEXT Series XS3 ○ Brown (+) ○ White (Output) ○ Blue (-) ○ Black (not connected)		
		DC 3-Wire (M8 Connector, 3-pin)	PNP		NO	E2E(Q)-X□B1□-M5		XS3W-M32□-3□-R XS3F-M32□-3□-R Note: For details of the connector, refer to <i>XS3 Series Datasheet</i> (No. G147).		E2E/E2EQ NEXT Series XS3 ○ Brown (+) ○ Black (Output) ○ Blue (-)
					NC	E2E(Q)-X□B2□-M5				E2E/E2EQ NEXT Series XS3 ○ Brown (+) ○ Black (Output) ○ Blue (-)
NPN	NO		E2E(Q)-X□C1□-M5		E2E/E2EQ NEXT Series XS3 ○ Brown (+) ○ Black (Output) ○ Blue (-)					
	NC		E2E(Q)-X□C2□-M5		E2E/E2EQ NEXT Series XS3 ○ Brown (+) ○ Black (Output) ○ Blue (-)					

Note: Different from Proximity Sensor wire colors.

* If the XS5W Series or XS3W Series Connector which has a socket and plug on the cable ends is connected to the Sensor, this part will be a plug.



Safety Precautions

Be sure to read the precautions for all models in the website at: <http://www.ia.omron.com/>.

Warning Indications

 WARNING	Warning level Indicates a potentially hazardous situation which, if not avoided, will result in minor or moderate injury, or may result in serious injury or death. Additionally there may be significant property damage.
Precautions for Safe Use	Supplementary comments on what to do or avoid doing, to use the product safely.
Precautions for Correct Use	Supplementary comments on what to do or avoid doing, to prevent failure to operate, malfunction or undesirable effect on product performance.

Meaning of Product Safety Symbols

	General prohibition Indicates the instructions of unspecified prohibited action.
	Caution, explosion Indicates the possibility of explosion under specific conditions.

WARNING

This product is not designed or rated for ensuring safety of persons either directly or indirectly. Do not use it for such purposes.



Otherwise, explosion may result. Never use the product with an AC power supply.



Precautions for Safe Use

The following precautions must be observed to ensure safe operation.

- Do not use the product in environments subject to flammable or explosive gases.
- Do not attempt to disassemble, repair, or modify the product.
- Do not use a voltage that exceeds the rated operating voltage range.
Applying a voltage that is higher than the operating voltage range may result in explosion or fire.
- Be sure that the power supply polarity and other wiring is correct. Incorrect wiring may cause explosion or fire.
- If the power supply is connected directly without a load, the internal elements may explode or burn.
- Be sure to insert a load when connecting the power supply.

Precautions for Correct Use

Do not use the product in any atmosphere or environment that exceeds the ratings.

Operating Environment

- Do not install the Sensor in the following locations.
 - Outdoor locations directly subject to sunlight, rain, snow, water droplets, or oil.
 - Locations subject to atmospheres with chemical vapors, in particular solvents and acids.
 - Locations subject to corrosive gases.
- The Sensor may malfunction if used near ultrasonic cleaning equipment, high-frequency equipment, transceivers, cellular phones, inverters, or other devices that generate a high-frequency electric field. Please refer to the Precautions for Correct Use on the OMRON website (www.ia.omron.com) for typical measures.
- Laying the Proximity Sensor wiring in the same conduit or duct as high-voltage wires or power lines may result in incorrect operation and damage due to induction. Wire the Sensor using a separate conduit or independent conduit.
- Never use thinner or other solvents. Otherwise, the Sensor surface may be dissolved.
- The following conditions shall be observed if you use the product under an environment using cutting oil that may affect product's life and/or performance.
 - Usage under the cutting oil condition designated by the specification
 - Usage under the cutting oil dilution ratio recommended by its manufacturer
 - Usage in oil or water is prohibited
 Impact on the product life may differ depending on the oil you use. Before using the cutting oil, make sure that it should not cause deterioration or degradation of sealing components.
- When turning on the power by influence of temperature environment, an output mis-pulse sometimes occurs. After the sensor has passed for 300 msec after turning on, please use in the stable state.
- The sensor is adjusted with a high degree of accuracy, so do not use in the environment with sudden temperature change.
- Operation check is performed using an OMRON's IO-Link master. If using an IO-Link master from another company, perform the operation check in advance.

E2E/E2EQ NEXT Series

Design

Influence of Surrounding Metal

When mounting the Proximity Sensor using a nut, only use the provided nut. And ensure that the minimum distances given in the following table are maintained.

When mounting the Proximity Sensor using a nut, only use the provided nut. Nuts that are supplied along with each Sensor are different. Refer to Dimensions for details on shapes.

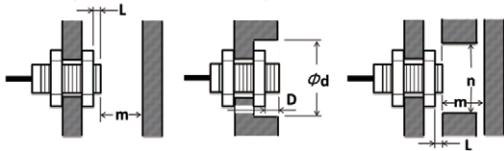

(Unit: mm)

Shielded

Type	Model	L	d	D	m	n
Quadruple distance model	E2E-X4□8	3	30	3	12	20
	E2E-X9□12	2	40	2	27	30
	E2E-X14□18	2	60	2	42	70
	E2E-X23□30	2	100	2	69	100
Triple distance model/ Spatter-resistant Triple distance model	E2E(Q)-X3□8	0	20	0	9	18
	E2E(Q)-X6□12	0	20	0	18	20
	E2E(Q)-X12□18	0	50	0	36	54
	E2E(Q)-X22□30	0	70	0	66	90
Double distance model/ Spatter-resistant Double distance model	E2E(Q)-X2□8	0	8	0	4.5	12
	E2E(Q)-X4□12	0	18	0	12	18
	E2E(Q)-X8□18	0	27	0	24	27
	E2E(Q)-X15□30	0	45	0	45	45
Single distance model/ Spatter-resistant Single distance model	E2E(Q)-X1R5□8	0	8	0	4.5	12
	E2E(Q)-X2□12	0	12	0	8	18
	E2E(Q)-X5□18	0	18	0	20	27
	E2E(Q)-X10□30	0	30	0	40	45

Unshielded

Models	Model	L	d	D	m	n
Quadruple distance model	E2E-X8M□8	12	40	12	24	40
	E2E-X16M□12	21	70	21	48	80
	E2E-X30M□18	46	130	46	90	110
	E2E-X50M□30	60	200	60	150	180
Triple distance model	E2E-X6M□8	10	30	10	18	30
	E2E-X10M□12	16	50	16	30	50
	E2E-X20M□18	31	90	31	60	80
	E2E-X40M□30 *	50	170	50	120	140
Double distance model	E2E-X4M□8	9	24	9	8	24
	E2E-X8M□12	11	40	11	20	40
	E2E-X16M□18	21	70	21	48	70
	E2E-X30M□30	40	120	40	90	120
Single distance model	E2E-X2M□8	6	24	6	8	24
	E2E-X5M□12	11	40	11	20	36
	E2E-X10M□18	18	55	18	40	54
	E2E-X18M□30	25	90	25	70	90

* If you use the model E2E-X40M□30, the panel thickness (t) is 4 mm or less.

When the Proximity Sensor is mounted in metal, ensure that the minimum distances given in the following table are maintained.

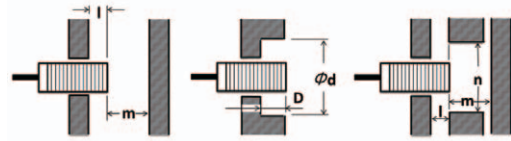

(Unit: mm)

Shielded

Models	Model	l	d	D	m	n
Quadruple distance model	E2E-X4□8	4	30	4	12	20
	E2E-X9□12	6	40	6	27	30
	E2E-X14□18	7	60	7	42	70
	E2E-X23□30	9	100	9	69	100
Triple distance model/ Spatter-resistant Triple distance model	E2E(Q)-X3□8	2	20	2	9	18
	E2E(Q)-X6□12	4	20	4	18	20
	E2E(Q)-X12□18	4	50	4	36	54
	E2E(Q)-X22□30	8	70	8	66	90
Double distance model/ Spatter-resistant Double distance model	E2E(Q)-X2□8	0	8	0	4.5	12
	E2E(Q)-X4□12	2.4	18	2.4	12	18
	E2E(Q)-X8□18	3.6	27	3.6	24	27
	E2E(Q)-X15□30	6	45	6	45	45
Single distance model/ Spatter-resistant Single distance model	E2E(Q)-X1R5□8	0	8	0	4.5	12
	E2E(Q)-X2□12	0	12	0	8	18
	E2E(Q)-X5□18	0	18	0	20	27
	E2E(Q)-X10□30	0	30	0	40	45

Unshielded

Models	Model	l	d	D	m	n
Quadruple distance model	E2E-X8M□8	15	40	15	24	40
	E2E-X16M□12	25	70	25	48	80
	E2E-X30M□18	50	130	50	90	110
	E2E-X50M□30	65	200	65	150	180
Triple distance model	E2E-X6M□8	13	30	13	18	30
	E2E-X10M□12	20	50	20	30	50
	E2E-X20M□18	35	90	35	60	80
	E2E-X40M□30 *	55	170	55	120	140
Double distance model	E2E-X4M□8	12	24	12	8	24
	E2E-X8M□12	15	40	15	20	40
	E2E-X16M□18	25	70	25	48	70
	E2E-X30M□30	45	120	45	90	120
Single distance model	E2E-X2M□8	6	24	6	8	24
	E2E-X5M□12	15	40	15	20	36
	E2E-X10M□18	22	55	22	40	54
	E2E-X18M□30	30	90	30	70	90

* If you use the model E2E-X40M□30, the panel thickness (t) is 4 mm or less.

Mutual Interference

When installing two or more Proximity Sensors face-to-face or side-by-side, ensure that the minimum distances given in the following table are maintained.

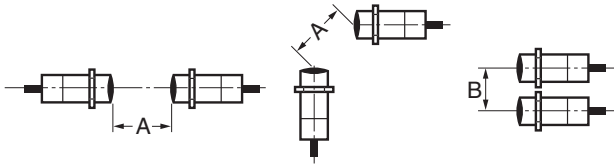

(Unit: mm)

Shielded

Models	Model	Item	
		A	B
Quadruple distance model	E2E-X4□8	40	20
	E2E-X9□12	60	35
	E2E-X14□18	90	50
	E2E-X23□30	150	90
Triple distance model/ Spatter-resistant Triple distance model	E2E(Q)-X3□8	25	20
	E2E(Q)-X6□12	40	30
	E2E(Q)-X12□18	70	45
	E2E(Q)-X22□30	150	90
Double distance model/ Spatter-resistant Double distance model	E2E(Q)-X2□8	20	15
	E2E(Q)-X4□12	30	20
	E2E(Q)-X8□18	60	35
	E2E(Q)-X15□30	110	90
Single distance model/ Spatter-resistant Single distance model	E2E(Q)-X1R5□8	20	15
	E2E(Q)-X2□12	30	20
	E2E(Q)-X5□18	50	35
	E2E(Q)-X10□30	100	70

Unshielded

Models	Model	Item	
		A	B
Quadruple distance model	E2E-X8M□8	80	60
	E2E-X16M□12	160	120
	E2E-X30M□18	360	300
	E2E-X50M□30	700	480
Triple distance model	E2E-X6M□8	80	60
	E2E-X10M□12	120	100
	E2E-X20M□18	200	120
	E2E-X40M□30	380	300
Double distance model	E2E-X4M□8	80	60
	E2E-X8M□12	120	100
	E2E-X16M□18	200	120
	E2E-X30M□30	350	300
Single distance model	E2E-X2M□8	80	60
	E2E-X5M□12	120	100
	E2E-X10M□18	200	110
	E2E-X18M□30	300	200

Mounting

Tightening Force

Do not tighten the nut with excessive force. A washer must be used with the nut.

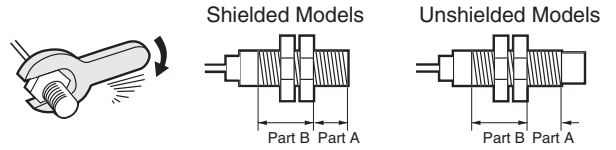

- Note:**
- The allowable tightening strength depends on the distance from the edge of the head, as shown in the following table. (A is the distance from the edge of the head. B includes the nut on the head side. If the edge of the nut is in part A, the tightening torque for part A applies instead.)
 - The following strengths assume washers are being used.

Quadruple distance model, Triple distance model, Spatter-resistant Triple distance model

Size	Shielded	Part A		Part B
		Dimension (mm)	Torque	Torque
M8	Shielded	9	4 N·m	10 N·m
	Unshielded	3		
M12	Shielded	16	6 N·m	15 N·m
	Unshielded	9		
M18	Shielded	16	15 N·m	60 N·m (30 N·m*)
	Unshielded	3		
M30	Shielded	23	40 N·m	80 N·m
	Unshielded	8		

* If using the E2EQ (M18), refer to this torque value.

Double distance model, Single distance model, Spatter-resistant Triple distance model, Spatter-resistant Single distance model

Size	Shielded	Part A		Part B
		Dimension (mm)	Torque	Torque
M8	Shielded	9	9 N·m	12 N·m
	Unshielded	3		
M12	---	---	30 N·m	
M18	---	---	70 N·m	
M30	---	---	180 N·m (100 N·m*)	

* If using the E2EQ (M30), refer to this torque value.

E2E/E2EQ NEXT Series

Dimensions

(Unit: mm)

Tolerance class IT16 applies to dimensions in this data sheet unless otherwise specified.

Sensors

PREMIUM Model

E2E/E2EQ NEXT Series

(Quadruple distance/Triple distance/Spatter-resistant, Triple distance model)

DC 3-Wire

Pre-wired Model/Pre-wired Connector Model
Shielded/Unshielded



Connector Models
(M12 Connector, M8 (4-pin) Connector and M8 (3-pin) Connector)
Shielded/Unshielded

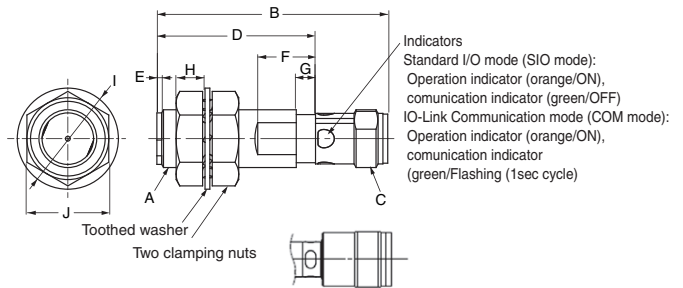
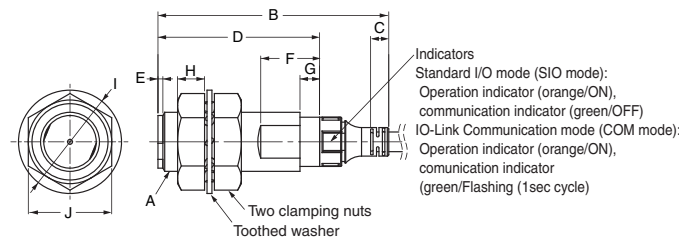

Model E2E(Q)-X□8-M1;
Shape of connection.

Pre-wired Models

(Operation mode: NO, NC Type)

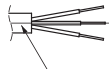

Vinyl-insulated round cable with 3 conductors
M8, M12 size: 4-dia.
M18, M30 size: 6-dia.
(Conductor cross section: 0.2 mm² (AWG24),
Insulator diameter: 1.05 mm),
Standard length: 2 m

(Operation mode: NO+NC Type)

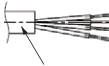

Vinyl-insulated round cable with 4 conductors
M12 size: 4.3-dia.
M18/M30 size: 6-dia.
(Conductor cross section: 0.2 mm² (AWG24),
Insulator diameter: 1.05 mm),
Standard length: 2 m

Pre-wired Connector Models (M12J)

(Operation mode: NO, NC Type)



Vinyl-insulated round cable with 3 conductors
M8, M12 size: 4-dia.
M18, M30 size: 6-dia.
(Conductor cross section: 0.2 mm² (AWG24),
Insulator diameter: 1.05 mm),
Standard length: 0.3 m

(Operation mode: NO+NC Type)

Vinyl-insulated round cable with 4 conductors
M12 size: 4.3-dia.
M18, M30 size: 6-dia.
(Conductor cross section: 0.2 mm² (AWG24),
Insulator diameter: 1.05 mm),
Standard length: 0.3 m

Shielded

Model	A	B	C	D	E	F	G*	H	I	J
E2E(Q)-X□8-M3/M5	M8XP1	39	M8XP1	26	1	10	4	4	15	13
E2E(Q)-X□8-M1	M8XP1	43	M12XP1	26	1	10	4	4	15	13
E2E(Q)-X□12-M1	M12XP1	48	M12XP1	33	1	12	4	5.5	21	17
E2E(Q)-X□18-M1	M18XP1	53	M12XP1	38	1	12	4	6	29	24
E2E(Q)-X□30-M1	M30XP1.5	58	M12XP1	43	1	12	4	7	42	36
E2E-X□L8-M3/M5	M8XP1	49	M8XP1	36	1	10	---	4	15	13
E2E-X□L8-M1	M8XP1	53	M12XP1	36	1	10	---	4	15	13
E2E-X□L12-M1	M12XP1	70	M12XP1	55	1	12	---	5.5	21	17
E2E-X□L18-M1	M18XP1	75	M12XP1	60	1	12	---	6	29	24
E2E-X□L30-M1	M30XP1.5	80	M12XP1	65	1	12	---	7	42	36

Unshielded

Model	A	B	C	D	E	F	G*	H	I	J
E2E-X□M□8-M3/M5	M8XP1	39	M8XP1	26	6	8	---	3	15	13
E2E-X□M□8-M1	M8XP1	43	M12XP1	26	6	8	---	3	15	13
E2E-X□M□12-M1	M12XP1	48	M12XP1	33	7	10	---	4	21	17
E2E-X□M□L8-M3/M5	M8XP1	49	M8XP1	36	6	8	---	3	15	13
E2E-X□M□L8-M1	M8XP1	53	M12XP1	36	6	8	---	3	15	13
E2E-X□M□L12-M1	M12XP1	70	M12XP1	55	7	10	---	4	21	17
E2E-X□M□L18-M1	M18XP1	75	M12XP1	60	13	12	---	4	29	24
E2E-X40M□L30-M1	M30XP1.5	80	M12XP1	65	15	10	---	5	42	36
E2E-X50M□L30-M1	M30XP1.5	95	M12XP1	80	15	12	---	5	42	36

* Mounting part of sensor lock O-ring (Y92E-J□S□) ---: Out of a subject.

Shielded

Model	A	B	C	D	E	F	G*	H	I	J
E2E(Q)-X□8	M8XP1	37.8	4.4	26	1	10	4	4	15	13
E2E(Q)-X□12	M12XP1	47.1	3.7	33	1	12	4	5.5	21	17
E2E(Q)-X□18	M18XP1	55.3	8.5	38	1	12	4	6	29	24
E2E(Q)-X□30	M30XP1.5	60.3	8.3	43	1	12	4	7	42	36
E2E-X□L8	M8XP1	47.8	4.4	36	1	10	---	4	15	13
E2E-X□L12	M12XP1	69.1	3.7	55	1	12	---	5.5	21	17
E2E-X□L18	M18XP1	77.3	8.5	60	1	12	---	6	29	24
E2E-X□L30	M30XP1.5	82.3	8.3	65	1	12	---	7	42	36

Unshielded

Model	A	B	C	D	E	F	G*	H	I	J
E2E-X□M□8	M8XP1	37.8	4.4	26	6	8	---	3	15	13
E2E-X□M□12	M12XP1	47.1	3.7	33	7	10	---	4	21	17
E2E-X□M□L8	M8XP1	47.8	4.4	36	6	8	---	3	15	13
E2E-X□M□L12	M12XP1	69.1	3.7	55	7	10	---	4	21	17
E2E-X□M□L18	M18XP1	77.3	8.5	60	13	12	---	4	29	24
E2E-S05S12□	M30XP1.5	82.3	8.3	65	15	10	---	5	42	36
E2E-S05S12□	M30X1.5	97.3	8.3	80	15	12	---	5	42	36

* Mounting part of sensor lock O-ring (Y92E-J□S□) ---: Out of a subject.

Mounting Hole Dimensions



Dimensions	F (mm)
M8	8.5 dia. ^{+0.5} / ₀
M12	12.5 dia. ^{+0.5} / ₀
M18	18.5 dia. ^{+0.5} / ₀
M30	30.5 dia. ^{+0.5} / ₀

Angle R of the Bending Wire

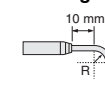

Dimensions	R (mm)
M8	12
M12	
M18	18
M30	

Wire pullout position

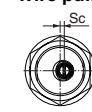

Dimensions	Sc (mm)
M8	-(0)
M12	
M18	2.5
M30	

BASIC Model

E2E/E2EQ NEXT Series

(Double distance/Single distance/Spatter-resistant, Double distance/Single distance model)

DC 3-Wire

Pre-wired Model/Pre-wired Connector Model
Shielded/Unshielded

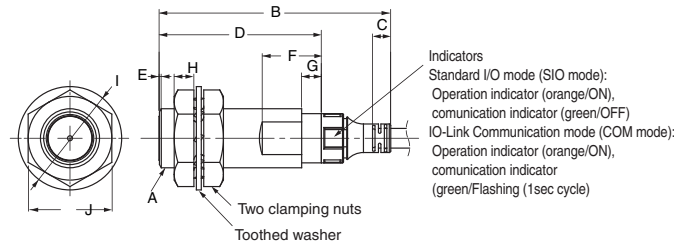

Pre-wired Models
(Operation mode: NO, NC Type)

Pre-wired Connector Models (M1TJ)
M12xP1

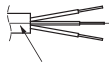

Vinyl-insulated round cable with 3 conductors
M8, M12 size: 4-dia.
M18, M30 size: 6-dia.
(Conductor cross section: 0.2 mm² (AWG24),
Insulator diameter: 1.05 mm),
Standard length: 2 m

(Operation mode: NO+NC Type)



Vinyl-insulated round cable with 4 conductors
M12 size: 4.3-dia.
M18, M30 size: 6-dia.
(Conductor cross section: 0.2 mm² (AWG24),
Insulator diameter: 1.05 mm),
Standard length: 2 m



(Operation mode: NO, NC Type)
Vinyl-insulated round cable with 3 conductors
M8, M12 size: 4-dia.
M18, M30 size: 6-dia.
(Conductor cross section: 0.2 mm² (AWG24),
Insulator diameter: 1.05 mm),
Standard length: 0.3 m

(Operation mode: NO+NC Type)
Vinyl-insulated round cable with 4 conductors
M12 size: 4.3-dia.
M18, M30 size: 6-dia.
(Conductor cross section: 0.2 mm² (AWG24),
Insulator diameter: 1.05 mm),
Standard length: 0.3 m

Shielded

Model	A	B	C	D	E	F*1	G*2	H	I	J
E2E(Q)-X□8	M8XP1	37.8	4.4	26	---	10 (8)	4	3	15	13
E2E(Q)-X□12	M12XP1	47.1	3.7	33	---	12 (10)	4	4	21	17
E2E(Q)-X□18	M18XP1	55.3	8.5	38	---	12 (10)	4	4	29	24
E2E(Q)-X□30	M30XP1.5	60.3	8.3	43	---	12 (10)	4	5	42	36
E2E-X□L8	M8XP1	47.8	4.4	36	---	8	---	3	15	13
E2E-X□L12	M12XP1	69.1	3.7	55	---	10	---	4	21	17
E2E-X□L18	M18XP1	77.3	8.5	60	---	10	---	4	29	24
E2E-X□L30	M30XP1.5	82.3	8.3	65	---	10	---	5	42	36

Unshielded

Model	A	B	C	D	E*3	F	G*2	H	I	J
E2E-X□M□8	M8XP1	37.8	4.4	26	6	8	---	3	15	13
E2E-X□M□12	M12XP1	47.1	3.7	33	7	10	---	4	21	17
E2E-X□M□18	M18XP1	55.3	8.5	38	10	10	---	4	29	24
E2E-X□M□30	M30XP1.5	60.3	8.3	43	13	10	---	5	42	36
E2E-X□M□L8	M8XP1	47.8	4.4	36	6	8	---	3	15	13
E2E-X□M□L12	M12XP1	69.1	3.7	55	7	10	---	4	21	17
E2E-X□M□L18	M18XP1	77.3	8.5	60	10	10	---	4	29	24
E2E-X□M□L30	M30XP1.5	82.3	8.3	65	13 (15)	10	---	5	42	36

*1. If using the E2EQ, refer to () dimensions.

*2. Mounting part of sensor lock O-ring (Y92E-J□S□) ---: Out of a subject.

*3. When using X30M□30, refer to (15).

Connector Models

(M12 Connector, M8 (4-pin) Connector and M8 (3-pin) Connector)
Shielded/Unshielded

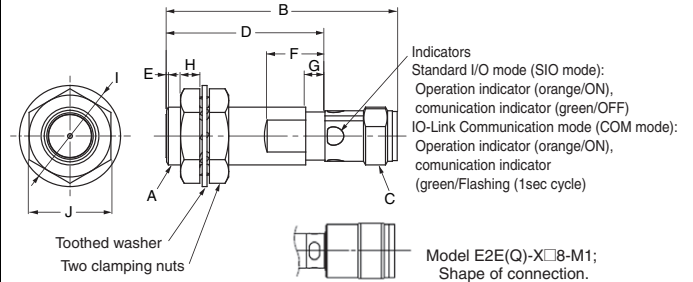

Shielded

Model	A	B	C	D	E	F*1	G*2	H	I	J
E2E(Q)-X□30 X□8-M3/M5	M8XP1	39	M8XP1	26	---	10 (8)	4	3	15	13
E2E(Q)-X□8-M1	M8XP1	43	M12XP1	26	---	10 (8)	4	3	15	13
E2E(Q)-X□12-M1	M12XP1	48	M12XP1	33	---	12 (10)	4	4	21	17
E2E(Q)-X□18-M1	M18XP1	53	M12XP1	38	---	12 (10)	4	4	29	24
E2E(Q)-X□30-M1	M30XP1.5	58	M12XP1	43	---	12 (10)	4	5	42	36
E2E-X□L8-M3/M5	M8XP1	49	M8XP1	36	---	8	---	3	15	13
E2E-X□L8-M1	M8XP1	53	M12XP1	36	---	8	---	3	15	13
E2E-X□L12-M1	M12XP1	70	M12XP1	55	---	10	---	4	21	17
E2E-X□L18-M1	M18XP1	75	M12XP1	60	---	10	---	4	29	24
E2E-X□L30-M1	M30XP1.5	80	M12XP1	65	---	10	---	5	42	36

Unshielded

Model	A	B	C	D	E*3	F	G*2	H	I	J
E2E-X□M□8-M3/M5	M8XP1	39	M8XP1	26	6	8	---	3	15	13
E2E-X□M□8-M1	M8XP1	43	M12XP1	26	6	8	---	3	15	13
E2E-X□M□12-M1	M12XP1	48	M12XP1	26	7	10	---	4	21	17
E2E-X□M□18-M1	M18XP1	53	M12XP1	38	10	10	---	4	29	24
E2E-X□M□30-M1	M30XP1.5	58	M12XP1	43	13	10	---	5	42	36
E2E-X□M□L8-M3-M5	M8XP1	49	M8XP1	36	6	8	---	3	15	13
E2E-X□M□L8-M1	M8XP1	53	M12XP1	36	6	8	---	3	15	13
E2E-X□M□L12-M1	M12XP1	70	M12XP1	55	7	10	---	4	21	17
E2EX□M□L18-M1	M18XP1	75	M12XP1	60	10	10	---	4	29	24
E2E-X□M□L30-M1	M30XP1.5	80	M12XP1	65	13 (15)	10	---	5	42	36

*1. If using the E2EQ, refer to () dimensions.

*2. Mounting part of sensor lock O-ring (Y92E-J□S□) ---: Out of a subject.

*3. When using X30M□30, refer to (15).

Mounting Hole Dimensions



Dimensions	F (mm)
M8	8.5 dia. +0.5 / 0
M12	12.5 dia. +0.5 / 0
M18	18.5 dia. +0.5 / 0
M30	30.5 dia. +0.5 / 0

Angle R of the Bending Wire

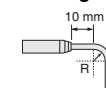

Dimensions	R (mm)
M8	12
M12	12
M18	18
M30	18

Wire pullout position

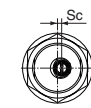

Dimensions	Sc (mm)
M8	-(0)
M12	-(0)
M18	2.5
M30	2.5

Accessories (Sold Separately)

e-jig (Mounting Sleeves)

Y92E-J8S12

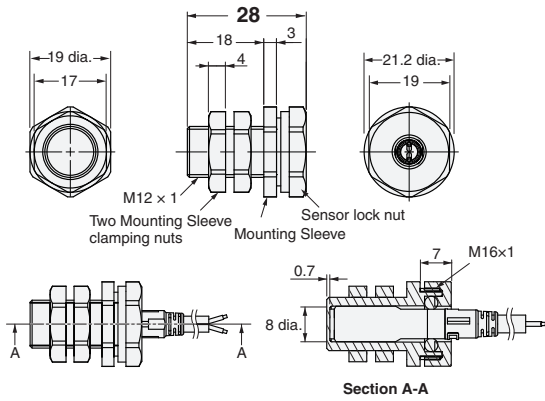

Y92E-J12S18

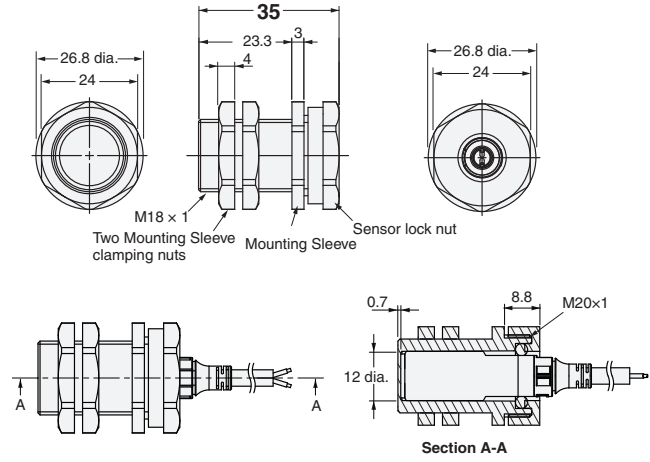

Y92E-J18S30

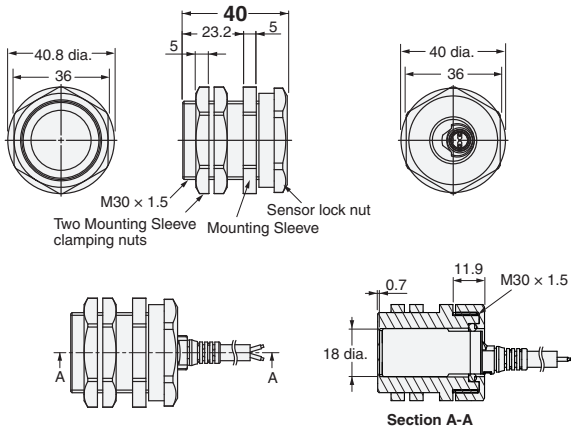

Material

Mounting Sleeve	Polyetheretherketone (PEEK) / Polybutylene terephthalate (PBT)
Mounting Sleeve clamping nut	Polybutylene terephthalate (PBT)
Sensor lock nut	Polybutylene terephthalate (PBT)
Sensor lock O-ring	Material combining HNBR and fluororubber

Tightening Force

Model	Torque	
	Mounting Sleeve clamping nut	Sensor lock nut
Y92E-J8S12	0.6 N·m	0.6 N·m
Y92E-J12S18	1.2 N·m	1.2 N·m
Y92E-J18S30	5 N·m	3.5 N·m

Long-distance Detection Prevents Unexpected Facility Stoppages

- The world's longest sensing distance*¹
Nearly double the sensing distance of previous
- With high-brightness LED, the indicator is visible anywhere from 360°.
- Only 10 Seconds*² to Replace a Proximity Sensor with the "e-jig" (Mounting Sleeve).
- Cables with enhanced oil resistance enabled 2-year oil resistance*³.
- UL certification (UL60947-5-2) and CSA certification (CSA C22.2 UL60947-5-2-14)



For the most recent information on models that have been certified for safety standards, refer to your OMRON website.

*1. Based on July 2017 OMRON investigation.
*2. Time required to adjust the distance when installing a Sensor. Based on OMRON investigation.
*3. Refer to page 72 and 74 for details. However, E2EQ series is excluded.

Be sure to read *Safety Precautions* on page 80.

E2E/E2EQ NEXT Series Model Number Legend

DC 2-wire

E2E (1) - X (2) (3) D (4) (5) (6) - (7) - (8) (9) - (10) (11)

No.	Classification	Code	Meaning
(1)	Case	Blank	Without spatter-resistant coating
		Q	With spatter-resistant coating
(2)	Sensing distance	Number	Sensing distance (Unit: mm) (R: Indication of decimal point)
(3)	Shielding	Blank	Shielded Models
		M	Unshielded Models
(4)	Operation mode	1	Normally open (NO)
		2	Normally closed (NC)
(5)	Body size	Blank	Standard
		L	Long Body
(6)	Size (Omitted for the Single distance type.)	8	M8
		12	M12
		18	M18
		30	M30
(7)	Connecting method	Blank	Pre-wired Models
		M1TGJ	M12 Pre-wired Smartclick Connector Models
		M1TGJR	M12 Pre-wired Smartclick Connector Models (Robot (bending-resistant) PVC cable)
(8)	Polarity	Blank	Polarity
		T	No polarity
(9)	Cable specifications *	Blank	Standard PVC cable
		R	Robot (bending-resistant) PVC cable
(10)	New model	Blank	Other than Single distance model (Pre-wired Models)
		N	Single distance model (Applicable only to Pre-wired Models)
(11)	Cable length	Number M	Cable length

* (9) is only shown in the model number of Pre-wired Models.

Note: 1. The purpose of this model number legend is to provide understanding of the meaning of specifications from the model number. Models are not available for all combinations of code numbers.
2. Size description of the number 7 is not included in the Single-distance type.

E2E/E2EQ NEXT Series

Ordering Information

Sensors

E2E NEXT Series (Triple distance model)

DC 2-wire [Refer to *Dimensions* on page 82.]

Shielded Models *1

Size (Sensing distance)	Connection method	Polarity	Model	
			Operation mode: NO	Operation mode: NC
M8 (3 mm)	Pre-wired (2 m) *2 *3	Yes	E2E-X3D18 2M	E2E-X3D28 2M
		No	E2E-X3D18-T 2M	E2E-X3D28-T 2M
	M12 Pre-wired Smartclick Connector (0.3 m) *4	Yes	E2E-X3D18-M1TGJ 0.3M	E2E-X3D28-M1TGJ 0.3M
		No	E2E-X3D18-M1TGJ-T 0.3M	E2E-X3D28-M1TGJ-T 0.3M
M12 (7 mm)	Pre-wired (2 m) *2 *3	Yes	E2E-X7D112 2M	E2E-X7D212 2M
		No	E2E-X7D112-T 2M	E2E-X7D212-T 2M
	M12 Pre-wired Smartclick Connector (0.3 m) *4	Yes	E2E-X7D112-M1TGJ 0.3M	E2E-X7D212-M1TGJ 0.3M
		No	E2E-X7D112-M1TGJ-T 0.3M	E2E-X7D212-M1TGJ-T 0.3M
M18 (11 mm)	Pre-wired (2 m) *2 *3	Yes	E2E-X11D118 2M	E2E-X11D218 2M
		No	E2E-X11D118-T 2M	E2E-X11D218-T 2M
	M12 Pre-wired Smartclick Connector (0.3 m) *4	Yes	E2E-X11D118-M1TGJ 0.3M	E2E-X11D218-M1TGJ 0.3M
		No	E2E-X11D118-M1TGJ-T 0.3M	E2E-X11D218-M1TGJ-T 0.3M
M30 (20 mm)	Pre-wired (2 m) *2 *3	Yes	E2E-X20D130 2M	E2E-X20D230 2M
		No	E2E-X20D130-T 2M	E2E-X20D230-T 2M
	M12 Pre-wired Smartclick Connector (0.3 m) *4	Yes	E2E-X20D130-M1TGJ 0.3M	E2E-X20D230-M1TGJ 0.3M
		No	E2E-X20D130-M1TGJ-T 0.3M	E2E-X20D230-M1TGJ-T 0.3M

Unshielded Models

Size (Sensing distance)	Connection method	Polarity	Model	
			Operation mode: NO	Operation mode: NC
M8 (6 mm)	Pre-wired (2 m) *2 *3	Yes	E2E-X6MD18 2M	E2E-X6MD28 2M
		No	E2E-X6MD18-T 2M	E2E-X6MD28-T 2M
	M12 Pre-wired Smartclick Connector (0.3 m) *4	Yes	E2E-X6MD18-M1TGJ 0.3M	E2E-X6MD28-M1TGJ 0.3M
		No	E2E-X6MD18-M1TGJ-T 0.3M	E2E-X6MD28-M1TGJ-T 0.3M
M12 (10 mm)	Pre-wired (2 m) *2 *3	Yes	E2E-X10MD112 2M	E2E-X10MD212 2M
		No	E2E-X10MD112-T 2M	E2E-X10MD212-T 2M
	M12 Pre-wired Smartclick Connector (0.3 m) *4	Yes	E2E-X10MD112-M1TGJ 0.3M	E2E-X10MD212-M1TGJ 0.3M
		No	E2E-X10MD112-M1TGJ-T 0.3M	E2E-X10MD212-M1TGJ-T 0.3M
M18 (20 mm)	Pre-wired (2 m) *2 *3	Yes	E2E-X20MD1L18 2M	E2E-X20MD2L18 2M
		No	E2E-X20MD1L18-T 2M	E2E-X20MD2L18-T 2M
	M12 Pre-wired Smartclick Connector (0.3 m) *4	Yes	E2E-X20MD1L18-M1TGJ 0.3M	E2E-X20MD2L18-M1TGJ 0.3M
		No	E2E-X20MD1L18-M1TGJ-T 0.3M	E2E-X20MD2L18-M1TGJ-T 0.3M
M30 (40 mm)	Pre-wired (2 m) *2 *3	Yes	E2E-X40MD1L30 2M	E2E-X40MD2L30 2M
		No	E2E-X40MD1L30-T 2M	E2E-X40MD2L30-T 2M
	M12 Pre-wired Smartclick Connector (0.3 m) *4	Yes	E2E-X40MD1L30-M1TGJ 0.3M	E2E-X40MD2L30-M1TGJ 0.3M
		No	E2E-X40MD1L30-M1TGJ-T 0.3M	E2E-X40MD2L30-M1TGJ-T 0.3M

*1. When embedding the Proximity Sensor in metal, refer to *Influence of Surrounding Metal* on page 81.

*2. Models with 5-m cable length are also available with "5M" suffix. (Example: E2E-X3D18 5M)

*3. Models with 2-m and 5-m robot (bending-resistant) cables are also available with "-R" in the model number. (Example: E2E-X3D18-R 2M/E2E-X3D18-R 5M)

*4. Models with M12 Pre-wired Smartclick Connectors and robot (bending-resistant) cables are also available with "R" in the model number. (Example: E2E-X3D18-M1TGJR 0.3M/E2E-X3D18-M1TGJR-T 0.3M)

Sensors

E2EQ NEXT Series (Spatter-resistant Triple distance model)

DC 2-wire [Refer to Dimensions on page 84.]

Shielded Models *1

Size (Sensing distance)	Connection method	Polarity	Model	
			Operation mode: NO	Operation mode: NC
M8 (3 mm)	Pre-wired (2 m) *2	Yes	E2EQ-X3D18 2M	E2EQ-X3D28 2M
		No	E2EQ-X3D18-T 2M	E2EQ-X3D28-T 2M
	M12 Pre-wired Smartclick Connector (0.3 m)	Yes	E2EQ-X3D18-M1TGJ 0.3M	E2EQ-X3D28-M1TGJ 0.3M
		No	E2EQ-X3D18-M1TGJ-T 0.3M	E2EQ-X3D28-M1TGJ-T 0.3M
M12 (7 mm)	Pre-wired (2 m) *2	Yes	E2EQ-X7D112 2M	E2EQ-X7D212 2M
		No	E2EQ-X7D112-T 2M	E2EQ-X7D212-T 2M
	M12 Pre-wired Smartclick Connector (0.3 m)	Yes	E2EQ-X7D112-M1TGJ 0.3M	E2EQ-X7D212-M1TGJ 0.3M
		No	E2EQ-X7D112-M1TGJ-T 0.3M	E2EQ-X7D212-M1TGJ-T 0.3M
M18 (11 mm)	Pre-wired (2 m) *2	Yes	E2EQ-X11D118 2M	E2EQ-X11D218 2M
		No	E2EQ-X11D118-T 2M	E2EQ-X11D218-T 2M
	M12 Pre-wired Smartclick Connector (0.3 m)	Yes	E2EQ-X11D118-M1TGJ 0.3M	E2EQ-X11D218-M1TGJ 0.3M
		No	E2EQ-X11D118-M1TGJ-T 0.3M	E2EQ-X11D218-M1TGJ-T 0.3M
M30 (20 mm)	Pre-wired (2 m) *2	Yes	E2EQ-X20D130 2M	E2EQ-X20D230 2M
		No	E2EQ-X20D130-T 2M	E2EQ-X20D230-T 2M
	M12 Pre-wired Smartclick Connector (0.3 m)	Yes	E2EQ-X20D130-M1TGJ 0.3M	E2EQ-X20D230-M1TGJ 0.3M
		No	E2EQ-X20D130-M1TGJ-T 0.3M	E2EQ-X20D230-M1TGJ-T 0.3M

*1. When embedding the Proximity Sensor in metal, refer to *Influence of Surrounding Metal* on page 81.

*2. Models with 5-m cable length are also available with "5M" suffix. (Example: E2EQ-X3D18 5M)

E2E NEXT Series (Single distance model)

DC 2-wire [Refer to Dimensions on page 85.]

Shielded Models

Size (Sensing distance)	Connection method	Polarity	Model	
			Operation mode: NO	Operation mode: NC
M8 (1.5 mm)	Pre-wired (2 m) *2 *3	Yes	E2E-X1R5D1-N 2M	E2E-X1R5D2-N 2M
		No	E2E-X1R5D1-T-N 2M	E2E-X1R5D2-T-N 2M
	M12 Pre-wired Smartclick Connector (0.3 m) *4	Yes	E2E-X1R5D1-M1TGJ 0.3M	E2E-X1R5D2-M1TGJ 0.3M
		No	E2E-X1R5D1-M1TGJ-T 0.3M	E2E-X1R5D2-M1TGJ-T 0.3M
M12 (2.5 mm)	Pre-wired (2 m) *2 *3	Yes	E2E-X2R5D1-N 2M	E2E-X2R5D2-N 2M
		No	E2E-X2R5D1-T-N 2M	E2E-X2R5D2-T-N 2M
	M12 Pre-wired Smartclick Connector (0.3 m) *4	Yes	E2E-X2R5D1-M1TGJ 0.3M	E2E-X2R5D2-M1TGJ 0.3M
		No	E2E-X2R5D1-M1TGJ-T 0.3M	E2E-X2R5D2-M1TGJ-T 0.3M
M18 (5 mm)	Pre-wired (2 m) *2 *3	Yes	E2E-X5D1-N 2M	E2E-X5D2-N 2M
		No	E2E-X5D1-T-N 2M	E2E-X5D2-T-N 2M
	M12 Pre-wired Smartclick Connector (0.3 m) *4	Yes	E2E-X5D1-M1TGJ 0.3M	E2E-X5D2-M1TGJ 0.3M
		No	E2E-X5D1-M1TGJ-T 0.3M	E2E-X5D2-M1TGJ-T 0.3M

*1. Models with 5-m cable length are also available with "5M" suffix. (Example: E2E-X1R5D1-N 5M)

*2. Models with 2-m and 5-m robot (bending-resistant) cables are also available with "-R" in the model number. (Example: E2E-X1R5D1-R-N 2M/E2E-X1R5D1-R-N 5M)

*3. Models with M12 Smartclick connector model robot (bending-resistant) cables are also available with "R" in the model number. (Example: E2E-X1R5D1-M1TGJR 0.3M/E2E-X1R5D1-M1TGJR-T 0.3M)

E2E/E2EQ NEXT Series

Accessories (Sold Separately)



Sensor I/O Connectors

(Models for Pre-wired Connectors) A Sensor I/O Connector is not provided with the Sensor. It must be ordered separately as required.
Round Oil-resistant Connectors XS5 NEXT series

Appearance	Cable Specification	Type	Cable diameter (mm)	Cable Connection Direction	Cable length (m)	Sensor I/O Connector model number	Applicable Proximity Sensor model number
	Oil-resistant PVC cable	Sockets on One Cable End	6 dia.	Straight	1	XS5F-D421-C80-X	E2E-X□D□-M1TGJ(R)(-T) E2EQ-X□D□-M1TGJ(-T)
					2	XS5F-D421-D80-X	
					3	XS5F-D421-E80-X	
					5	XS5F-D421-G80-X	
					10	XS5F-D421-J80-X	
	Oil-resistant PVC robot cable	Sockets on One Cable End	6 dia.	Straight	1	XS5F-D421-C80-XR	
					2	XS5F-D421-D80-XR	
					3	XS5F-D421-E80-XR	
					5	XS5F-D421-G80-XR	
					10	XS5F-D421-J80-XR	
	Oil-resistant PVC cable	Socket and Plug on Cable Ends	6 dia.	Straight (Socket)/ Straight (Plug)	1	XS5W-D421-C81-X	
					2	XS5W-D421-D81-X	
					3	XS5W-D421-E81-X	
					5	XS5W-D421-G81-X	
					10	XS5W-D421-J81-X	
	Oil-resistant PVC robot cable	Socket and Plug on Cable Ends	6 dia.	Straight (Socket)/ Straight (Plug)	1	XS5W-D421-C81-XR	
					2	XS5W-D421-D81-XR	
					3	XS5W-D421-E81-XR	
5					XS5W-D421-G81-XR		
10					XS5W-D421-J81-XR		

Note: For details of the connector, refer to *XS5 NEXT Series* on page 87.

Round Water-resistant Connectors XS5 series

Appearance	Cable Specification	Type	Cable diameter (mm)	Cable Connection Direction	Cable length (m)	Sensor I/O Connector model number	Applicable Proximity Sensor model number
 	PVC robot cable	Sockets on One Cable End	6 dia.	Straight	1	XS5F-D421-C80-F	E2E-X□D□-M1TGJ(R)(-T) E2EQ-X□D□-M1TGJ(-T)
					2	XS5F-D421-D80-F	
					3	XS5F-D421-E80-F	
					5	XS5F-D421-G80-F	
					10	XS5F-D421-J80-F	
				Right-angle	1	XS5F-D422-C80-F	
					2	XS5F-D422-D80-F	
					3	XS5F-D422-E80-F	
					5	XS5F-D422-G80-F	
					10	XS5F-D422-J80-F	
	Oil-resistant PVC robot cable	Socket and Plug on Cable Ends	6 dia.	Straight (Socket)/ Straight (Plug)	1	XS5W-D421-C81-F	
					2	XS5W-D421-D81-F	
					3	XS5W-D421-E81-F	
					5	XS5W-D421-G81-F	
				Right-angle (Socket)/ Right-angle (Plug)	2	XS5W-D422-D81-F	
					5	XS5W-D422-G81-F	
				Straight (Socket)/ Right-angle (Plug)	2	XS5W-D423-D81-F	
					5	XS5W-D423-G81-F	
Right-angle (Socket)/ Straight (Plug)	2	XS5W-D424-D81-F					
	5	XS5W-D424-G81-F					

Note: For details of the connector, refer to *XS5 Series* on page 94.

Sensor I/O Connectors Oil resistance performance of mating combination

E2E NEXT Series Pre-wired Connector Models	Applicable connector Model	
	XS5 NEXT series	XS5 series
E2E-X□D□-M1TGJ(R)(-T)	2 years of oil resistance*	Water-resistant (IP67)

* Applicable cutting oil type: specified in JIS K 2241:2000
 2 years of oil resistance indicates the median value of the product design and the oil-resistance performance criterion result (=Typical value).
 Products to be shipped will have around 2 years of oil resistance, but will vary depending on the product.

e-jig (Mounting Sleeves) [Refer to Dimensions on page 86.]

A Mounting Bracket is not provided with the Sensor. It must be ordered separately as required.

Appearance	Model	Applicable Sensors
	Y92E-J8S12	E2E NEXT M8 Shielded Sensors
	Y92E-J12S18	E2E NEXT M12 Shielded Sensors
	Y92E-J18S30	E2E NEXT M18 Shielded Sensors

Note: Not applicable for E2EQ NEXT Series (spatter-resistant) models.

E2E/E2EQ NEXT Series

Ratings and Specifications

E2E NEXT Series (Triple distance model)

DC 2-wire

Item	Size		M8		M12		M18		M30						
	Shielded	Model	Shielded	Unshielded	Shielded	Unshielded	Shielded	Unshielded	Shielded	Unshielded					
			E2E-X3D□	E2E-X6MD□	E2E-X7D□	E2E-X10MD□	E2E-X11D□	E2E-X20MD□	E2E-X20D□	E2E-X40MD□					
Sensing distance			3 mm ±10%	6 mm ±10%	7 mm ±10%	10 mm ±10%	11 mm ±10%	20 mm ±10%	20 mm ±10%	40 mm ±10%					
Setting distance *1			0 to 2.4 mm	0 to 4.8 mm	0 to 5.6 mm	0 to 8 mm	0 to 8.8 mm	0 to 16 mm	0 to 16 mm	0 to 32 mm					
Differential travel			15% max. of sensing distance												
Detectable object			Ferrous metal (The sensing distance decreases with non-ferrous metal. Refer to <i>Engineering Data</i> on page 75.)												
Standard sensing object			Iron, 9 × 9 × 1 mm	Iron, 18 × 18 × 1 mm	Iron, 21 × 21 × 1 mm	Iron, 30 × 30 × 1 mm	Iron, 33 × 33 × 1 mm	Iron, 60 × 60 × 1 mm	Iron, 60 × 60 × 1 mm	Iron, 120 × 120 × 1 mm					
Response frequency *2			350 Hz	250 Hz	350 Hz	200 Hz	250 Hz	200 Hz	200 Hz	50 Hz					
Power supply voltage			10 to 30 VDC, (including 10% ripple (p-p))												
Leakage current			0.8 mA max.												
Control output	Load current	3 to 100 mA													
	Residual voltage	Polarity: 3 V max. (Load current: 100 mA, Cable length: 2 m) No polarity: 5 V max. (Load current: 100 mA, Cable length: 2 m)													
Indicator	D1 Models: Operation indicator (orange), Setting indicator (green) D2 Models: Operation indicator (orange)														
Operation mode	D1 Models: NO D2 Models: NC Refer to the timing charts under <i>I/O Circuit Diagrams</i> on page 78 for details.														
Protection circuits	Surge suppressor, Load short-circuit protection														
Ambient temperature range	Operating: -25 to 70°C, Storage: -40 to 85°C (with no icing or condensation)														
Ambient humidity range	Operating and Storage: 35% to 95% (with no condensation)														
Temperature influence			±10% max. of sensing distance at 23°C in the temperature range of -25 to 70°C				±20% max. of sensing distance at 23°C in the temperature range of -25 to 70°C		±10% max. of sensing distance at 23°C in the temperature range of -25 to 70°C		±20% max. of sensing distance at 23°C in the temperature range of -25 to 70°C				
Voltage influence			±1% max. of sensing distance at rated voltage in the rated voltage ±15% range												
Insulation resistance			50 MΩ min. (at 500 VDC) between current-carrying parts and case												
Dielectric strength			1,000 VAC, 50/60 Hz for 1 minute between current-carrying parts and case												
Vibration resistance (destruction)			10 to 55 Hz, 1.5-mm double amplitude for 2 hours each in X, Y, and Z directions												
Shock resistance (destruction)			500 m/s ² 10 times each in X, Y, and Z directions				1,000 m/s ² 10 times each in X, Y, and Z directions								
Degree of protection	Pre-wired Models/Pre-wired Connector Models: IP67 (IEC 60529), IP67G *3 (JIS C 0920 Annex 1) Passed OMRON's Oil-resistant Component Evaluation Standards *4 (Cutting oil type: specified in JIS K 2241:2000, Temperature: 35 °C max.) and ISO 20653 (old standard: DIN 40050 PART9) IP69K														
Connecting method	Pre-wired Models (Standard cable length: 2 m) and Pre-wired Connector Models (Standard cable length: 0.3 m)														
Weight (packed state)	Pre-wired Models	Approx. 60 g			Approx. 70 g			Approx. 130 g		Approx. 150 g		Approx. 180 g		Approx. 210 g	
	Pre-wired Connector Models	Approx. 30 g			Approx. 40 g			Approx. 70 g		Approx. 90 g		Approx. 110 g		Approx. 140 g	
Materials	Case	Nickel-plated brass		Stainless steel (SUS303)		Nickel-plated brass									
	Sensing surface	Polybutylene terephthalate (PBT)													
	Clamping nuts	Nickel-plated brass													
	Toothed washer	Zinc-plated iron													
Cable	Vinyl chloride (PVC)														
Accessories	Instruction manual, Clamping nuts, Toothed washer														

*1. Use the Sensor within the range in which the setting indicator (green LED) is ON (except D2 Models).

*2. The response frequency is an average value. Measurement conditions are as follows: standard sensing object, a distance of twice the standard sensing object, and a set distance of half the sensing distance.

*3. The IP67G is the degree of protection which is defined according to the JIS (Japanese Industrial Standards). The IP67 indicates the same level of protection as defined by the IEC, and the G indicates that a device has resistance to oil.

*4. The Oil-resistant Component Evaluation Standards are OMRON's own durability evaluation standards. 2-year oil resistance indicates the median value of the product design and the oil-resistance performance criterion result (=Typical value). The Pre-wired Connector Model verifies 2 years of oil resistance when mating with Round Oil-resistant Connectors XS5 NEXT series correctly. The degree of protection is not satisfied with the part where cable wires are uncovered for the Pre-wired Models.

E2EQ NEXT Series (Spatter-resistant Triple distance model)
DC 2-wire

Item	Size Shielded Model	M8	M12	M18	M30
		Shielded			
		E2EQ-X3D□	E2EQ-X7D□	E2EQ-X11D□	E2EQ-X20D□
Sensing distance		3 mm ±10%	7 mm ±10%	11 mm ±10%	20 mm ±10%
Setting distance *1		0 to 2.4 mm	0 to 5.6 mm	0 to 8.8 mm	0 to 16 mm
Differential travel		15% max. of sensing distance			
Detectable object		Ferrous metal (The sensing distance decreases with non-ferrous metal. Refer to <i>Engineering Data</i> on page 75.)			
Standard sensing object		Iron, 9 × 9 × 1 mm	Iron, 21 × 21 × 1 mm	Iron, 33 × 33 × 1 mm	Iron, 60 × 60 × 1 mm
Response frequency *2		250 Hz	250 Hz	250 Hz	200 Hz
Power supply voltage		10 to 30 VDC, (including 10% ripple (p-p))			
Leakage current		0.8 mA max.			
Control output	Load current	3 to 100 mA			
	Residual voltage	Polarity: 3 V max. (Load current: 100 mA, Cable length: 2 m) No polarity: 5 V max. (Load current: 100 mA, Cable length: 2 m)			
Indicator		D1 Models: Operation indicator (orange), Setting indicator (green) D2 Models: Operation indicator (orange)			
Operation mode		D1 Models: NO Refer to the timing charts under <i>I/O Circuit Diagrams</i> on page 78 for details. D2 Models: NC			
Protection circuits		Surge suppressor, Load short-circuit protection			
Ambient temperature range		Operating: -25 to 70°C, Storage: -40 to 85°C (with no icing or condensation)			
Ambient humidity range		Operating and Storage: 35% to 95% (with no condensation)			
Temperature influence		±10% max. of sensing distance at 23°C in the temperature range of -25 to 70°C		±20% max. of sensing distance at 23°C in the temperature range of -25 to 70°C	
Voltage influence		±1% max. of sensing distance at rated voltage in the rated voltage ±15% range			
Insulation resistance		50 MΩ min. (at 500 VDC) between current-carrying parts and case			
Dielectric strength		1,000 VAC, 50/60 Hz for 1 minute between current-carrying parts and case			
Vibration resistance (destruction)		10 to 55 Hz, 1.5-mm double amplitude for 2 hours each in X, Y, and Z directions			
Shock resistance (destruction)		500 m/s ² 10 times each in X, Y, and Z directions		1,000 m/s ² 10 times each in X, Y, and Z directions	
Degree of protection		Pre-wired Models/Pre-wired Connector Models: IP67 (IEC 60529) and IP67G *3 (JIS C 0920 Annex 1)			
Connecting method		Pre-wired Models (Standard cable length: 2 m) and Pre-wired Connector Models (Standard cable length: 0.3 m)			
Weight (packed state)	Pre-wired Models	Approx. 60 g	Approx. 70 g	Approx. 150 g	Approx. 210 g
	Pre-wired Connector Models	Approx. 30 g	Approx. 40 g	Approx. 90 g	Approx. 140 g
Materials	Case	Fluororesin coating (Base material: brass)			
	Sensing surface	Fluororesin			
	Clamping nuts	Fluororesin coating (Base material: brass)			
	Toothed washer	Zinc-plated iron			
	Cable	Vinyl chloride (PVC)			
Accessories		Instruction manual, Clamping nuts, Toothed washer			

*1. Use the Sensor within the range in which the setting indicator (green LED) is ON (except D2 Models).

*2. The response frequency is an average value. Measurement conditions are as follows: standard sensing object, a distance of twice the standard sensing object, and a set distance of half the sensing distance.

*3. The IP67G is the degree of protection which is defined according to the JIS (Japanese Industrial Standards).

The IP67 indicates the same level of protection as defined by the IEC, and the G indicates that a device has resistance to oil.

E2E/E2EQ NEXT Series

E2E NEXT Series (Single distance model) DC 2-wire

Item	Size Shielded Model	M8	M12	M18
		Shielded		
		E2E-X1R5D□	E2E-X2R5D□	E2E-X5D□
Sensing distance		1.5 mm ±10%	2.5 mm ±10%	5 mm ±10%
Setting distance *1		0 to 1.2 mm	0 to 2 mm	0 to 4 mm
Differential travel		10% max. of sensing distance		
Detectable object		Ferrous metal (The sensing distance decreases with non-ferrous metal. Refer to <i>Engineering Data</i> on page 75.)		
Standard sensing object		Iron, 10 × 10 × 1 mm	Iron, 12 × 12 × 1 mm	Iron, 18 × 18 × 1 mm
Response frequency *2		250 Hz	250 Hz	250 Hz
Power supply voltage		10 to 30 VDC, (including 10% ripple (p-p))		
Leakage current		0.8 mA max.		
Control output	Load current	3 to 100 mA		
	Residual voltage	Polarity: 3 V max. (Load current: 100 mA, Cable length: 2 m) No polarity: 5 V max. (Load current: 100 mA, Cable length: 2 m)		
Indicator		D1 Models: Operation indicator (orange), Setting indicator (green) D2 Models: Operation indicator (orange)		
Operation mode		D1 Models: NO Refer to the timing charts under <i>I/O Circuit Diagrams</i> on page 78 for details. D2 Models: NC		
Protection circuits		Surge suppressor, Load short-circuit protection		
Ambient temperature range		Operating: -25 to 70°C, Storage: -40 to 85°C (with no icing or condensation)		
Ambient humidity range		Operating and Storage: 35% to 95% (with no condensation)		
Temperature influence		±10% max. of sensing distance at 23°C in the temperature range of -25 to 70°C		
Voltage influence		±1% max. of sensing distance at rated voltage in the rated voltage ±15% range		
Insulation resistance		50 MΩ min. (at 500 VDC) between current-carrying parts and case		
Dielectric strength		1,000 VAC, 50/60 Hz for 1 minute between current-carrying parts and case		
Vibration resistance (destruction)		10 to 55 Hz, 1.5-mm double amplitude for 2 hours each in X, Y, and Z directions		
Shock resistance (destruction)		500 m/s ² 10 times each in X, Y, and Z directions	1,000 m/s ² 10 times each in X, Y, and Z directions	
Degree of protection		Pre-wired Models/Pre-wired Connector Models: IP67 (IEC 60529), IP67G *3 (JIS C 0920 Annex 1) Passed OMRON's Oil-resistant Component Evaluation Standards *4 (Cutting oil type: specified in JIS K 2241:2000, Temperature: 35°C max.) and ISO 20653 (old standard: DIN 40050 PART9) IP69K		
Connecting method		Pre-wired Models (Standard cable length: 2 m) and Pre-wired Connector Models (Standard cable length: 0.3 m)		
Weight (packed state)	Pre-wired Models	Approx. 60 g	Approx. 70 g	Approx. 130 g
	Pre-wired Connector Models	Approx. 30 g	Approx. 40 g	Approx. 70 g
Materials	Case	Stainless steel (SUS303)	Nickel-plated brass	
	Sensing surface	Polybutylene terephthalate (PBT)		
	Clamping nuts	Nickel-plated brass		
	Toothed washer	Zinc-plated iron		
	Cable	Vinyl chloride (PVC)		
Accessories		Instruction manual, Clamping nuts, Toothed washer		

*1. Use the Sensor within the range in which the setting indicator (green LED) is ON (except D2 Models).

*2. The response frequency is an average value. Measurement conditions are as follows: standard sensing object, a distance of twice the standard.

*3. The IP67G is the degree of protection which is defined according to the JIS (Japanese Industrial Standards).

The IP67 indicates the same level of protection as defined by the IEC, and the G indicates that a device has resistance to oil.

*4. The Oil-resistant Component Evaluation Standards are OMRON's own durability evaluation standards.

2-year oil resistance indicates the median value of the product design and the oil-resistance performance criterion result (=Typical value).

The Pre-wired Connector Model verifies 2 years of oil resistance when mating with Round Oil-resistant Connectors XS5 NEXT series correctly.

The degree of protection is not satisfied with the part where cable wires are uncovered for the Pre-wired Models.

Engineering Data (Reference Value)

Sensing Area

Triple distance model, Spatter-resistant Triple distance model

Shielded Models

E2E(Q)-X□D□

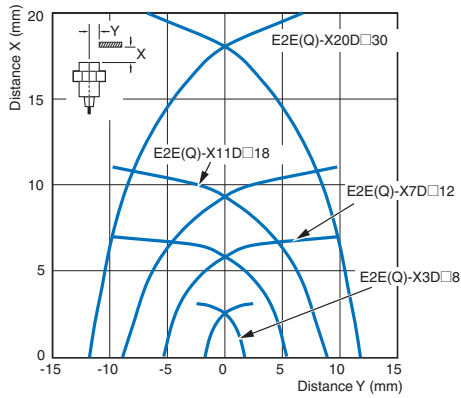

Unshielded Models

E2E-X□MD□

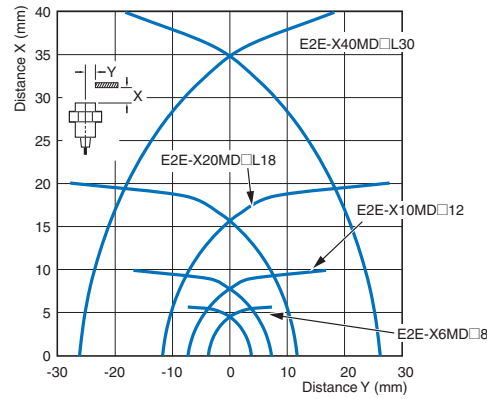

Single distance model

Shielded Models

E2E-X1R5D□/-X2R5D□/-X5D□

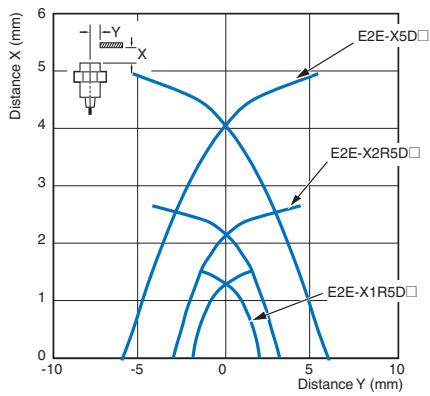

Influence of Sensing Object Size and Materials

Triple distance model, Spatter-resistant Triple distance model

Shielded Models

E2E(Q)-X3D□8

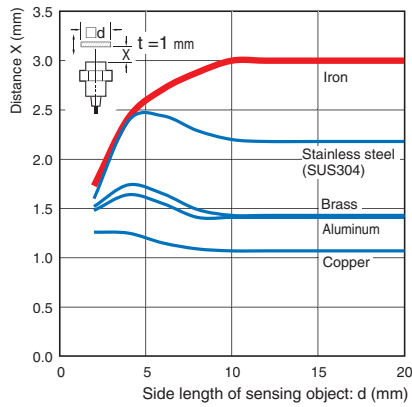

E2E(Q)-X7D□12

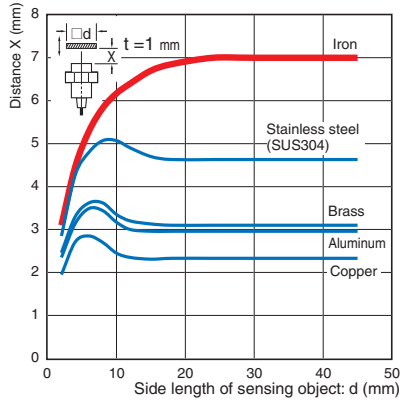

E2E(Q)-X11D□18

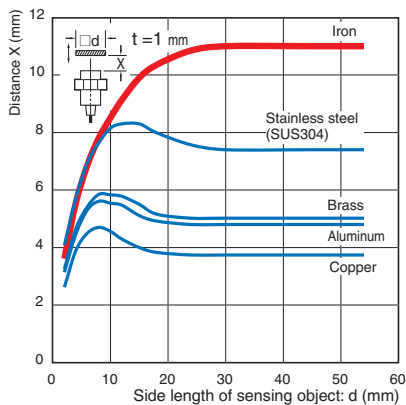

E2E(Q)-X20D□30

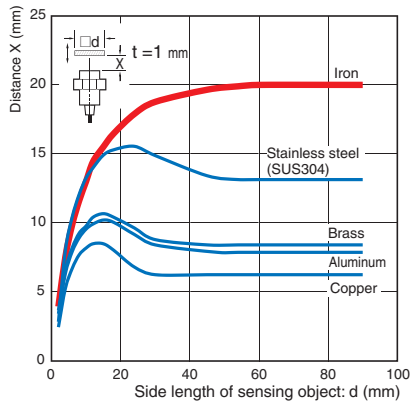

Unshielded Models

E2E-X6MD□8

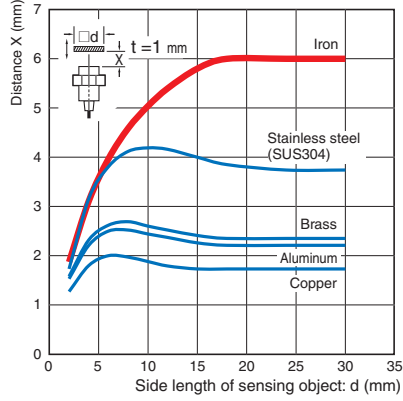

E2E-X10MD□12

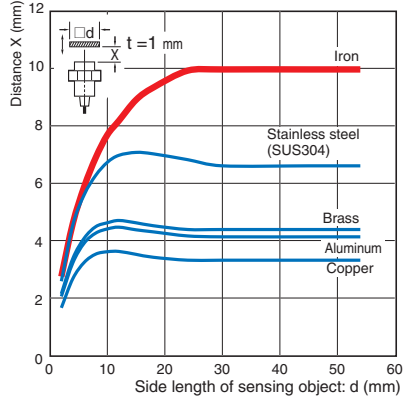

E2E-X20MD□L18

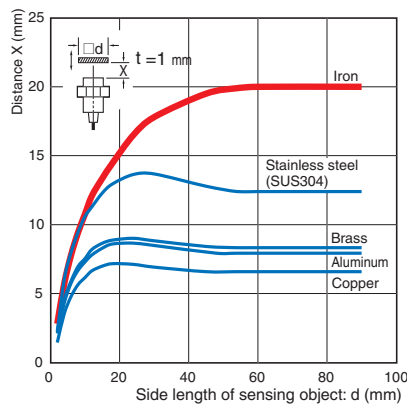

E2E-X40MD□L30

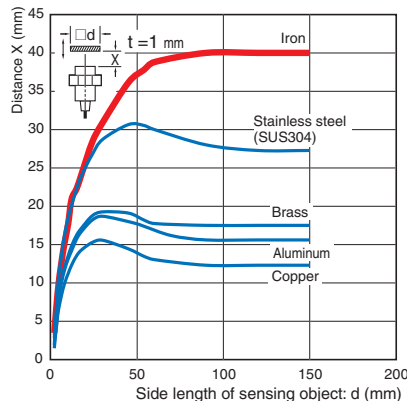

Single distance model

Shielded Models

E2E-X1R5D□

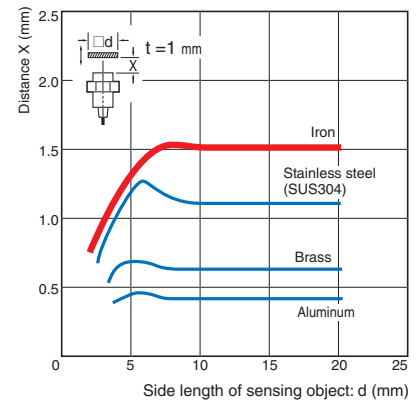

E2E-X2R5D□

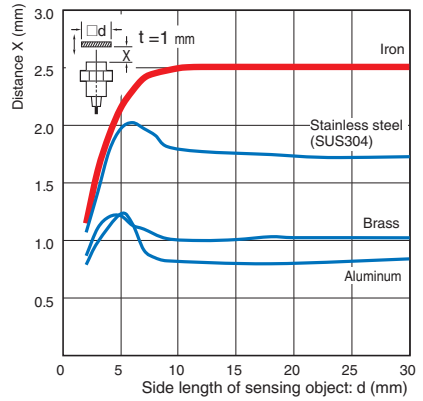

E2E-X5D□

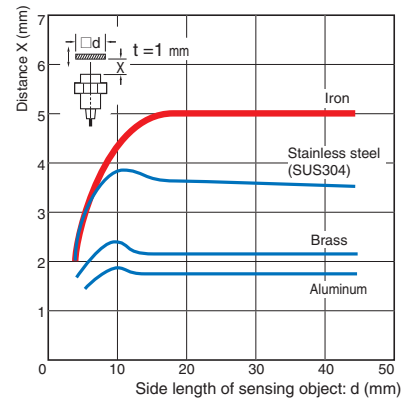

Leakage Current

Triple distance model, Spatter-resistant Triple distance model, Single distance model

E2E-X□(M)D□(-T)/E2EQ-X□D□(-T)

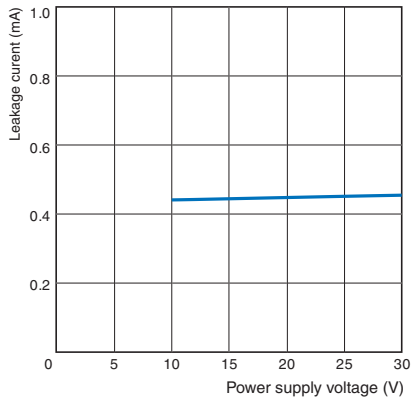

Residual Output Voltage

Triple distance model, Spatter-resistant Triple distance model, Single distance model

E2E-X□(M)D□(-T)/E2EQ-X□D□(-T)

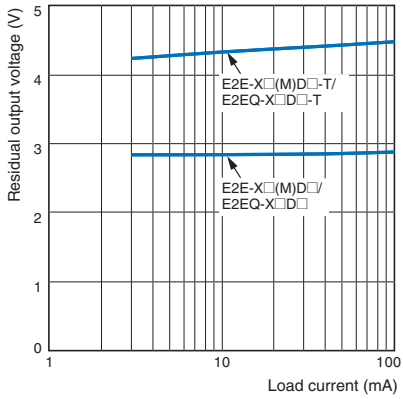

E2E/E2EQ NEXT Series

I/O Circuit Diagrams

DC 2-Wire Models

Operation mode	Model	Timing Chart	Output circuit
NO	E2E(Q)-X□D1□	<p>Non-sensing area Unstable sensing area Stable sensing area</p> <p>Sensing object</p> <p>(%) 100 80 0</p> <p>Proximity Sensor</p>	<p>Proximity sensor main circuit</p> <p>Brown ① Load 10 to 30 VDC</p> <p>Blue ④ 0 V</p> <p>Connector Pin Arrangement</p> <p>Note: Pins 2 and 3 are not used.</p>
	E2E(Q)-X□D1□-T	<p>Rated sensing distance</p> <p>ON Setting indicator (green)</p> <p>OFF</p> <p>ON Operation indicator (orange)</p> <p>OFF</p> <p>ON Control output</p> <p>OFF</p>	<p>Proximity sensor main circuit</p> <p>Brown ④ Load 10 to 30 VDC (0V)</p> <p>Blue ③ 0V (10 to 30 VDC)</p> <p>Connector Pin Arrangement</p> <p>Note: Pins 1 and 2 are not used.</p> <p>Note1. The load can be connected to either the +V or 0 V side. 2. The E2E□-X□D1□(-M1TGJ)-T has no polarity. There is no need to be concerned about the polarity of brown and blue wires, or pins 3 and 4.</p>
NC	E2E(Q)-X□D2□	<p>Non-sensing area Sensing area</p> <p>Sensing object</p> <p>(%) 100 0</p> <p>Proximity Sensor</p>	<p>Proximity sensor main circuit</p> <p>Brown ① Load 10 to 30 VDC</p> <p>Blue ② 0 V</p> <p>Connector Pin Arrangement</p> <p>Note: Pins 3 and 4 are not used.</p>
	E2E(Q)-X□D2□-T	<p>Rated sensing distance</p> <p>ON Operation indicator (orange)</p> <p>OFF</p> <p>ON Control output</p> <p>OFF</p>	<p>Proximity sensor main circuit</p> <p>Brown ① Load 10 to 30 VDC (0V)</p> <p>Blue ② 0V (10 to 30 VDC)</p> <p>Connector Pin Arrangement</p> <p>Note: Pins 3 and 4 are not used.</p> <p>Note1. The load can be connected to either the +V or 0 V side. 2. The E2E□-X□D1□(-M1TGJ)-T has no polarity. There is no need to be concerned about the polarity of brown and blue wires, or pins 1 and 2.</p>

Connections to Sensor I/O Connectors

Proximity Sensor				Sensor I/O Connector model number	Connections
Type	Polarity	Operation mode	Model		
DC 2-wire (Smartclick Connector)	Yes	NO	E2E-X□D1□-M1TGJ E2EQ-X□D1□-M1TGJ	XS5F-D421-□80-X□ XS5F-D42□-□80-F XS5W-D421-□81-X□ XS5W-D42□-□81-F Note: For details of the connector, refer to XS5 NEXT Series on page 87. XS5 Series on page 94.	E2E/E2EQ NEXT Series XS5
	No	NC	E2E-X□D2□-M1TGJ E2EQ-X□D2□-M1TGJ		E2E/E2EQ NEXT Series XS5
	Yes	NO	E2E-X□D1□-M1TGJ-T E2EQ-X□D1□-M1TGJ-T		E2E/E2EQ NEXT Series XS5F
	No	NC	E2E-X□D2□-M1TGJ-T E2EQ-X□D2□-M1TGJ-T		E2E/E2EQ NEXT Series XS5F

Note: Different from Proximity Sensor wire colors.

* If the XS5W Series Connector which has a socket and plug on the cable ends is connected to the Sensor, this part will be a plug.

E2E/E2EQ NEXT Series DC 3-wire

E2E/E2EQ NEXT Series DC 2-wire

XS5 NEXT Series

XS5

XS3



Safety Precautions



Be sure to read the precautions for all models in the website at: <http://www.ia.omron.com/>.

Warning Indications

⚠ WARNING	Warning level Indicates a potentially hazardous situation which, if not avoided, will result in minor or moderate injury, or may result in serious injury or death. Additionally there may be significant property damage.
Precautions for Safe Use	Supplementary comments on what to do or avoid doing, to use the product safely.
Precautions for Correct Use	Supplementary comments on what to do or avoid doing, to prevent failure to operate, malfunction or undesirable effect on product performance.

Meaning of Product Safety Symbols

	General prohibition Indicates the instructions of unspecified prohibited action.
	Caution, explosion Indicates the possibility of explosion under specific conditions.

⚠ WARNING
<p>This product is not designed or rated for ensuring safety of persons either directly or indirectly. Do not use it for such purposes.</p> <div style="text-align: right;"></div>
<p>Risk of explosion. Do not connect sensor to AC power supply.</p> <div style="text-align: right;"></div>

Precautions for Safe Use

The following precautions must be observed to ensure safe operation.

1. Do not use the product in an environment where flammable or explosive gas is present.
2. Do not attempt to disassemble, repair, or modify the product.
3. Do not use a voltage that exceeds the rated operating voltage range. Applying a voltage that is higher than the operating voltage range may result in damage or burnout.
4. Be sure that the power supply polarity and other wiring is correct. Incorrect wiring may cause explosion or burnout.
5. If the power supply is connected directly without a load, the internal elements may explode or burn. Be sure to insert a load when connecting the power supply.
6. Dispose of this product as industrial waste.

Precautions for Correct Use

Do not use this product under ambient conditions that exceed the ratings.

● Operating Environment

1. Do not install the product in the following locations. Doing so may result in product failure or malfunction.
 - (1) Outdoor locations directly subject to sunlight, rain, snow, water droplets, or oil.
 - (2) Locations subject to atmospheres with chemical vapors, in particular solvents and acids.
 - (3) Locations subject to corrosive gases.
2. The Sensor may malfunction if used near ultrasonic cleaning equipment, high-frequency equipment, transceivers, cellular phones, inverters, or other devices that generate a high-frequency electric field. Please refer to the Precautions for Correct Use on the OMRON website (www.ia.omron.com) for typical measures.
3. Laying the Proximity Sensor wiring in the same conduit or duct as high-voltage wires or power lines may result in incorrect operation and damage due to induction. Wire the Sensor using a separate conduit or independent conduit.
4. Never use thinner or other solvents. Otherwise, the Sensor surface may be dissolved.
5. The following conditions shall be observed if you use the product under an environment using cutting oil that may affect product's life and/or performance.
 - Usage under the cutting oil condition designated by the specification
 - Usage under the cutting oil dilution ratio recommended by its manufacturer
 - Usage in oil or water is prohibited

Impact on the product life may differ depending on the oil you use. Before using the cutting oil, make sure that it should not cause deterioration or degradation of sealing components.

● Design

Influence of Surrounding Metal

When mounting the Proximity Sensor using a nut, only use the provided nut. And ensure that the minimum distances given in the following table are maintained.

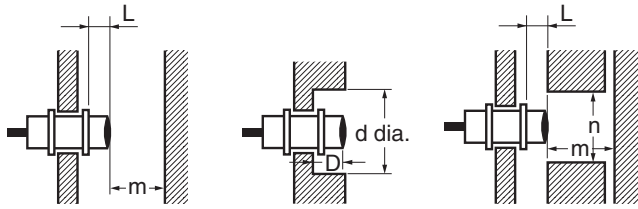

(Unit: mm)

Type	Item	M8	M12	M18	M30
Triple distance model/ Spatter-resistant Triple distance model E2E(Q)-X□D□(-T) *1	L	0	0	0	0
	d	20	20	50	70
	D	2	4	4	8
	m	9	18	33	60
	n	18	20	54	90
Triple distance model E2E-X□MD□(-T) *2	L	10	16	31	50 *3
	d	30	50	90	170
	D	13	20	35	55
	m	18	30	60	120
Single distance model E2E-X□R5D□(-T) E2E-X5D□(-T) *2	L	0	0	0	---
	d	8	12	18	
	D	0	0	0	
	m	4.5	8	20	
	n	12	18	27	

Note: Nuts that are supplied along with each Sensor (*1, *2) are different. Refer to *Dimensions* for details on shapes.

*3. If you use the M30 Triple distance model of Unshielded Model, the panel thickness (t) is 4 mm or less.

When the Proximity Sensor is mounted in metal, ensure that the minimum distances given in the following table are maintained.

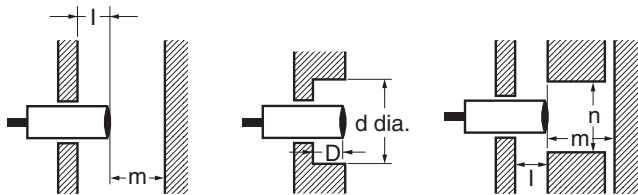

(Unit: mm)

Type	Item	M8	M12	M18	M30
Triple distance model/ Spatter-resistant Triple distance model E2E(Q)-X□D□(-T)	l	2	4	4	8
	d	20	20	50	70
	D	2	4	4	8
	m	9	18	33	60
Triple distance model E2E-X□MD□(-T)	l	13	20	35	55
	d	30	50	90	170
	D	13	20	35	55
	m	18	30	60	120
	n	30	50	80	140
	l	0	0	0	---
	d	8	12	18	
	D	0	0	0	
m	4.5	8	20		
	n	12	18	27	

● Mutual Interference

When the Proximity Sensor is embedded in metal, ensure that the minimum distances given in the following table are maintained.

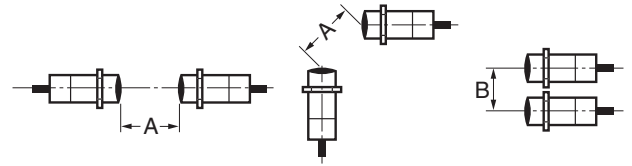

(Unit: mm)

Type	Item	M8	M12	M18	M30
Triple distance model/ Spatter-resistant Triple distance model E2E(Q)-X□D□(-T)	Shielded A	25	40	70	140
	Shielded B	20	30	45	70
Triple distance model E2E-X□MD□(-T)	Unshielded A	80	120	200	380
	Unshielded B	60	100	120	280
Single distance model E2E-X□R5D□(-T) E2E-X5D□(-T)	Shielded A	20	30	50	---
	Shielded B	15	20	35	---

● Mounting

Tightening Force

Do not tighten the nut with excessive force. A washer must be used with the nut.

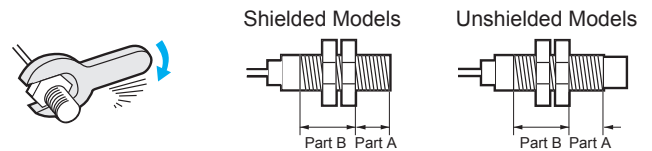

Note: 1. The allowable tightening strength depends on the distance from the edge of the head, as shown in the following table. (A is the distance from the edge of the head. B includes the nut on the head side. If the edge of the nut is in part A, the tightening torque for part A applies instead.)
2. The following strengths assume washers are being used.

Triple distance model

Model		Part A		Part B
		Dimension (mm)	Torque	Torque
M8	Shielded	9	4 N·m	10 N·m
	Unshielded	3		
M12	Shielded	16	6 N·m	15 N·m
	Unshielded	9		
M18	Shielded	16	15 N·m	60 N·m
	Unshielded	3		
M30	Shielded	23	40 N·m	80 N·m
	Unshielded	8		

Spatter-resistant Triple distance model

Model	Part A		Part B
	Dimension (mm)	Torque	Torque
M8	9	4 N·m	10 N·m
M12	16	6 N·m	15 N·m
M18	16	15 N·m	30 N·m
M30	23	40 N·m	80 N·m

Single distance model

Model	Part A		Part B
	Dimension (mm)	Torque	Torque
M8	9	9 N·m	12 N·m
M12	---	30 N·m	
M18	---	70 N·m	

E2E/E2EQ NEXT Series

Dimensions

(Unit: mm)
Tolerance class IT16 applies to dimensions in this data sheet unless otherwise specified.

Sensors

E2E NEXT Series (Triple distance model) DC 2-wire

Pre-wired Models Shielded



E2E-X3D□8

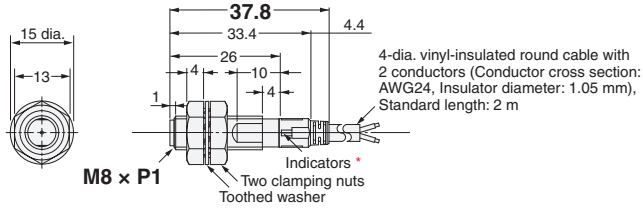

* D1 Models: Operation indicator (Orange), Setting indicator (Green)
D2 Models: Operation indicator (Orange)

Pre-wired Models Unshielded



E2E-X6MD□8

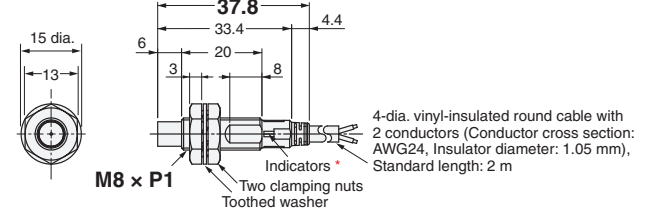

* D1 Models: Operation indicator (Orange), Setting indicator (Green)
D2 Models: Operation indicator (Orange)

E2E-X7D□12

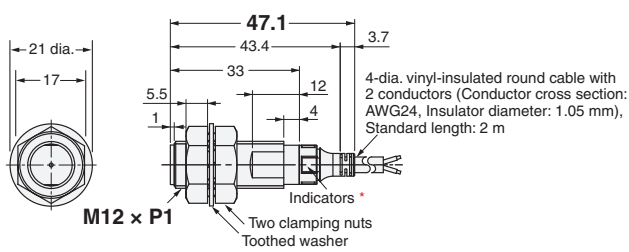

* D1 Models: Operation indicator (Orange), Setting indicator (Green)
D2 Models: Operation indicator (Orange)

E2E-X10MD□12

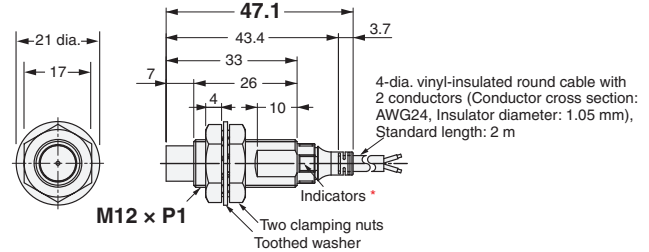

* D1 Models: Operation indicator (Orange), Setting indicator (Green)
D2 Models: Operation indicator (Orange)

E2E-X11D□18

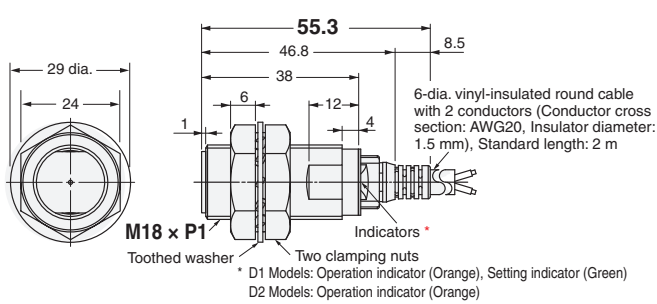

* D1 Models: Operation indicator (Orange), Setting indicator (Green)
D2 Models: Operation indicator (Orange)

E2E-X20MD□18

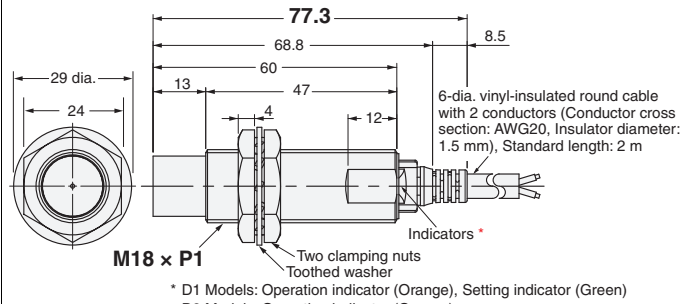

* D1 Models: Operation indicator (Orange), Setting indicator (Green)
D2 Models: Operation indicator (Orange)

E2E-X20D□30

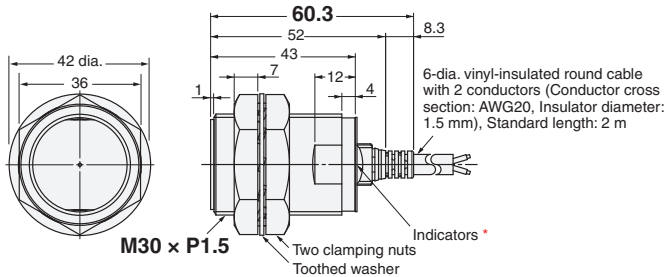

* D1 Models: Operation indicator (Orange), Setting indicator (Green)
D2 Models: Operation indicator (Orange)

E2E-X40MD□L30

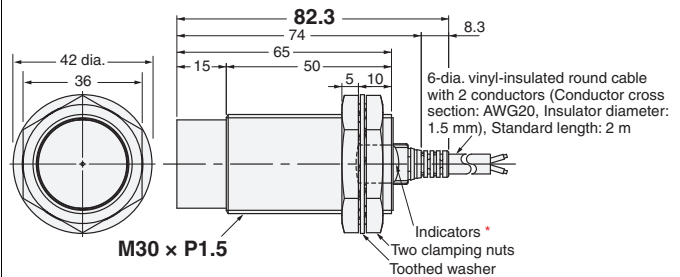

* D1 Models: Operation indicator (Orange), Setting indicator (Green)
D2 Models: Operation indicator (Orange)

Mounting Hole Dimensions

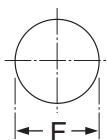

Dimensions	F (mm)
M8	8.5 dia. $+0.5_0$
M12	12.5 dia. $+0.5_0$
M18	18.5 dia. $+0.5_0$
M30	30.5 dia. $+0.5_0$

Angle R of the Bending Wire

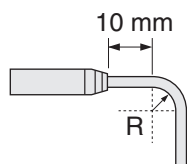

Dimensions	R (mm)
M8	12
M12	
M18	18
M30	

Wire pullout position

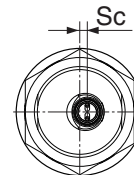

Dimensions	Sc (mm)
M8	- (0)
M12	
M18	2.5
M30	

Pre-wired Connector Models Shielded



E2E-X3D□8-M1TGJ

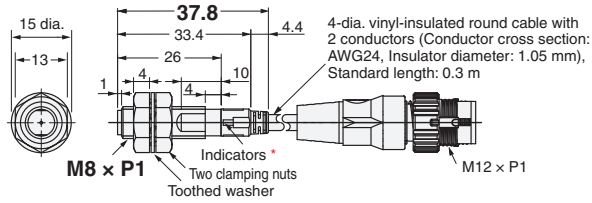

* D1 Models: Operation indicator (Orange), Setting indicator (Green)
D2 Models: Operation indicator (Orange)

Pre-wired Connector Models Unshielded



E2E-X6MD□8-M1TGJ

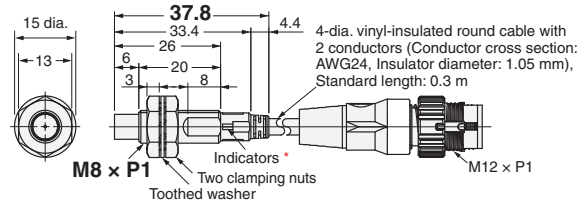

* D1 Models: Operation indicator (Orange), Setting indicator (Green)
D2 Models: Operation indicator (Orange)

E2E-X7D□12-M1TGJ

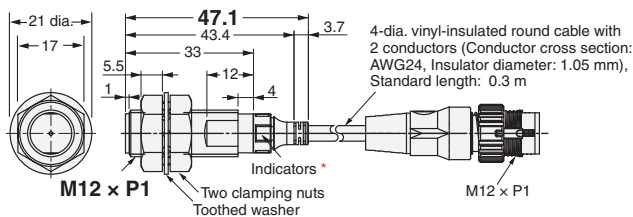

* D1 Models: Operation indicator (Orange), Setting indicator (Green)
D2 Models: Operation indicator (Orange)

E2E-X10MD□12-M1TGJ

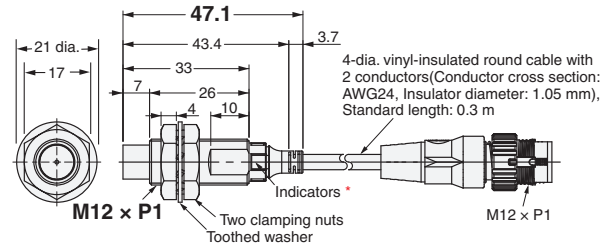

* D1 Models: Operation indicator (Orange), Setting indicator (Green)
D2 Models: Operation indicator (Orange)

E2E-X11D□18-M1TGJ

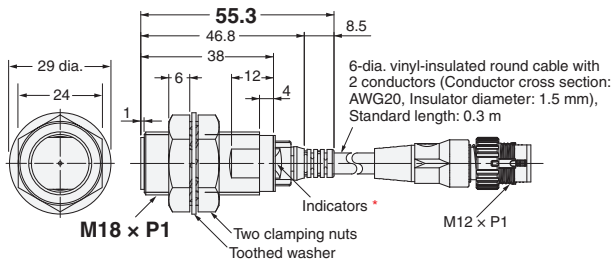

* D1 Models: Operation indicator (Orange), Setting indicator (Green)
D2 Models: Operation indicator (Orange)

E2E-X20MD□L18-M1TGJ

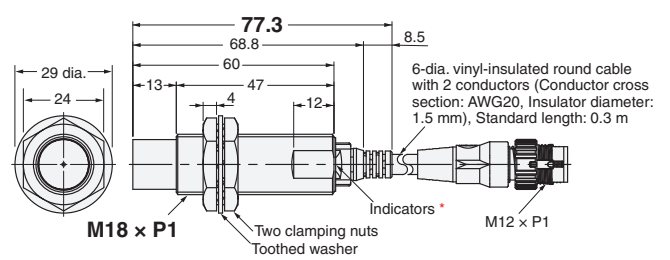

* D1 Models: Operation indicator (Orange), Setting indicator (Green)
D2 Models: Operation indicator (Orange)

E2E-X20D□30-M1TGJ

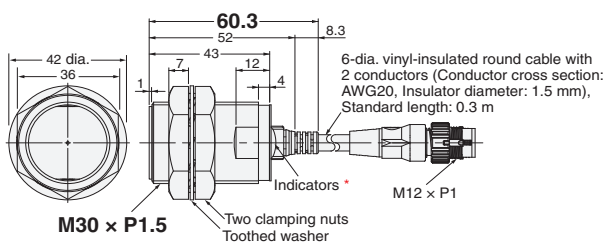

* D1 Models: Operation indicator (Orange), Setting indicator (Green)
D2 Models: Operation indicator (Orange)

E2E-X40MD□L30-M1TGJ

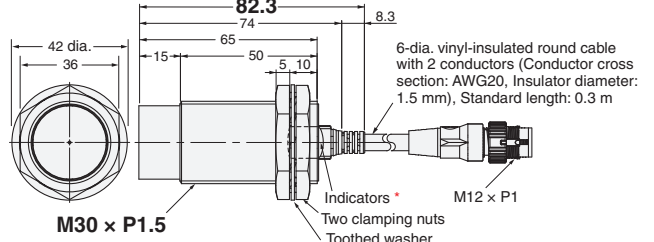

* D1 Models: Operation indicator (Orange), Setting indicator (Green)
D2 Models: Operation indicator (Orange)

Mounting Hole Dimensions

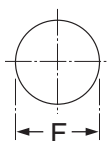

Dimensions	F (mm)
M8	8.5 dia. ^{+0.5} / ₀
M12	12.5 dia. ^{+0.5} / ₀
M18	18.5 dia. ^{+0.5} / ₀
M30	30.5 dia. ^{+0.5} / ₀

Angle R of the Bending Wire

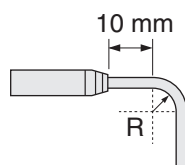

Dimensions	R (mm)
M8	12
M12	12
M18	18
M30	18

Wire pullout position

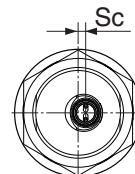

Dimensions	Sc (mm)
M8	- (0)
M12	- (0)
M18	2.5
M30	2.5

E2E/E2EQ NEXT Series

Sensors

E2EQ NEXT Series (Spatter-resistant Triple distance model)

DC 2-wire

Pre-wired Models Shielded



E2EQ-X3D□8

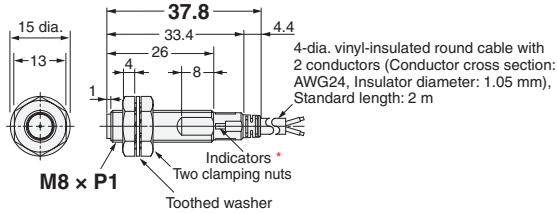

* D1 Models: Operation indicator (Orange), Setting indicator (Green)
D2 Models: Operation indicator (Orange)

E2EQ-X7D□12

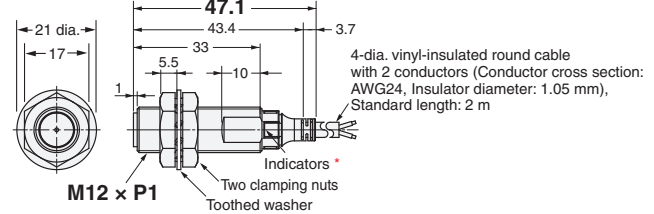

* D1 Models: Operation indicator (Orange), Setting indicator (Green)
D2 Models: Operation indicator (Orange)

E2EQ-X11D□18

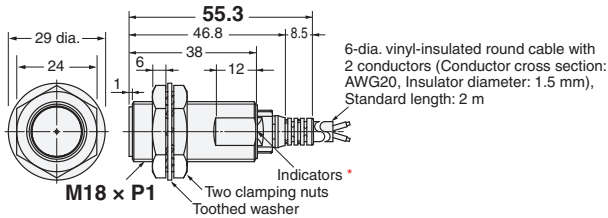

* D1 Models: Operation indicator (Orange), Setting indicator (Green)
D2 Models: Operation indicator (Orange)

E2EQ-X20D□30

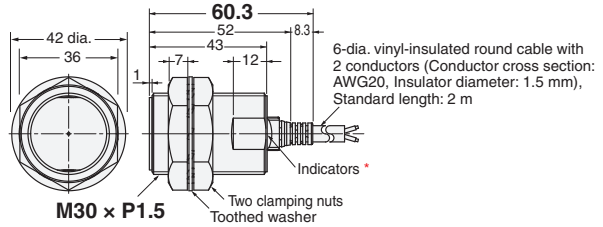

* D1 Models: Operation indicator (Orange), Setting indicator (Green)
D2 Models: Operation indicator (Orange)

Pre-wired Connector Models Shielded



E2EQ-X3D□8-M1TGJ

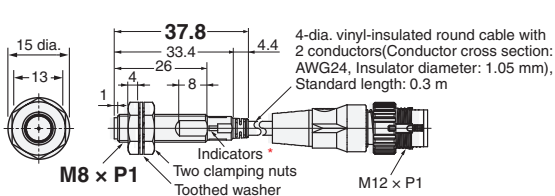

* D1 Models: Operation indicator (Orange), Setting indicator (Green)
D2 Models: Operation indicator (Orange)

E2EQ-X7D□12-M1TGJ

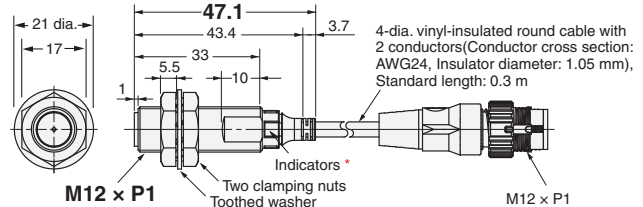

* D1 Models: Operation indicator (Orange), Setting indicator (Green)
D2 Models: Operation indicator (Orange)

E2EQ-X11D□18-M1TGJ

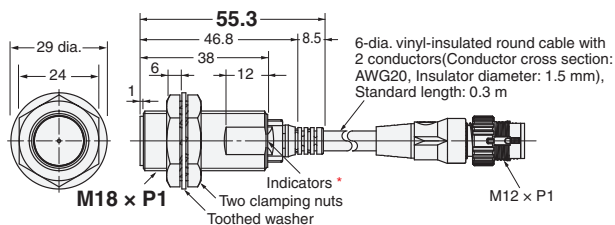

* D1 Models: Operation indicator (Orange), Setting indicator (Green)
D2 Models: Operation indicator (Orange)

E2EQ-X20D□30-M1TGJ

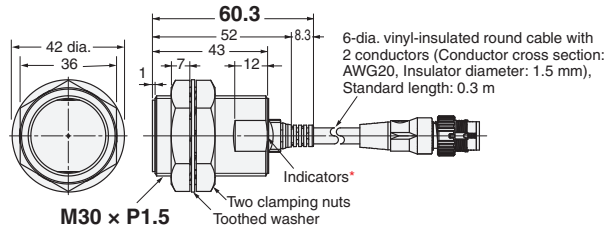

* D1 Models: Operation indicator (Orange), Setting indicator (Green)
D2 Models: Operation indicator (Orange)

Mounting Hole Dimensions

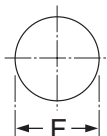

Dimensions	F (mm)
M8	8.5 dia. $+0.5_0$
M12	12.5 dia. $+0.5_0$
M18	18.5 dia. $+0.5_0$
M30	30.5 dia. $+0.5_0$

Angle R of the Bending Wire

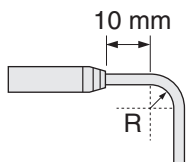

Dimensions	R (mm)
M8	12
M12	12
M18	18
M30	18

Wire pullout position

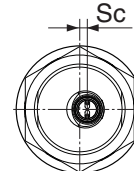

Dimensions	Sc (mm)
M8	- (0)
M12	- (0)
M18	2.5
M30	2.5

Sensors

E2E NEXT Series (Single distance model)

DC 2-wire

Pre-wired Models
Shielded



E2E-X1R5D

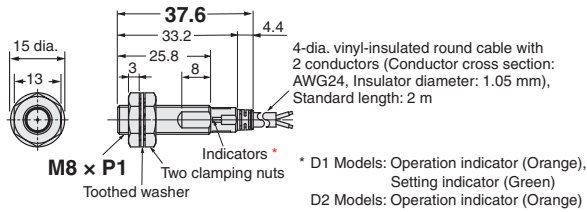

E2E-X2R5D

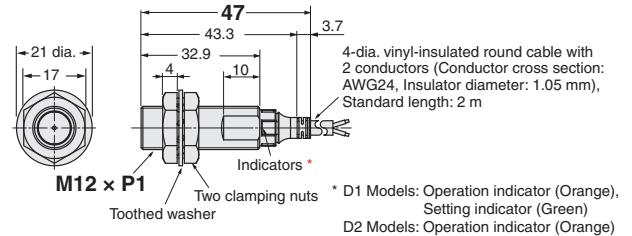

E2E-X5D

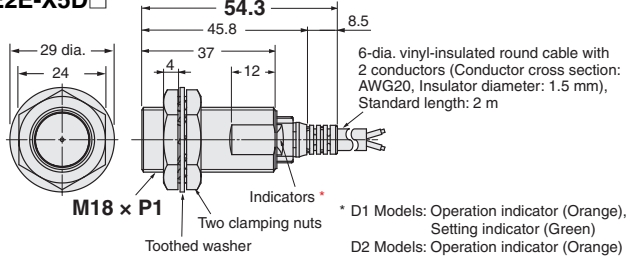

Pre-wired Connector Models
Shielded



E2E-X1R5D-M1TGJ

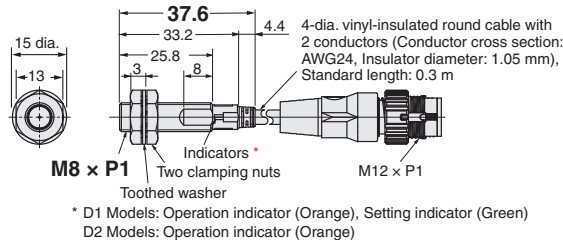

E2E-X2R5D-M1TGJ

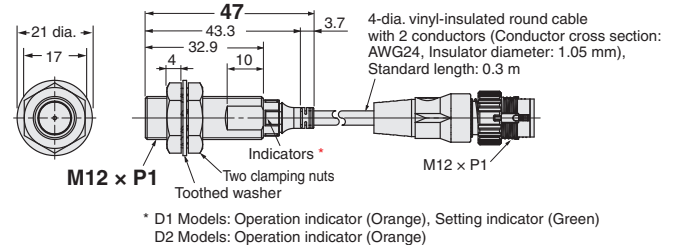

E2E-X5D-M1TGJ

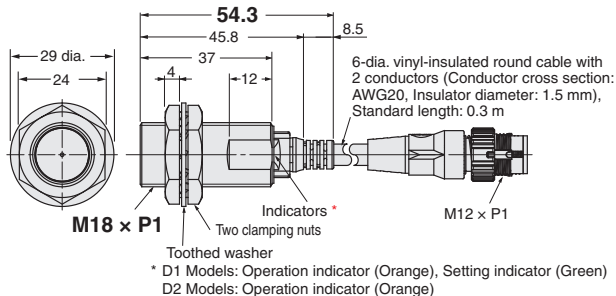

Mounting Hole Dimensions

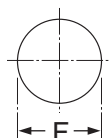

Dimensions	F (mm)
M8	8.5 dia. ^{+0.5} / ₀
M12	12.5 dia. ^{+0.5} / ₀
M18	18.5 dia. ^{+0.5} / ₀
M30	30.5 dia. ^{+0.5} / ₀

Angle R of the Bending Wire

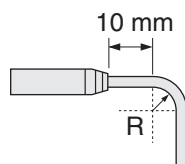

Dimensions	R (mm)
M8	12
M12	12
M18	18
M30	18

Wire pullout position

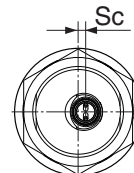

Dimensions	Sc (mm)
M8	- (0)
M12	- (0)
M18	2.5
M30	2.5

Accessories (Sold Separately)

e-jig (Mounting Sleeves)

Y92E-J8S12

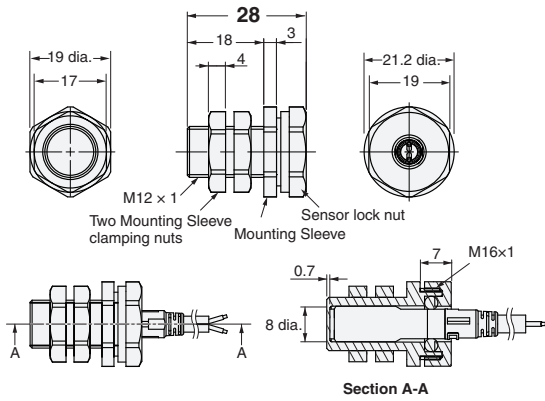

Y92E-J12S18

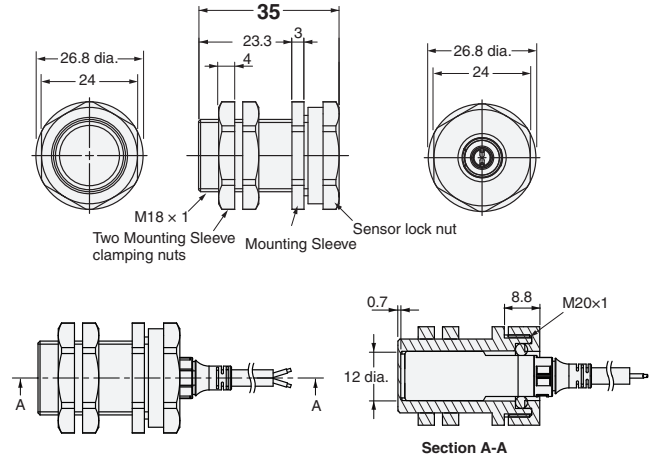

Y92E-J18S30

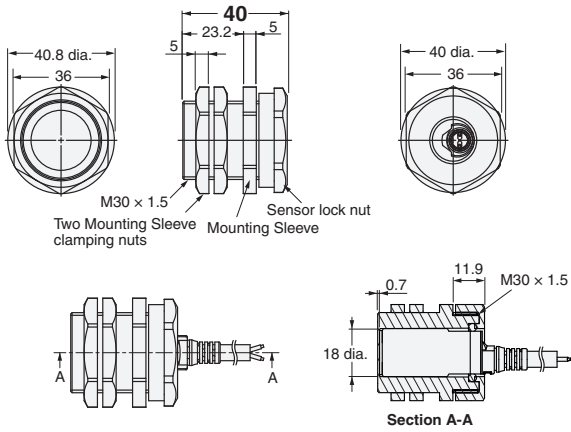

Material

Mounting Sleeve	Polyetheretherketone (PEEK) / Polybutylene terephthalate (PBT)
Mounting Sleeve clamping nut	Polybutylene terephthalate (PBT)
Sensor lock nut	Polybutylene terephthalate (PBT)
Sensor lock O-ring	Material combining HNBR and fluororubber

Tightening Force

Model	Torque	
	Mounting Sleeve clamping nut	Sensor lock nut
Y92E-J8S12	0.6 N·m	0.6 N·m
Y92E-J12S18	1.2 N·m	1.2 N·m
Y92E-J18S30	5 N·m	3.5 N·m

XS5 NEXT Series

Round Oil-resistive Smartclick Connectors for E2E NEXT Series proximity sensors, that are Resistant to Oil, and that Reduce Installation Work

- Uses unique OMRON technology*1 and the same PVC cable with increased oil resistance as the E2E NEXT Series proximity sensors. Oil-resistance performance values of 2 years*2 when used in combination with E2E NEXT Series proximity sensors.
- Oil-resistant robot cables for use with moving parts such as loaders and cableveyors **NEW**
- OMRON's unique lock mechanism (Smartclick) that is compatible with round M12 connectors.
- Simply insert the Connectors, then turn them approximately 1/8 of a turn to lock.
- A positive click indicates locking.
- IP67, IP69K degree of protection.
- UL approved products.

*1. Patent pending (as of July, 2018)

*2. Covered types of oil: Cutting oil specified in JIS K 2241:2000

The oil-resistance performance value (2 years) indicates the median value (=Typ) at product design, and in evaluation testing results of oil-resistance performance. Shipped products will show some variance around this 2 year value in actual usage.



Smartclick

For the most recent information on models that have been certified for safety standards, refer to your OMRON website.

Features

Better Cable Oil Resistance, and Improved Overall Oil Resistance with New Rubber Material in Mating Sections

The XS5 NEXT Series uses a special PVC cable that limits deterioration of the cable sheath due to both water-soluble and water-insoluble cutting oil. Omron's proprietary molding technique prevents cutting oil intrusion from mating sections. Moreover, using the same new HNBR/fluoride rubber as in oil-resistant components of connector mating sections helps improve the overall oil resistance.

Special PVC Cable + Molding Sealing Method

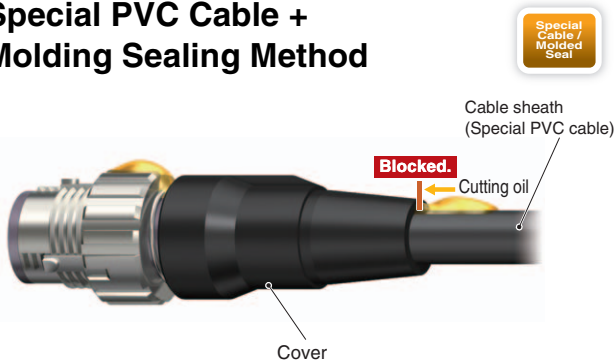

Smartclick Structure + O-ring

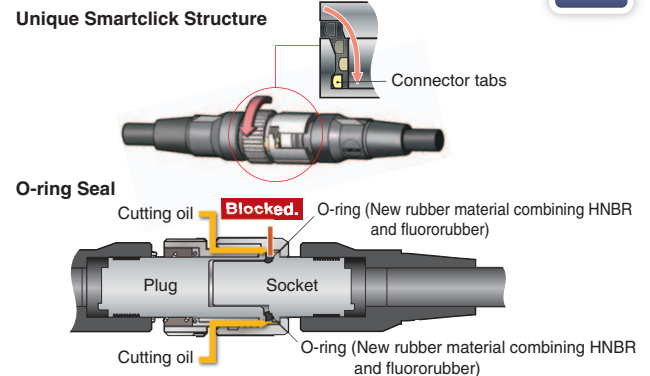

Patented

New Rubber Material Combining and Fluororubber

Hydrogenated nitrile butadiene rubber (HNBR), which provides superior resistance to oil, was blended with fluororubber in a unique OMRON compound to develop a new rubber that provides superior resistance to both swelling and deterioration due to cutting oil. It is used in seals for joints and moving sections that prevent ingress to prevent deterioration and destruction of the seal due to cutting oil, resulting in increased oil resistance performance.

This new material combines the benefits of HNBR and fluororubber

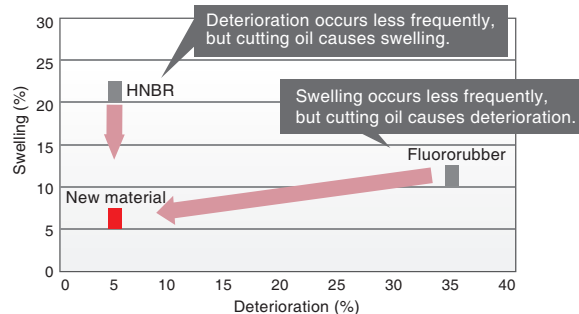

P67G quality and Omron's Oil Resistance Component Evaluation System for two years of proven oil resistant capability

Oil resistance: **2 years***

IP67G	
Oil type	N3 (water-insoluble cutting oil)
Evaluation time	48 hours
Evaluation temperature	Room temperature
Dilution concentration	---
Criteria	Appearance and performance



(Illustration)

OMRON's Oil-resistant Component Evaluation Standards	
Oil type	A1 (water-soluble cutting oil)
Evaluation time	1,000 hours of machining
Evaluation temperature	55 °C
Dilution concentration	Undiluted
Criteria	Appearance, performance, and no label text loss



(Illustration)

* Applicable oil types: specified in JIS K 2241:2000

"2-year oil resistance" refers to median values (=Typical values) of the product designs and the oil-resistance performance evaluation results. Products to be shipped will have around 2 years of oil resistance; actual oil resistance will vary depending on the product.

Varied product lineup to suit the application

Fixed Parts XS5□-D421-□8□-X

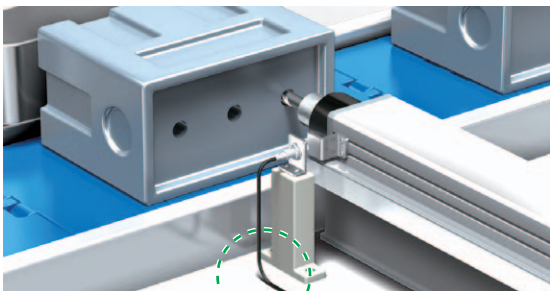

Fixed installation

Moving Parts XS5□-D421-□8□-XR **NEW**

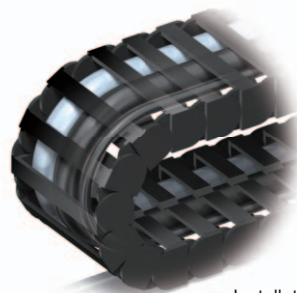

Installation with moving parts such as loaders and cableveyors

Model Number Structure

Model Number Legend

Use this legend when determining the product specifications from the model number. When ordering, use a model number from the table in **Ordering Information**.

XS5 □ - **D** 4 2 1 - □ **8** □ - **X** □

1 2 3 4 5 6 7 8 9

1. Type

W: Connectors connected to cable, socket and plug on cable ends
F: Connectors connected to cable, socket on one cable end

2. Mating Section Form

D: A-coding (for DC sensor)

3. Connector Poles

4: 4 poles

4. Contact Plating

2: Gold plating

5. Cable Connection Direction

XS5W 1: Straight (Socket)/Straight (Plug)

XS5F 1: Straight

6. Cable Length

C: 1 m

D: 2 m

E: 3 m

G: 5 m

J: 10 m

7. Connections (Numbers inside circles are terminal numbers)

8: A Brown, B White, C Blue, D Black

8. Connectors on One End/Both Ends

0: Sockets on One Cable End

1: Socket and Plug on Cable Ends

9. Cable Specifications

X: Oil-resistant PVC cable

XR: Oil-resistant PVC robot cable

Ordering Information

Connectors

Type	Cable outer diameter (mm)	Cable specifications	Cable length (m)	Model	UL
Socket and Plug on Cable Ends	6 dia.	Oil-resistant PVC cable	1	XS5W-D421-C81-X	UL2238 certified (File no. E207683)
			2	XS5W-D421-D81-X	
			3	XS5W-D421-E81-X	
			5	XS5W-D421-G81-X	
			10	XS5W-D421-J81-X	
	6 dia.	Oil-resistant PVC robot cable	1	XS5W-D421-C81-XR	
			2	XS5W-D421-D81-XR	
			3	XS5W-D421-E81-XR	
			5	XS5W-D421-G81-XR	
			10	XS5W-D421-J81-XR	
Sockets on One Cable End	6 dia.	Oil-resistant PVC cable	1	XS5F-D421-C80-X	
			2	XS5F-D421-D80-X	
			3	XS5F-D421-E80-X	
			5	XS5F-D421-G80-X	
			10	XS5F-D421-J80-X	
	6 dia.	Oil-resistant PVC robot cable	1	XS5F-D421-C80-XR	
			2	XS5F-D421-D80-XR	
			3	XS5F-D421-E80-XR	
			5	XS5F-D421-G80-XR	
			10	XS5F-D421-J80-XR	

Accessories (Sold Separately)

Connector Covers

Water-resistant Covers

Model	Material	Suitable connector		Remarks
		Model	Mounting portion	
XS2Z-11	Brass/nickel plated	XS5W	M12 male screw	This provides IP67 levels of protection. When mounting the Water-resistant Cover to a Connector, be sure to apply a torque range between 0.39 and 0.49 N·m to tighten the Water-resistant Cover.
XS5Z-11	PBT	XS5F/XS5W	M12 female screw	This provides IP67 levels of protection. This uses the Smart click mechanism. There's no need to keep track of locking torque.

Water-resistant Covers

XS2Z-11

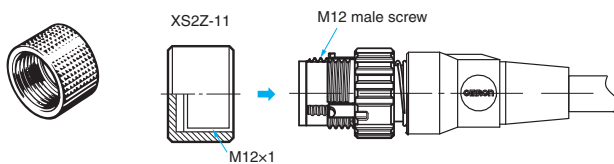

XS5Z-11

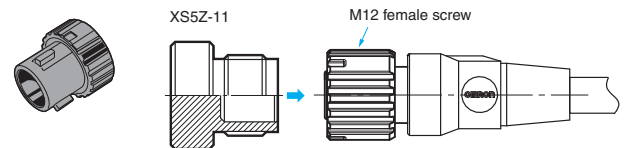

Dust Covers

Model	Material	Suitable connector		Remarks
		Model	Mounting portion	
XS2Z-13	Rubber/black	XS5W	M12 male screw	The Dust Cover is for dust prevention and does not ensure IP67 degree of protection. When mounting the Dust Cover to a connector, be sure to press the Dust Cover onto the Connector until the Connector is fully inserted into the Dust Cover.
XS2Z-14		XS5F/XS5W	Contact blocks (female contact)	
XS2Z-15			M12 female screw	

Dust Covers

XS2Z-13

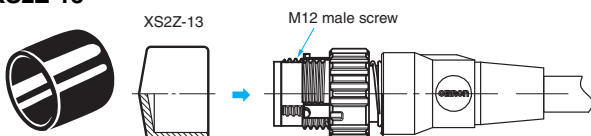

XS2Z-15/XS2Z-14

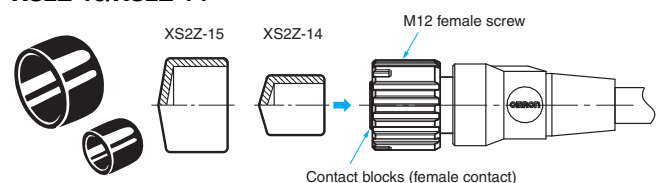

XS5 NEXT Series

Ratings and Specifications

Rated current	4 A
Rated voltage	250 VDC
Contact resistance (connector)	40 mΩ max. (at 20 mV max., 100 mA max.)
Insulation resistance	1,000 MΩ min. (at 500 VDC) *1
Dielectric strength (connector)	1,500 VAC for 1 minute (leakage current: 1 mA max.)
Degree of protection	IP67 (IEC60529) IP69K (ISO20653 (formerly DIN Standard 40050 PART9)) OMRON's Oil-resistant Component Evaluation Standards *2 (Cutting oil type JIS K 2241:2000-specification cutting oil, at 35°C or below)
Insertion tolerance	50 times
Lock strength	Tensile: 100 N/15 s, Torsion: 1 N·m/15 s
Cable holding strength	Tensile: 100 N/15 s, Torsion: 1 N·m/15 s
Lock operating force	0.1 to 0.25 N·m
Ambient operating temperature range	-25 to +70°C *3
Ambient humidity range	20 to 85%RH

*1. State at shipping.

*2. "OMRON's Oil-resistant Component Evaluation Standards" are OMRON's own durability evaluation standards.

Protection performance with oil-resistive connector (XS5F/W-X) correctly mated.

This performance does not apply if an oil-resistive connector (XS5F/W-X) is missing, and cord wiring is exposed.

*3. Use the robot cable within a temperature range of 0 to 70°C to avoid the wire breakage when moving.

Materials and Finishes

Item	Model	XS5F/W-X	XS5F/W-XR
		Oil-resistive PVC cable	Oil-resistive PVC robot cable
Contacts		Copper alloy/Gold plating	
Fixtures		Zinc alloy/Nickel plating	
Fixtures (Lock) *		Stainless	
Pin block		PBT resin	
O-ring		Material combining HNBR and fluororubber	
Cover		PBT resin	
Cable		UL 758 (AWM) 6 mm dia. AWG20	UL 758 (AWM) 6 mm dia. AWG21

* Only plug

Connector Pinout Diagram (from Mating Side)

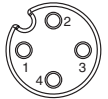
Item	No. of poles	4 poles
A-coding (For DC sensors)	Male (plug) contacts	
	Female (socket) contacts	

Connection Combinations

Socket	Plug OMRON model No.	Smartclick Plug Connectors	M12 Plug Connectors
		XS5H, XS5G, XS5W (plug side), XS5R (plug side), XS5M *	XS2H, XS2G, XS2W (plug side), XS2R (plug side), XS2M *
Smartclick Socket Connectors	XS5F, XS5C XS5W (socket side), XS5R (socket side), XS5P *	⊙	○
M12 Socket Connectors	XS2F, XS2C, XS2W (socket side), XS2R (socket side), XS2P *	○	○

* XS2P/XS5P and XS5M, XS2M cannot mate with each other.

Note: ⊙: Connected by twisting.
○: Connected by screwing.

Dimensions

(Unit: mm)

Both end connector type

XS5W-D421-□81-X

XS5W-D421-□81-XR

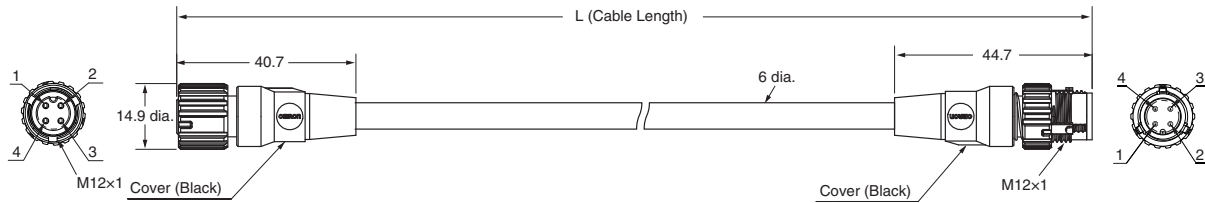

Wiring Diagram for 4 Cores

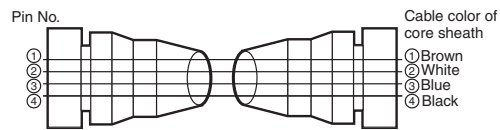

One end connector type

XS5F-D421-□80-X

XS5F-D421-□80-XR

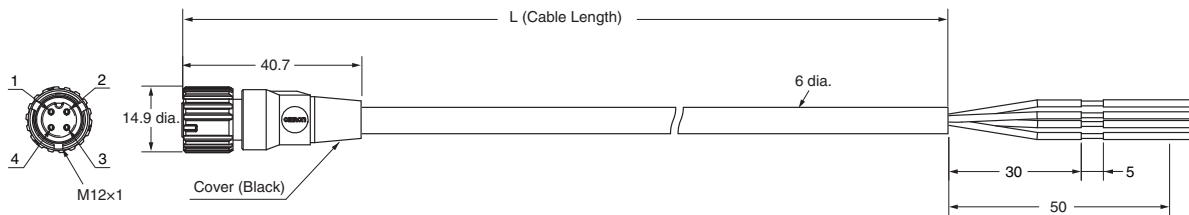

Wiring Diagram for 4 Cores

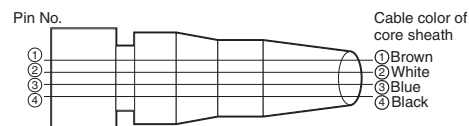

Safety Precautions

Meaning of Display

Precautions for Safe Use	Supplementary comments on what to do or avoid doing, to use the product safely.
Precautions for Correct Use	Supplementary comments on what to do or avoid doing, to prevent failure to operate, malfunction, or undesirable effects on product performance.

Precautions for Safe Use

Degree of Protection

Do not use the product if its protective capabilities have been compromised, such as through swelling or cracks to housing or seal materials.

If products in this state continue to be used, then cutting oil or other contaminants may enter the product, leading to breakages or damage from fire.

Connector Connection and Disconnection

- When connecting or disconnecting Connectors, be sure to hold the Connectors by hand.
- Do not hold the cable when disconnecting Connectors. Check the alignment using the slot in the polarity key.
- Do not wiring the Connector when your hands are wet. Malfunctions or device damage may occur when power is supplied to a device.
- When mating Connectors, be sure to insert the plug all the way to the back of the socket before attempting to lock the Connectors. After you lock a Connector, always confirm that it is mated properly.
- Do not use tools of any sort to mate the Connectors. Always use your hands. Pliers or other tools may damage the Connectors.
- When you replace a Connector, make sure that there is no liquid, cutting oil, or other foreign matter on the mating surfaces before you mate the Connector.

Disposal

Dispose of this product as industrial waste.

Precautions for Correct Use

- Do not use the Connectors in an atmosphere or environment that exceeds the specifications.
- Always turn OFF the power supply before wiring. Failure to turn OFF the power supply may lead to electric shock or damage to devices.
- As usage in environments in which cutting oil is used may impact service life and performance, ensure the following requirements are met.
 - Usage with cutting oil requirements as defined in specifications.
 - Usage at a dilution ratio as recommended by cutting oil manufacturers.
 - Usage immersed in oil or water is prohibited.

The cutting oil used may have a different impact on product service life. Ensure that the product is used only after confirming with the customer that there has been no deformation or deterioration of seal material from the cutting oil.

- The mating coupler will impact the oil-resistance performance values (years). Confirm mating of the couplers before use.

Mating Combinations

	XS5□R	XS5□-X/XR	Other XS5/ XS2 Series
XS5□R	Oil-resistance performance values 4 years	Oil-resistance performance values 2 years	Water-resistance
XS5□-X/XR	Oil-resistance performance values 2 years	Oil-resistance performance values 2 years	Water-resistance
Other XS5/XS2 Series *	Water-resistance	Water-resistance	Water-resistance

* Oil-resistant (polyurethane) cable products (XS5F-P, XS5H-P, XS5W-P) as well as oil-resistant (polyurethane) robot cables (XS5F-PR, XS5W-PR) are excluded. Please consult with OMRON for details of these products.

- Environments with corrosive gases and high temperature and humidity can cause bad connections and damage through corrosion, leading to degraded performance, therefore do not use these products in such environments.
- Do not pull on the Connectors or cables with excessive force.
- Do not step on or place any objects on the Connectors. Doing so may damage the Connectors.
- Lay the cable where it will not be stepped on to prevent the wires in the cable from being disconnected and to protect the Connectors from being damaged. If the cable must be placed where it will be stepped on, install a protective cover.
- At installation, if not installing sensors or switches, and not mating plug connectors, then use water-resistant covers (XS5Z-11, XS2Z-11) or dust-resistant covers (XS2Z-13/14/15) in order to ensure correct connector mating.

Wiring

- Do not wire cables in environments in which the cable terminal sections will be subject to fluids such as water or cutting oil.
- When wiring cables, ensure this is carried out in accordance with the wiring diagram.
- Lay the cables so that external force is not applied to the Connectors. Otherwise, the degree of protection (IP67G) may not be achieved.

Degree of Protection (IP67)

- The degree of protection of Connectors (IP67) is not for a fully watertight structure. Do not use the Connectors underwater.
- Do not step on or place any objects on the Connectors. Doing so may damage the Connectors.

Setup

- Do not install the Connectors with a load placed directly on the joint or at the point where the wires connect to the Connector. The Connector may be damaged or the wires in the cable may be disconnected.
- If bending cables, ensure that these use a minimum bend radius of 40 mm.

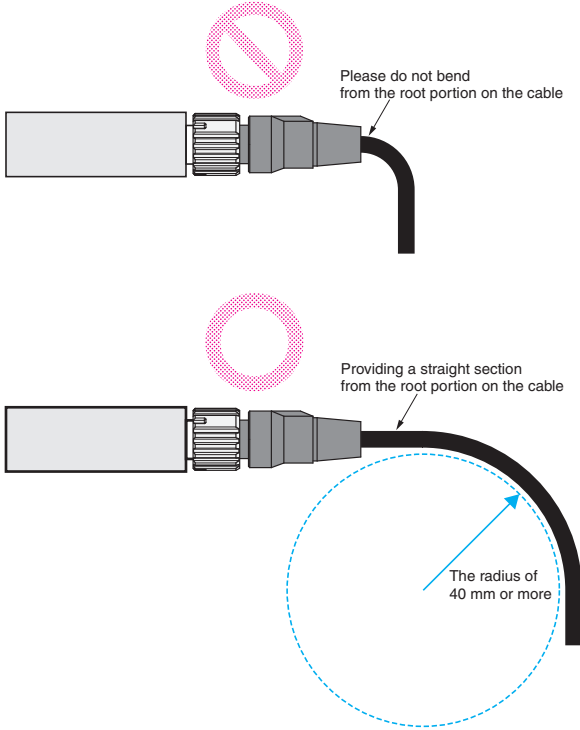

Connecting

1. Connecting the XS5 Plug and Socket

- Align the projection on the plug cover with the polarity key on the socket, then insert the plug all the way in.

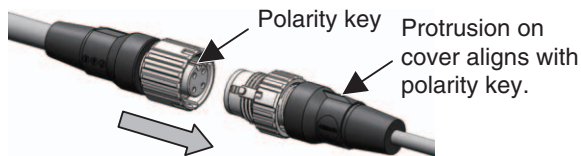

- Hold the knurled socket grip, then insert the projection on the plug into the groove of the socket.

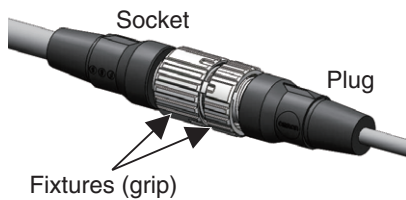

- Turn the knurled grips of the socket clockwise approximately 1/8 turn in respect to the plug. A click will indicate that the Connectors are locked. The locking condition can also be confirmed by the alignment marks on the plug and socket.

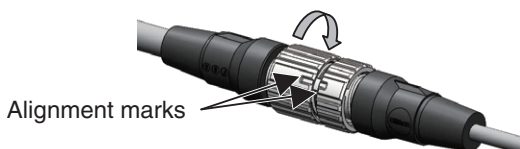

2. Connecting the XS5 and XS2

- Align the projection on the plug cover with the polarity key on the socket, then insert the plug all the way in.
- In the same way as when connecting two XS2 Connectors, screw the knurled grip in the clockwise direction.
- When mating the products to XS2 or other M12 Connectors, tighten the lock to a torque of 0.39 to 0.49 N-m.

XS5

Round Water-resistive Smartclick Connectors for E2E NEXT Series proximity sensors that Reduce Installation Work

- A newly developed lock mechanism that is compatible with round M12 connectors.
- Simply insert the Connectors, then turn them approximately 1/8 of a turn to lock.
- A positive click indicates locking.
- IP67 degree of protection.
- UL approved products.



For the most recent information on models that have been certified for safety standards, refer to your OMRON website.

 Be sure to read *Safety Precautions* on page 100.

Model Number Structure

Model Number Legend

Use this legend when determining the product specifications from the model number. When ordering, use a model number from the table in **Ordering Information**.

XS5 **-D** **4** **2** **-** **8** **-** **F**

1 2 3 4 5 6 7 8 9

1. Type

W: Connectors connected to cable, socket and plug on cable ends
F: Connectors connected to cable, socket on one cable end

2. Mating Section Form

D: A-coding (for DC sensor)

3. Connector Poles

4: 4 poles

4. Contact Plating

2: Gold plating

5. Cable Connection Direction

XS5W

- 1: Straight (Socket)/Straight (Plug)
- 2: Right-angle (Socket)/Right-angle (Plug)
- 3: Straight (Socket)/Right-angle (Plug)
- 4: Right-angle (Socket)/Straight (Plug)

XS5F

- 1: Straight
- 2: Right-angle

6. Cable Length

- C: 1 m
- D: 2 m
- E: 3 m
- G: 5 m
- J: 10 m

7. Connections (Numbers inside circles are terminal numbers)

8: ABrown, BWhite, CBlue, D Black

8. Connectors on One End/Both Ends

- 0: Sockets on One Cable End
- 1: Socket and Plug on Cable Ends

9. Cable Specifications

F: Robot cable

 Smartclick is registered trademark of OMRON Corporation.

Ordering Information

Connectors

Type	Cable outer diameter (mm)	Cable Connection Direction	Cable length (m)	Model	UL
Socket and Plug on Cable Ends XS5W	6 dia.	Straight (Socket)/Straight (Plug)	1	XS5W-D421-C81-F	UL2238 certified (File no. E207683)
			2	XS5W-D421-D81-F	
			3	XS5W-D421-E81-F	
			5	XS5W-D421-G81-F	
			10	XS5W-D421-J81-F	
		Right-angle (Socket)/Right-angle (Plug)	2	XS5W-D422-D81-F	
			5	XS5W-D422-G81-F	
		Straight (Socket)/Right-angle (Plug)	2	XS5W-D423-D81-F	
			5	XS5W-D423-G81-F	
		Right-angle (Socket)/Straight (Plug)	2	XS5W-D424-D81-F	
			5	XS5W-D424-G81-F	
		Sockets on One Cable End XS5F	6 dia.	Straight type	
2	XS5F-D421-D80-F				
3	XS5F-D421-E80-F				
5	XS5F-D421-G80-F				
10	XS5F-D421-J80-F				
Right-angle type	1			XS5F-D422-C80-F	
	2			XS5F-D422-D80-F	
	3			XS5F-D422-E80-F	
	5			XS5F-D422-G80-F	
	10			XS5F-D422-J80-F	

E2E/E2EQ NEXT Series DC 3-wire

E2E/E2EQ NEXT Series DC 2-wire

XS5 NEXT Series

XS5

XS3

Accessories (Sold Separately)

Connector Covers

Water-resistant Covers

Model	Material	Suitable connector		Remarks
		Model	Mounting portion	
XS2Z-11	Brass/ Nickel plated	XS5W	M12 male screw	This provides IP67 levels of protection. When mounting the Water-resistant Cover to a Connector, be sure to apply a torque range between 0.39 and 0.49 N·m to tighten the Water-resistant Cover.
XS5Z-11	PBT	XS5F/XS5W	M12 female screw	This provides IP67 levels of protection. This uses the Smart click mechanism. There's no need to keep track of locking torque.

Water-resistant Covers

XS2Z-11

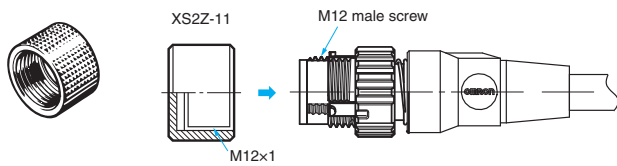

XS5Z-11

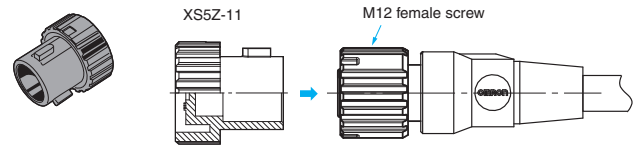

Dust Covers

Model	Material	Suitable connector		Remarks
		Model	Mounting portion	
XS2Z-13	Rubber/Black	XS5W	M12 male screw	The Dust Cover is for dust prevention and does not ensure IP67 degree of protection. When mounting the Dust Cover to a connector, be sure to press the Dust Cover onto the Connector until the Connector is fully inserted into the Dust Cover.
XS2Z-14		XS5F/XS5W	Contact blocks (female contact)	
XS2Z-15			M12 female screw	

Dust Covers

XS2Z-13

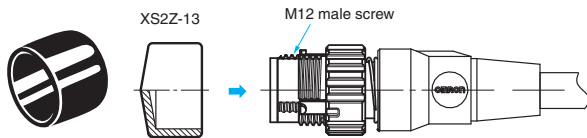

XS2Z-15/XS2Z-14

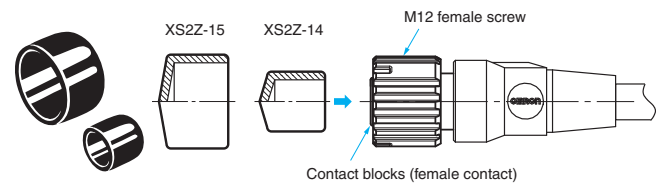

Ratings and Specifications

Rated current	4 A
Rated voltage	250 VDC
Contact resistance (connector)	40 mΩ max. (at 20 mV max., 100 mA max.)
Insulation resistance	1,000 MΩ min. (at 500 VDC) *1
Dielectric strength (connector)	1,500 VAC for 1 minute (leakage current: 1 mA max.)
Degree of protection	IP67 (IEC 60529)
Insertion tolerance	50 times
Lock strength	Tensile: 100 N/15 s, Torsion: 1 N·m/15 s
Cable holding strength	Tensile: 100 N/15 s, Torsion: 1 N·m/15
Lock operating force	0.1 to 0.25 N·m
Ambient operating temperature range	-25 to 70°C *2
Ambient humidity range	20 to 85%RH



*1. State at shipping.

*2. Use the robot cable within a temperature range of 0 to 70°C to avoid the wire breakage when moving.

Materials and Finishes

Item	Model	XS5W/XS5F
Contacts		Copper alloy/Gold plating
Fixtures		Zinc alloy/Nickel plating
Pin block		PBT resin
O-ring		Rubber
Cover		PBT resin
Cable		UL13 (CL3), UL758 (AWM), 6 mm dia., AWG20

Connector Pinout Diagram (from Mating Side)

Item	No. of poles	4 poles
A-coding (For DC sensors)	Male (plug) contacts	
	Female (socket) contacts	

Connection

Socket	Plug OMRON model No.	Smartclick Plug Connectors	M12 Plug Connectors
		XS5H, XS5G, XS5W (plug side), XS5R (plug side), XS5M *	XS2H, XS2G, XS2W (plug side), XS2R (plug side), XS2M *
Smartclick Socket Connectors	XS5F, XS5C XS5W (socket side), XS5R (socket side), XS5P *	⊙	○
M12 Socket Connectors	XS2F, XS2C, XS2W (socket side), XS2R (socket side), XS2P *	○	○

* XS2P/XS5P and XS5M, XS2M cannot mate with each other.

Note: ⊙: Connected by twisting.

○: Connected by screwing.

XS5

Dimensions

(Unit: mm)

Socket and Plug on Cable Ends XS5W

Straight (Socket)/straight (Plug)

XS5W-D421-□81-F

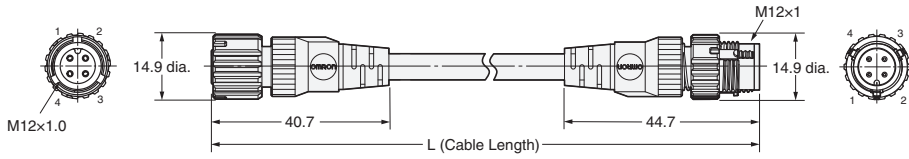

Right-angle (Socket)/right-angle (Plug)

XS5W-D422-□81-F

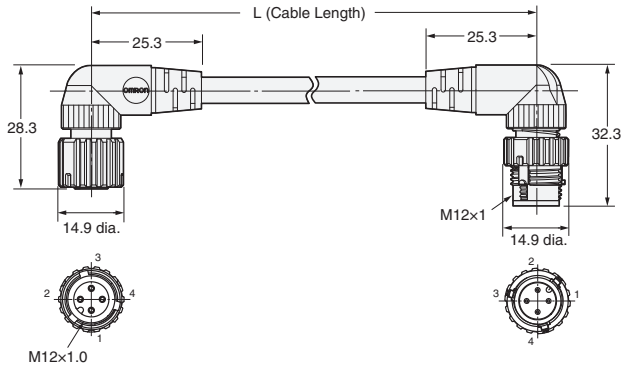

Straight (Socket)/right-angle (Plug)

XS5W-D423-□81-F

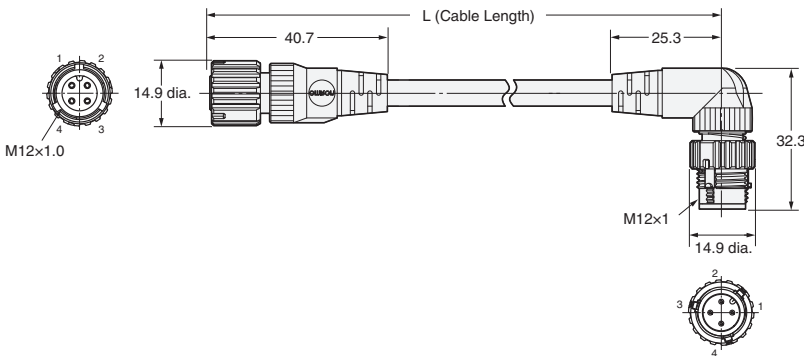

Wiring Diagram for 4 Cores

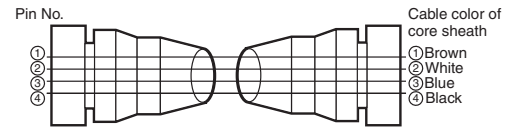

Right-angle (Socket)/straight (Plug)

XS5W-D424-□81-F

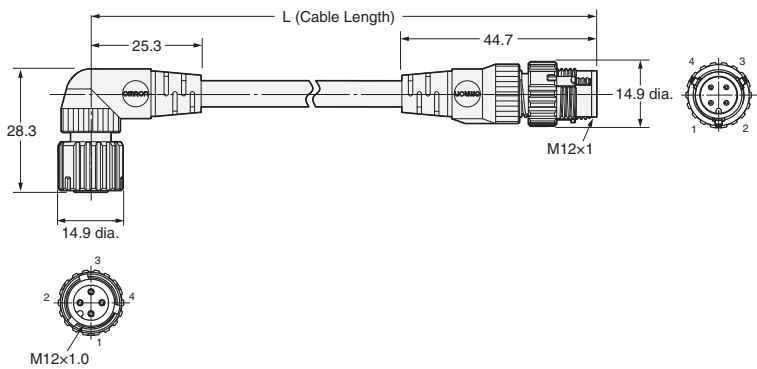

Sockets on One Cable End XS5F

Straight type

XS5F-D421-□80-F

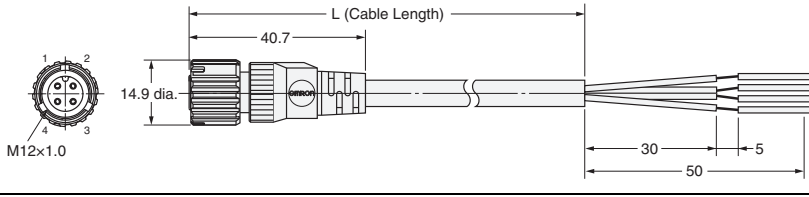

Right-angle type

XS5F-D422-□80-F

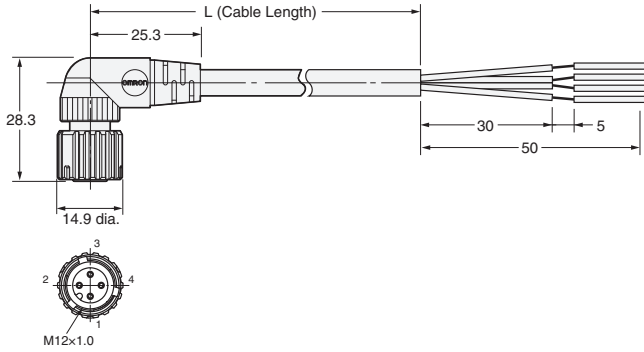

Wiring Diagram for 4 Cores

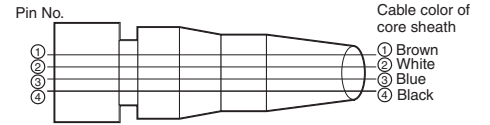

Safety Precautions

Meaning of Display

Precautions for Safe Use	Supplementary comments on what to do or avoid doing, to use the product safely.
Precautions for Correct Use	Supplementary comments on what to do or avoid doing, to prevent failure to operate, malfunction, or undesirable effects on product performance.

Precautions for Safe Use

Degree of Protection

Do not use the product if its protective capabilities have been compromised, such as through swelling or cracks to housing or seal materials.

Breakages or damage from fire may occur when products in this state continue to be used.

Connector Connection and Disconnection

- When connecting or disconnecting Connectors, be sure to hold the Connectors by hand.
- Do not hold the cable when disconnecting Connectors. Check the alignment using the slot in the polarity key.
- Do not wiring the Connector when your hands are wet. Malfunctions or device damage may occur when power is supplied to a device.
- When mating Connectors, be sure to insert the plug all the way to the back of the socket before attempting to lock the Connectors. After you lock a Connector, always confirm that it is mated properly.
- Do not use tools of any sort to mate the Connectors. Always use your hands. Pliers or other tools may damage the Connectors.
- When you replace a Connector, make sure that there is no liquid, cutting oil, or other foreign matter on the mating surfaces before you mate the Connector.

Disposal

Dispose of this product as industrial waste.

Precautions for Correct Use

- Do not use the Connectors in an atmosphere or environment that exceeds the specifications.
- Always turn OFF the power supply before wiring. Failure to turn OFF the power supply may lead to electric shock or damage to devices.
- Environments with corrosive gases and high temperature and humidity can cause bad connections and damage through corrosion, leading to degraded performance, therefore do not use these products in such environments.
- Do not pull on the Connectors or cables with excessive force.
- Do not step on or place any objects on the Connectors. Doing so may damage the Connectors.
- Lay the cable where it will not be stepped on to prevent the wires in the cable from being disconnected and to protect the Connectors from being damaged. If the cable must be placed where it will be stepped on, install a protective cover.
- At installation, if not installing sensors or switches, and not mating plug connectors, then use water-resistant covers (XS5Z-11, XS2Z-11) or dust-resistant covers (XS2Z-13/14/15) in order to ensure correct connector mating.

Wiring

- Do not wire cables in environments in which the cable terminal sections will be subject to fluids such as water or cutting oil.
- When wiring cables, ensure this is carried out in accordance with the wiring diagram.
- Lay the cables so that external force is not applied to the Connectors. Otherwise, the degree of protection (IP67G) may not be achieved.

Degree of Protection (IP67)

- The degree of protection of Connectors (IP67) is not for a fully watertight structure. Do not use the Connectors underwater.
- Do not step on or place any objects on the Connectors. Doing so may damage the Connectors.

Setup

- Do not install the Connectors with a load placed directly on the joint or at the point where the wires connect to the Connector. The Connector may be damaged or the wires in the cable may be disconnected.
- If bending cables, ensure that these use a minimum bend radius of 40 mm.

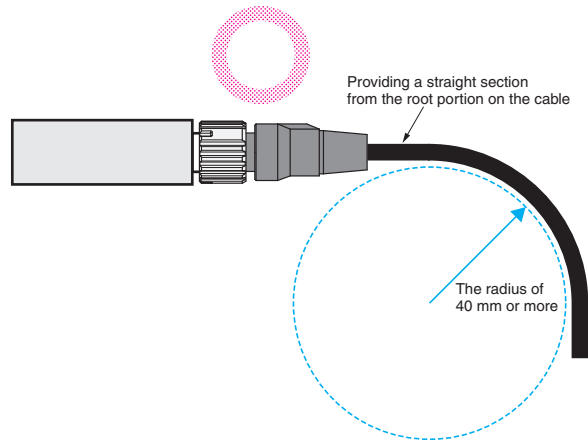
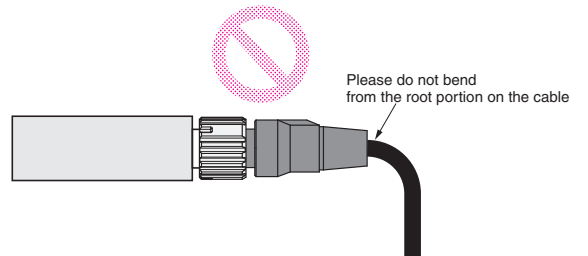

Connecting

1. Connecting the XS5 Plug and Socket

- Align the projection on the plug cover with the polarity key on the socket, then insert the plug all the way in.

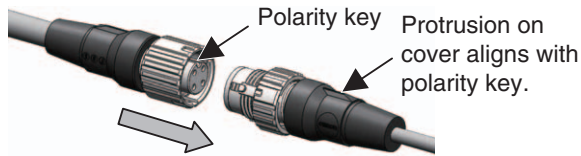

- Hold the knurled socket grip, then insert the projection on the plug into the groove of the socket.

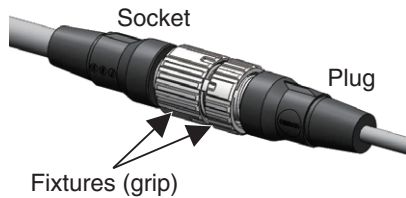

- Turn the knurled grips of the socket clockwise approximately 1/8 turn in respect to the plug. A click will indicate that the Connectors are locked. The locking condition can also be confirmed by the alignment marks on the plug and socket.

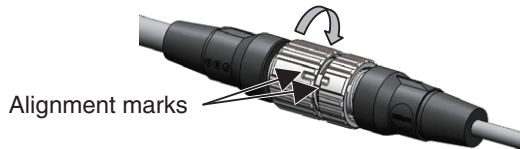

2. Connecting the XS5 and XS2

- Align the projection on the plug cover with the polarity key on the socket, then insert the plug all the way in.
- In the same way as when connecting two XS2 Connectors, screw the knurled grip in the clockwise direction.
- Use your fingers to tighten the Connectors sufficiently.

Terms and Conditions Agreement

Read and understand this catalog.

Please read and understand this catalog before purchasing the products. Please consult your OMRON representative if you have any questions or comments.

Warranties.

- (a) Exclusive Warranty. Omron's exclusive warranty is that the Products will be free from defects in materials and workmanship for a period of twelve months from the date of sale by Omron (or such other period expressed in writing by Omron). Omron disclaims all other warranties, express or implied.
- (b) Limitations. OMRON MAKES NO WARRANTY OR REPRESENTATION, EXPRESS OR IMPLIED, ABOUT NON-INFRINGEMENT, MERCHANTABILITY OR FITNESS FOR A PARTICULAR PURPOSE OF THE PRODUCTS. BUYER ACKNOWLEDGES THAT IT ALONE HAS DETERMINED THAT THE PRODUCTS WILL SUITABLY MEET THE REQUIREMENTS OF THEIR INTENDED USE.

Omron further disclaims all warranties and responsibility of any type for claims or expenses based on infringement by the Products or otherwise of any intellectual property right. (c) Buyer Remedy. Omron's sole obligation hereunder shall be, at Omron's election, to (i) replace (in the form originally shipped with Buyer responsible for labor charges for removal or replacement thereof) the non-complying Product, (ii) repair the non-complying Product, or (iii) repay or credit Buyer an amount equal to the purchase price of the non-complying Product; provided that in no event shall Omron be responsible for warranty, repair, indemnity or any other claims or expenses regarding the Products unless Omron's analysis confirms that the Products were properly handled, stored, installed and maintained and not subject to contamination, abuse, misuse or inappropriate modification. Return of any Products by Buyer must be approved in writing by Omron before shipment. Omron Companies shall not be liable for the suitability or unsuitability or the results from the use of Products in combination with any electrical or electronic components, circuits, system assemblies or any other materials or substances or environments. Any advice, recommendations or information given orally or in writing, are not to be construed as an amendment or addition to the above warranty.

See <http://www.omron.com/global/> or contact your Omron representative for published information.

Limitation on Liability; Etc.

OMRON COMPANIES SHALL NOT BE LIABLE FOR SPECIAL, INDIRECT, INCIDENTAL, OR CONSEQUENTIAL DAMAGES, LOSS OF PROFITS OR PRODUCTION OR COMMERCIAL LOSS IN ANY WAY CONNECTED WITH THE PRODUCTS, WHETHER SUCH CLAIM IS BASED IN CONTRACT, WARRANTY, NEGLIGENCE OR STRICT LIABILITY.

Further, in no event shall liability of Omron Companies exceed the individual price of the Product on which liability is asserted.

Suitability of Use.

Omron Companies shall not be responsible for conformity with any standards, codes or regulations which apply to the combination of the Product in the Buyer's application or use of the Product. At Buyer's request, Omron will provide applicable third party certification documents identifying ratings and limitations of use which apply to the Product. This information by itself is not sufficient for a complete determination of the suitability of the Product in combination with the end product, machine, system, or other application or use. Buyer shall be solely responsible for determining appropriateness of the particular Product with respect to Buyer's application, product or system. Buyer shall take application responsibility in all cases.

NEVER USE THE PRODUCT FOR AN APPLICATION INVOLVING SERIOUS RISK TO LIFE OR PROPERTY OR IN LARGE QUANTITIES WITHOUT ENSURING THAT THE SYSTEM AS A WHOLE HAS BEEN DESIGNED TO ADDRESS THE RISKS, AND THAT THE OMRON PRODUCT(S) IS PROPERLY RATED AND INSTALLED FOR THE INTENDED USE WITHIN THE OVERALL EQUIPMENT OR SYSTEM.

Programmable Products.

Omron Companies shall not be responsible for the user's programming of a programmable Product, or any consequence thereof.

Performance Data.

Data presented in Omron Company websites, catalogs and other materials is provided as a guide for the user in determining suitability and does not constitute a warranty. It may represent the result of Omron's test conditions, and the user must correlate it to actual application requirements. Actual performance is subject to the Omron's Warranty and Limitations of Liability.

Change in Specifications.

Product specifications and accessories may be changed at any time based on improvements and other reasons. It is our practice to change part numbers when published ratings or features are changed, or when significant construction changes are made. However, some specifications of the Product may be changed without any notice. When in doubt, special part numbers may be assigned to fix or establish key specifications for your application. Please consult with your Omron's representative at any time to confirm actual specifications of purchased Product.

Errors and Omissions.

Information presented by Omron Companies has been checked and is believed to be accurate; however, no responsibility is assumed for clerical, typographical or proofreading errors or omissions.

-  Smartclick is a registered trademark of OMRON Corporation.
- Company names and product names in this document are the trademarks or registered trademarks of their respective companies.
- The product photographs and figures that are used in this catalog may vary somewhat from the actual products.

Note: Do not use this document to operate the Unit.

OMRON Corporation Industrial Automation Company
Kyoto, JAPAN

Contact: www.ia.omron.com

Regional Headquarters

OMRON EUROPE B.V.
Wegalaan 67-69, 2132 JD Hoofddorp
The Netherlands
Tel: (31)2356-81-300/Fax: (31)2356-81-388

OMRON ELECTRONICS LLC
2895 Greenspoint Parkway, Suite 200
Hoffman Estates, IL 60169 U.S.A.
Tel: (1) 847-843-7900/Fax: (1) 847-843-7787

OMRON ASIA PACIFIC PTE. LTD.
No. 438A Alexandra Road # 05-05/08 (Lobby 2),
Alexandra Technopark,
Singapore 119967
Tel: (65) 6835-3011/Fax: (65) 6835-2711

OMRON (CHINA) CO., LTD.
Room 2211, Bank of China Tower,
200 Yin Cheng Zhong Road,
PuDong New Area, Shanghai, 200120, China
Tel: (86) 21-5037-2222/Fax: (86) 21-5037-2200

Authorized Distributor:

© OMRON Corporation 2018-2021 All Rights Reserved.
In the interest of product improvement,
specifications are subject to change without notice.

CSM_2_1
Cat. No. D121-E1-05

0421(1218)