



Micro Commercial Components

Micro Commercial Components
 20736 Marilla Street Chatsworth
 CA 91311
 Phone: (818) 701-4933
 Fax: (818) 701-4939

DTA123JUA

PNP Digital Transistors

Features

- Built-in bias resistors enable the configuration of an inverter circuit without connecting external input resistors
- The bias resistors consist of thin-film resistors with complete isolation to allow negative biasing of the input. They also have the advantage of almost completely eliminating parasitic effects.
- Only the on/off conditions need to be set for operation, making device design easy

Absolute maximum ratings @ 25°C

Symbol	Parameter	Min	Typ	Max	Unit
V_{CC}	Supply voltage	---	-50	---	V
V_{IN}	Input voltage	-12	---	5	V
I_o $I_{C(MAX)}$	Output current	---	-100	---	mA
P_d	Power dissipation	---	200	---	mW
T_j	Junction temperature	---	150	---	°C
T_{stg}	Storage temperature	-55	---	150	°C

Electrical Characteristics @ 25°C

Symbol	Parameter	Min	Typ	Max	Unit
$V_{I(off)}$	Input voltage ($V_{CC}=-5V, I_o=-100 \mu A$)	---	---	-0.5	V
$V_{I(on)}$	Input voltage ($V_O=-0.3V, I_o=-5mA$)	-1.1	---	---	V
$V_{O(on)}$	Output voltage ($I_o/I_i=-5mA/-0.25mA$)	---	---	-0.3	V
I_i	Input current ($V_i=-5V$)	---	---	-3.6	mA
$I_{O(off)}$	Output current ($V_{CC}=-50V, V_i=0$)	---	---	-0.5	μA
G_1	DC current gain ($V_O=-5V, I_o=-10mA$)	80	---	---	
R_1	Input resistance	1.54	2.2	2.86	K Ω
R_2/R_1	Resistance ratio	17	21	26	
f_T	Transition frequency ($V_{CE}=-10V, I_E=5mA, f=100MHz$)	---	250	---	MHz

Equivalent circuit

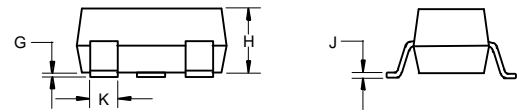
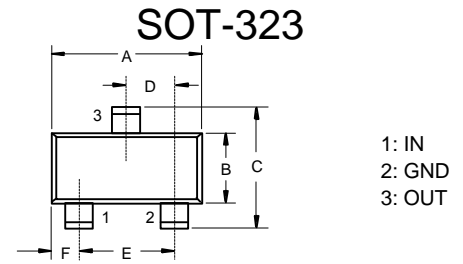
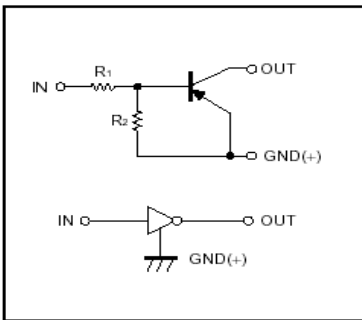

DIM	INCHES		MM		NOTE
	MIN	MAX	MIN	MAX	
A	.071	.087	1.80	2.20	
B	.045	.053	1.15	1.35	
C	.079	.087	2.00	2.20	
D	.026 Nominal		0.65Nominal		
E	.047	.055	1.20	1.40	
F	.012	.016	.30	.40	
G	.000	.004	.000	.100	
H	.035	.039	.90	1.00	
J	.004	.010	.100	.250	
K	.012	.016	.30	.40	

Suggested Solder Pad Layout

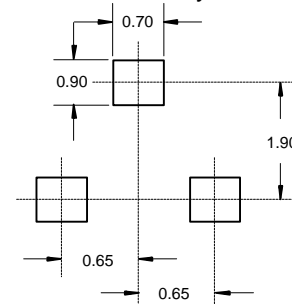

●Electrical characteristic curves

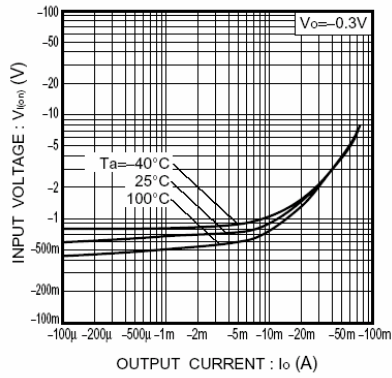

Fig.1 Input voltage vs. output current (ON characteristics)

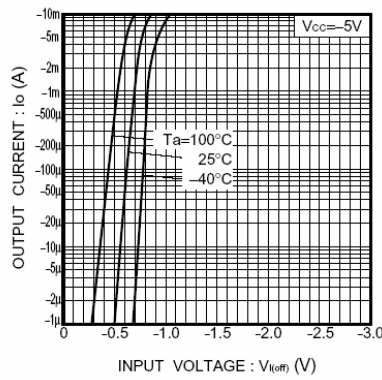

Fig.2 Output current vs. input voltage (OFF characteristics)

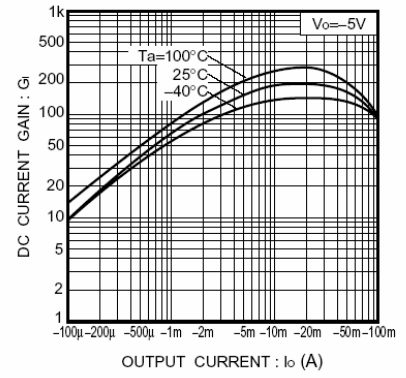

Fig.3 DC current gain vs. output current

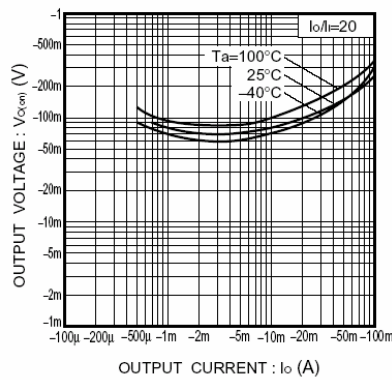

Fig.4 Output voltage vs. output current