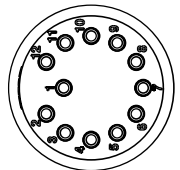
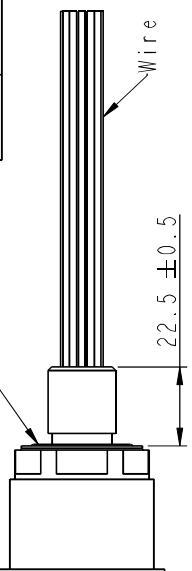
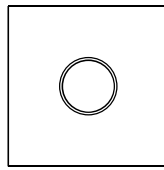
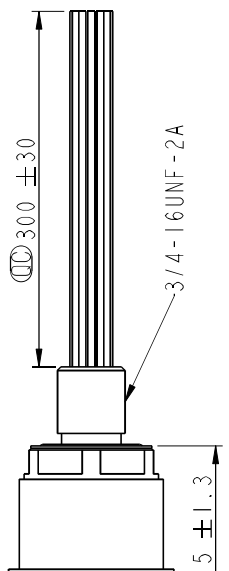
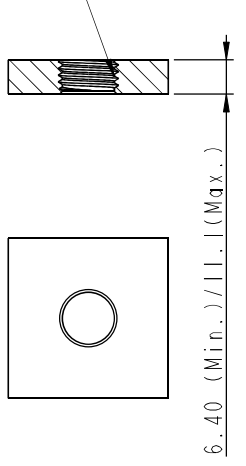
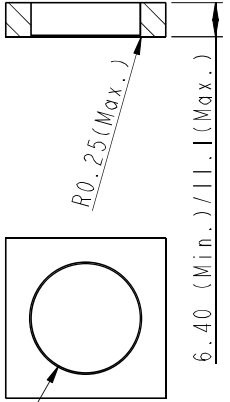
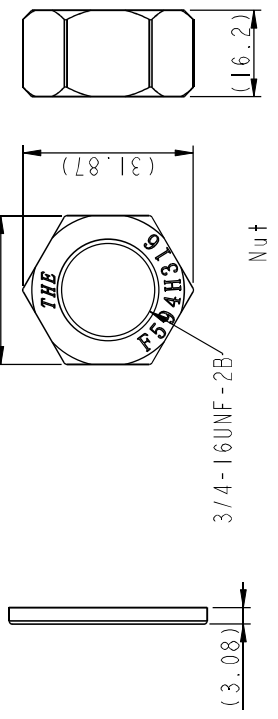
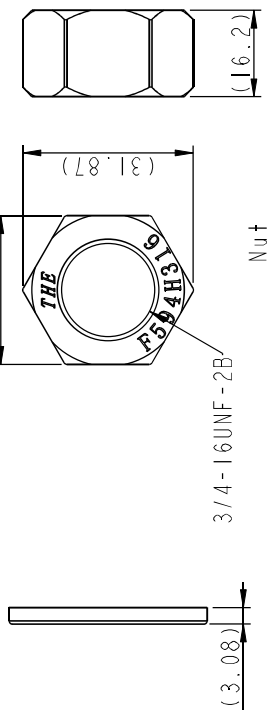
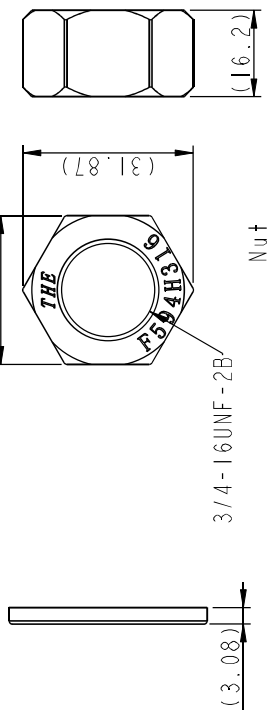
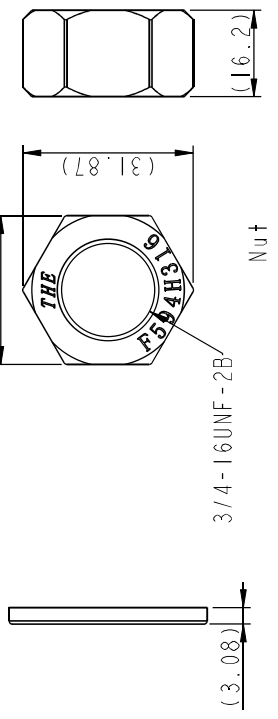

F	DT-HCN-XXRFF-RHA30	REV. ECN NO. DATE SIGN DESCRIPTION A 2022/09/30 Eagle Rev.01 to Rev.A	REV. ECN NO. DATE SIGN DESCRIPTION	REV. ECN NO. DATE SIGN DESCRIPTION	REV. ECN NO. DATE SIGN DESCRIPTION	REV. ECN NO. DATE SIGN DESCRIPTION	REV. ECN NO. DATE SIGN DESCRIPTION	REV. ECN NO. DATE SIGN DESCRIPTION
E	<p>G3: 3Pin G4: 4Pin G6: 6Pin G8: 8Pin G12: 12Pin</p> 	<p>For 12P</p> 						<p>Note: * Important Dimension. * Waterproof Rate: Hadopelagic 7000M, Mated. * Connector Housing: Rubber, Black. Pin: Copper Alloy, Gold Plated. O-Ring: Rubber, Black. Shield: Metal. Nut: Metal. Washer: Metal. Wire: UL10393 18 AWG, OD 1.81mm Washer and nut are packed separately in PE bag.</p>
D		<p>DT, HAD CIRCULAR MINI REAR FASTENED, F, F</p> <p>SCALE: 1:1 SHEET: A4 OF 5 REV. A NC-REV. A.5 (C): Inspection item</p>	<p>UNIT: mm TOLERANCE ±0.5</p>	<p>DT-HCN-XXRFF-RHA30</p>	<p>DT-HCN-XXRFF-RHA30</p>	<p>DT-HCN-XXRFF-RHA30</p>	<p>DT-HCN-XXRFF-RHA30</p>	<p>DT-HCN-XXRFF-RHA30</p>
C	<p>YY(年) WW(週) LT左右置中</p>	<p>DT, HAD CIRCULAR MINI REAR FASTENED, F, F</p>	<p>UNIT: mm TOLERANCE ±0.5</p>	<p>DT-HCN-XXRFF-RHA30</p>	<p>DT-HCN-XXRFF-RHA30</p>	<p>DT-HCN-XXRFF-RHA30</p>	<p>DT-HCN-XXRFF-RHA30</p>	<p>DT-HCN-XXRFF-RHA30</p>
B		<p>DT, HAD CIRCULAR MINI REAR FASTENED, F, F</p>	<p>UNIT: mm TOLERANCE ±0.5</p>	<p>DT-HCN-XXRFF-RHA30</p>	<p>DT-HCN-XXRFF-RHA30</p>	<p>DT-HCN-XXRFF-RHA30</p>	<p>DT-HCN-XXRFF-RHA30</p>	<p>DT-HCN-XXRFF-RHA30</p>
A		<p>DT, HAD CIRCULAR MINI REAR FASTENED, F, F</p>	<p>UNIT: mm TOLERANCE ±0.5</p>	<p>DT-HCN-XXRFF-RHA30</p>	<p>DT-HCN-XXRFF-RHA30</p>	<p>DT-HCN-XXRFF-RHA30</p>	<p>DT-HCN-XXRFF-RHA30</p>	<p>DT-HCN-XXRFF-RHA30</p>

Amphenol LTW

安費諾亮泰企業股份有限公司

UNIT: mm	TOLERANCE ±0.5	SCALE: 1:1	SHEET: A4	OF: 5	REV. A	NC-REV. A.5	(C): Inspection item
TITLE: DT, HAD CIRCULAR MINI REAR FASTENED, F, F				ITEM NO. DT-HCN-XXRFF-RHA30			
DRAWN BY: Eagle				DATE: 2022/09/30			
CHECKED BY: Aric				DATE: 2022/09/30			
APPROVED BY: Max				DATE: 2022/09/30			

8 7 6 5 4 3 2 1

For 6P/8P

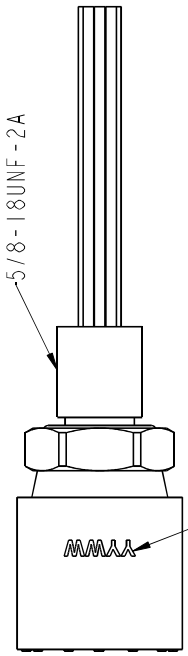
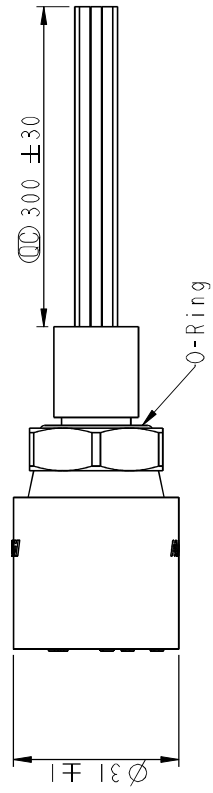
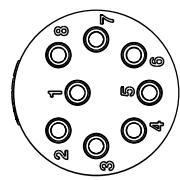
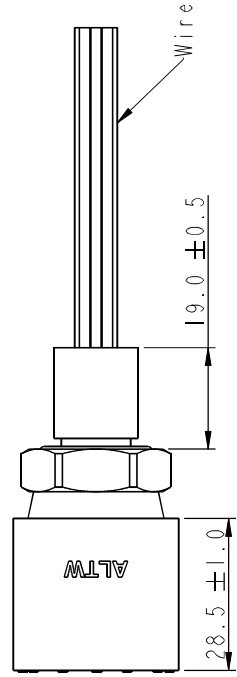

Ⓞ Date Code (Laser mark)
YY (年)
WW (週)

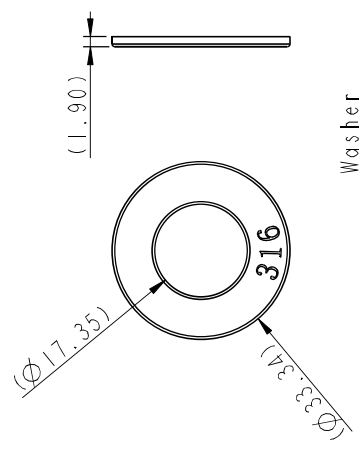

Washer

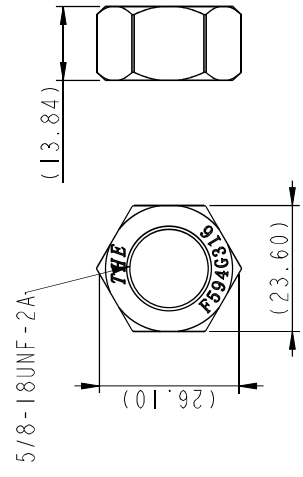

Nut

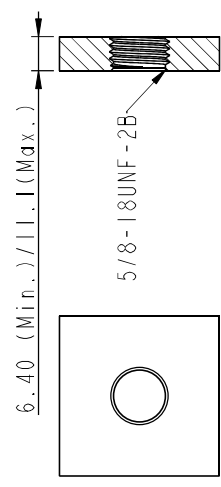

Panel cut out (screw type)

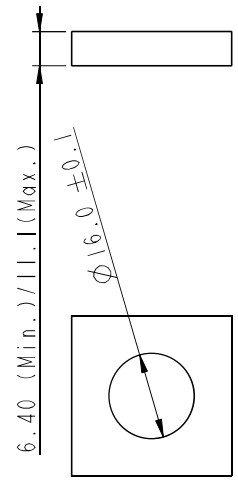

Panel cut out (hole type)

UNIT: mm	TITLE	ITEM NO	DRAWN BY	DATE
TOLERANCE ±0.5	DT, HAD CIRCULAR MINI REAR FASTENED, F, F		Eagle	2022/09/30
SCALE 1:1	SHEET A4	DT-HCN-XXRFF-RHA30	CHECKED BY	DATE
REV. A	REV. A.5	ALTW	Ar ic	2022/09/30
	Ⓞ: Inspection item		APPROVED BY	DATE
			Max	2022/09/30

Amphenol LTW
安費諾亮泰企業股份有限公司

8 W10814-03-0001A2

8 7 6 5 4 3 2 1

For 3P/4P

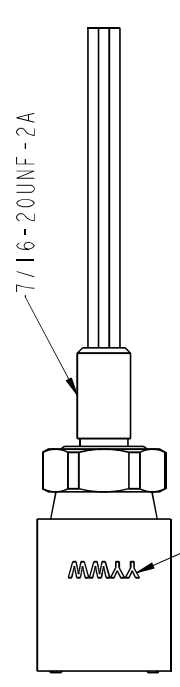
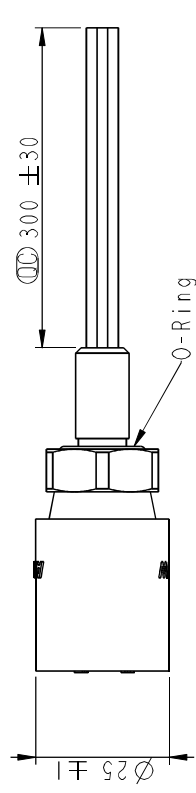
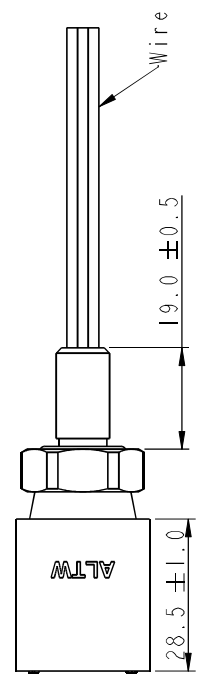

☉ Date Code (Laser mark)
YY(年)
WW(週)

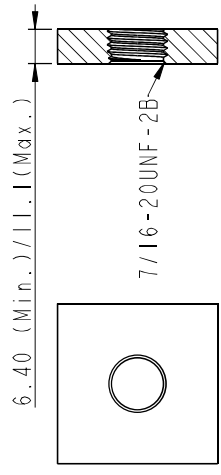
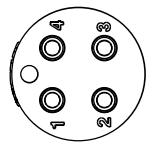

Panel cut out (screw type)

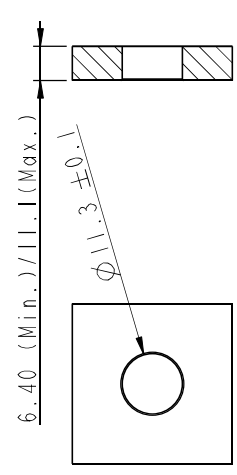

Panel cut out (hole type)

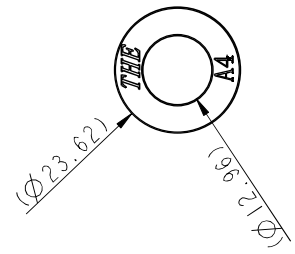

Washer

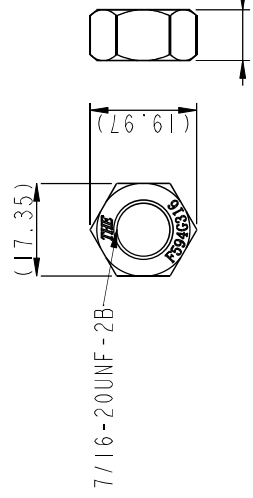

Nut

UNIT: mm	TITLE	ITEM NO	DRAWN BY	DATE
TOLERANCE ±0.5	DT, HAD CIRCULAR MINI REAR FASTENED, F, F		Eagle	2022/09/30
SCALE 1:1	SIZE A4	ENG NO	CHECKED BY	DATE
REV. A	SHEET 3 OF 5	DT-HCN-XXRFF-RHA30	Aric	2022/09/30
	☉: Inspection item	CUSTOMER	APPROVED BY	DATE
		ALTW	Max	2022/09/30
				8 WJ0814-03-0001A2

8
7
6
5
4
3
2

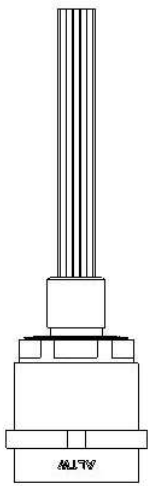
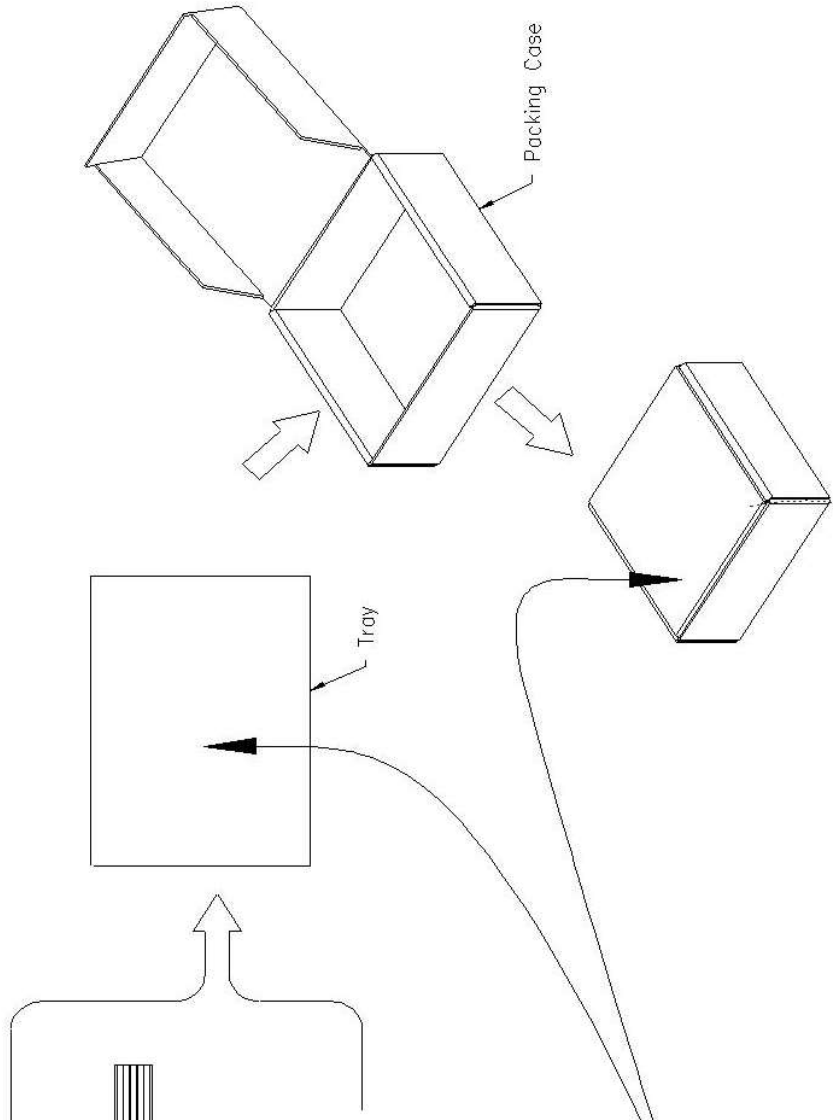

3P/4P/6P/8P: 10PCS(Max.)
12P: 8PCS(Max.)

年 月 合格品 RoHS2.0

料號: _____ 廠商: 昆山安費諾正日電子

數量: _____ PC 日期: _____

Lot No: _____ 版本: _____

採購單號: _____

廠商料號: _____

UNIT: mm		TITLE	DT, HAD CIRCULAR MINI REAR FASTENED, F, F		ITEM NO	DRWN BY	DATE
TOLERANCE ±0.5		SCALE	1:1	SHEET 5 OF 5	DT-HCN-XXRFF-RHA30	Eagle	2022/09/30
		REV.	A	WC-REV. A.5	ALTW	Ar ic	2022/09/30
				Ⓢ: Inspection item	Max	Max	2022/09/30
							8 WJ0814-03-0001A2

Amphenol LTW
安費諾亮泰企業股份有限公司