

DS80PCI810 Low-Power 8 Gbps 8-Channel Linear Repeater

1 Features

- Low 70 mW/Channel (Typ) Power Consumption, With Option to Power Down Unused Channels
- Seamless Link Training Support
- Advanced Configurable Signal Conditioning I/O
 - Receive CTLE up to ~10 dB at 4 GHz
 - Linear Output Driver
 - Variable Output Voltage Range up to 1200 mVp-p
- Automatic Receiver Detect (Hot-Plug)
- Ultra-Low Input-to-Output Latency: 80 ps (Typ)
- Programmable via Pin Selection, EEPROM, or SMBus Interface
- Single Supply Voltage: 2.5 V or 3.3 V
- 4 kV HBM ESD Rating
- -40°C to 85°C Operating Temperature Range
- Flow-Thru Layout in 10 mm x 5.5 mm 54-Pin Leadless WQFN Package
- Pin Compatible with DS80PCI800

2 Applications

- PCI Express Gen-1, 2, and 3
- Other Proprietary High Speed Interfaces Up to 8 Gbps

3 Description

The DS80PCI810 is an extremely low-power high-performance repeater/redriver designed to support eight channels carrying high speed interface up to 8 Gbps, such as PCIe Gen-1, 2, and 3. The receiver's continuous time linear equalizer (CTLE) provides high frequency boost that is programmable from 2.7 to 9.5 dB at 4 GHz (8 Gbps) followed by a linear output driver. The CTLE receiver is capable of opening an input eye that is completely closed due to inter symbol interference (ISI) induced by interconnect medium such as board traces or twin axial-copper cables. The programmable equalization maximizes the flexibility of physical placement within the interconnect channel and improves overall channel performance.

When operating in PCIe applications, the DS80PCI810 preserves transmit signal characteristics, thereby allowing the host controller and the end point to negotiate transmit equalizer coefficients. This transparency in the link training protocol facilitates system level interoperability and minimizes latency.

The programmable settings can be applied easily via pin control, software (SMBus or I2C), or direct loading from an external EEPROM. In EEPROM mode, the configuration information is automatically loaded on power up, thereby eliminating the need for an external microprocessor or software driver.

Simplified Functional Block Diagram

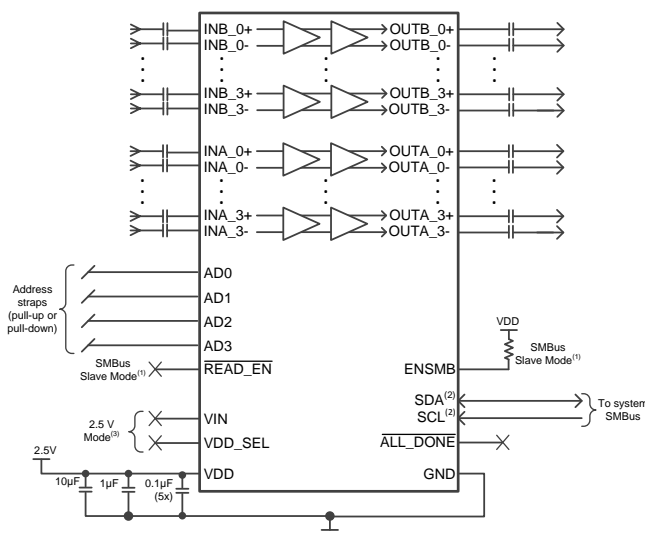

- (1) Schematic requires different connections for SMBus Master Mode and Pin Mode
 (2) SMBus signals need to be pulled up elsewhere in the system.
 (3) Schematic requires different connections for 3.3 V mode

Device Information⁽¹⁾

PART NUMBER	PACKAGE	BODY SIZE (NOM)
DS80PCI810	WQFN (54)	10 mm x 5.5 mm

(1) For all available packages, see the orderable addendum at the end of the datasheet.

Typical Application Block Diagram

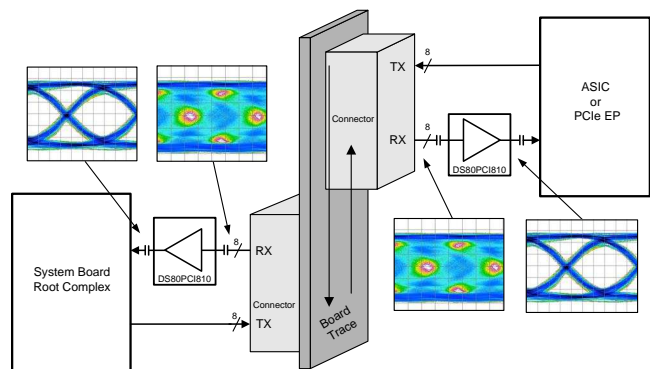

5 Pin Configuration and Functions

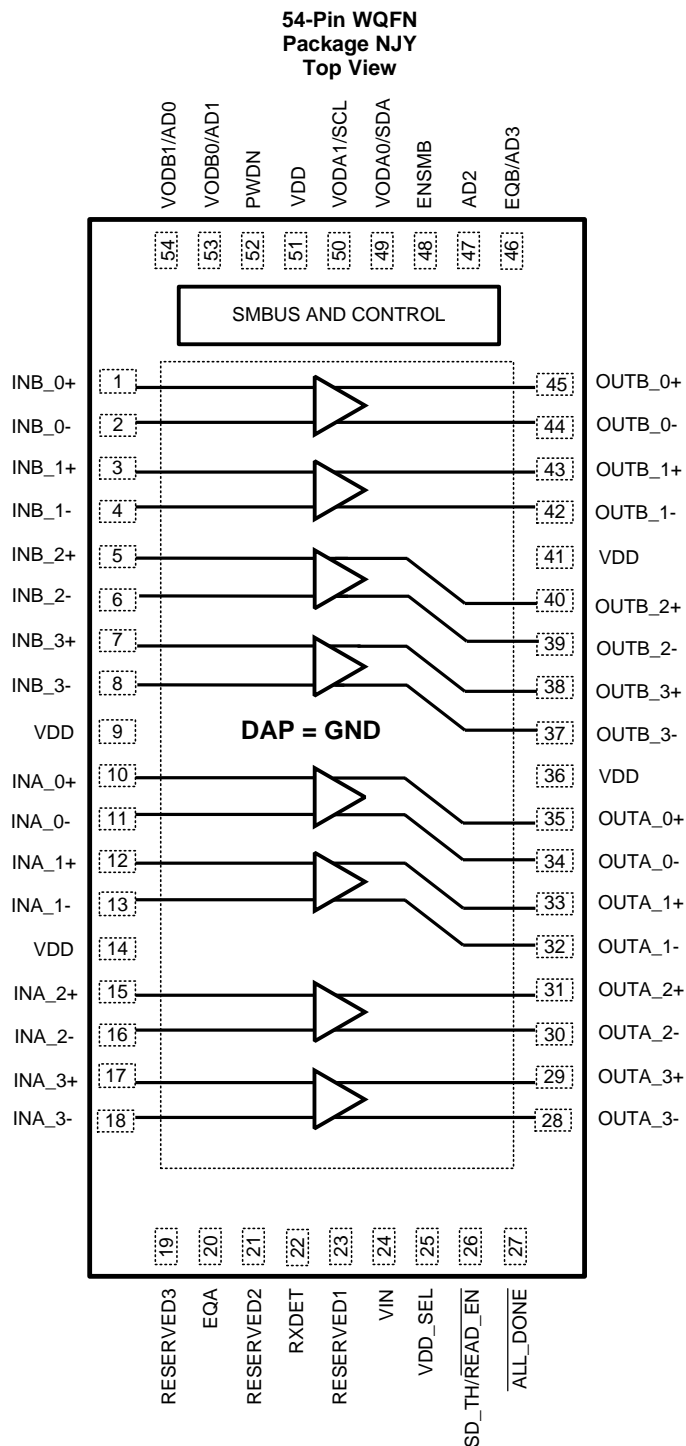

NOTE: Above 54-lead WQFN graphic is a TOP VIEW, looking down through the package.

Pin Functions⁽¹⁾

PIN NAME	PIN NUMBER	I/O, TYPE	DESCRIPTION
DIFFERENTIAL HIGH SPEED I/O			
INB_0+, INB_0-, INB_1+, INB_1-, INB_2+, INB_2-, INB_3+, INB_3-	1, 2 3, 4 5, 6 7, 8	I, CML	Inverting and non-inverting CML differential inputs to the equalizer. On-chip 50 Ω termination resistor connects INB_n+ to VDD and INB_n- to VDD depending on the state of RXDET. See Table 2 . AC coupling required on high-speed I/O
OUTB_0+, OUTB_0-, OUTB_1+, OUTB_1-, OUTB_2+, OUTB_2-, OUTB_3+, OUTB_3-	45, 44 43, 42 40, 39 38, 37	O, CML	Inverting and non-inverting 50 Ω driver outputs. Compatible with AC coupled CML inputs. AC coupling required on high-speed I/O
INA_0+, INA_0-, INA_1+, INA_1-, INA_2+, INA_2-, INA_3+, INA_3-	10, 11 12, 13 15, 16 17, 18	I, CML	Inverting and non-inverting CML differential inputs to the equalizer. On-chip 50 Ω termination resistor connects INA_n+ to VDD and INA_n- to VDD depending on the state of RXDET. See Table 2 . AC coupling required on high-speed I/O
OUTA_0+, OUTA_0-, OUTA_1+, OUTA_1-, OUTA_2+, OUTA_2-, OUTA_3+, OUTA_3-	35, 34 33, 32 31, 30 29, 28	O, CML	Inverting and non-inverting 50 Ω driver outputs. Compatible with AC coupled CML inputs. AC coupling required on high-speed I/O
CONTROL PINS — SHARED (LVCMOS)			
ENSMB	48	I, 4-LEVEL, LVCMOS	System Management Bus (SMBus) Enable Pin Tie 1 kΩ to VDD (2.5 V mode) or VIN (3.3 V mode) = Register Access SMBus Slave Mode FLOAT = Read External EEPROM (SMBus Master Mode) Tie 1 kΩ to GND = Pin Mode
ENSMB = 1 (SMBus SLAVE MODE)			
SCL	50	I, LVCMOS, O, OPEN Drain	In SMBus Slave Mode, this pin is the SMBus clock I/O. Clock input or open drain output. External 2 kΩ to 5 kΩ pull-up resistor required as per SMBus interface standards ⁽²⁾
SDA	49	I, LVCMOS, O, OPEN Drain	In both SMBus Modes, this pin is the SMBus data I/O. Data input or open drain output. External 2 kΩ to 5 kΩ pull-up resistor required as per SMBus interface standards ⁽²⁾
AD0-AD3	54, 53, 47, 46	I, LVCMOS	SMBus Slave Address Inputs. In both SMBus Modes, these pins are the user set SMBus slave address inputs. External 1 kΩ pull-up or pull-down recommended. Note: In Pin Mode, AD2 must be tied via external 1 kΩ to GND.
RESERVED2	21	I, 4-LEVEL, LVCMOS	Reserved For applications requiring Signal Detect status register read-back: <ul style="list-style-type: none"> • Leave Pin 21 floating. • Write Reg 0x08[2] = 1 if Pin 21 is floating. Otherwise, tie Pin 21 via external 1 kΩ to GND (External 1 kΩ to VDD (2.5 V mode) or VIN (3.3 V mode) is also acceptable).
RESERVED3	19	I, 4-LEVEL, LVCMOS	Reserved This input may be left floating, tied via 1 kΩ to VDD (2.5 V mode) or VIN (3.3 V mode), or tied via 1 kΩ to GND.

(1) LVCMOS inputs without the "Float" conditions must be driven to a logic low or high at all times or operation is not ensured.

Input edge rate for LVCMOS/FLOAT inputs must be faster than 50 ns from 10–90%.

For 3.3 V mode operation, VIN pin input = 3.3 V and the logic "1" or "high" reference for the 4-level input is 3.3 V.

For 2.5 V mode operation, VDD pin output = 2.5 V and the logic "1" or "high" reference for the 4-level input is 2.5 V.

(2) SCL and SDA pins can be tied either to 3.3 V or 2.5 V, regardless of whether the device is operating in 2.5 V mode or 3.3 V mode.

Pin Functions⁽¹⁾ (continued)

PIN NAME	PIN NUMBER	I/O, TYPE	DESCRIPTION
ENSMB = Float (SMBus MASTER MODE)			
SCL	50	I, LVCMOS, O, OPEN Drain	Clock output when loading EEPROM configuration, reverting to SMBus clock input when EEPROM load is complete (ALL_DONE = 0). External 2 kΩ to 5 kΩ pull-up resistor required as per SMBus interface standards ⁽²⁾
SDA	49	I, LVCMOS, O, OPEN Drain	In both SMBus Modes, this pin is the SMBus data I/O. Data input or open drain output. External 2 kΩ to 5 kΩ pull-up resistor required as per SMBus interface standards ⁽²⁾
AD0-AD3	54, 53, 47, 46	I, LVCMOS	SMBus Slave Address Inputs. In both SMBus Modes, these pins are the user set SMBus slave address inputs. External 1 kΩ pull-up or pull-down recommended. Note: In Pin Mode, AD2 must be tied via external 1 kΩ to GND.
READ_EN	26	I, LVCMOS	A logic low on this pin starts the load from the external EEPROM ⁽³⁾ . Once EEPROM load is complete (ALL_DONE = 0), this pin functionality remains as READ_EN. It does not revert to an SD_TH input.
RESERVED2	21	I, 4-LEVEL, LVCMOS	Reserved For applications requiring Signal Detect status register read-back: <ul style="list-style-type: none"> • Leave Pin 21 floating. • Write Reg 0x08[2] = 1 if Pin 21 is floating. Otherwise, tie Pin 21 via external 1 kΩ to GND (External 1 kΩ to VDD (2.5 V mode) or VIN (3.3 V mode) is also acceptable).
RESERVED3	19	I, 4-LEVEL, LVCMOS	Reserved This input may be left floating, tied via 1 kΩ to VDD (2.5 V mode) or VIN (3.3 V mode), or tied via 1 kΩ to GND.
ENSMB = 0 (PIN MODE)			
EQA EQB	20 46	I, 4-LEVEL, LVCMOS	EQA and EQB pins control the level of equalization for the A-channels and B-channels, respectively. The pins are defined as EQA and EQB only when ENSMB is de-asserted (low). Each of the four A-channels have the same level unless controlled by the SMBus control registers. Likewise, each of the four B-channels have the same level unless controlled by the SMBus control registers. When the device operates in Slave or Master Mode, the SMBus registers independently control each lane, and the EQB pin is converted to an AD3 input. See Table 4 .
VODB0 VODB1	53 54	I, 4-LEVEL, LVCMOS	VODB[1:0] controls the output amplitude of the B-channels. The pins are defined as VODB[1:0] only when ENSMB is de-asserted (low). Each of the four B-channels have the same level unless controlled by the SMBus control registers. When the device operates in Slave or Master Mode, the SMBus registers provide independent control of each lane, and VODB[1:0] pins are converted to AD0, AD1 inputs. See Table 5 .
VODA0 VODA1	49 50	I, 4-LEVEL, LVCMOS	VODA[1:0] controls the output amplitude of the A-channels. The pins are defined as VODA[1:0] only when ENSMB is de-asserted (low). Each of the four A-channels have the same level unless controlled by the SMBus control registers. When the device operates in Slave or Master Mode, the SMBus registers provide independent control of each lane and the VODA[1:0] pins are converted to SCL and SDA. See Table 5 .
AD2	47	I, LVCMOS	Reserved in Pin Mode (ENSMB = 0) This input must be tied via external 1 kΩ to GND.
SD_TH	26	I, 4-LEVEL, LVCMOS	Controls the internal Signal Detect Status Threshold value when in Pin Mode and SMBus Slave Mode. This pin is to be used for system debugging only, as the signal detect threshold has no impact on the data path. See Table 3 for more information. For final designs, input can be left floating, tied via 1 kΩ to VDD (2.5 V mode) or VIN (3.3 V mode), or tied via 1 kΩ to GND.
RESERVED2	21	I, 4-LEVEL, LVCMOS	Reserved Tie via external 1 kΩ to GND (External 1 kΩ to VDD (2.5 V mode) or VIN (3.3 V mode) is also acceptable).

(3) When READ_EN is asserted low, the device attempts to load EEPROM. If EEPROM cannot be loaded successfully, for example due to an invalid or blank hex file, the DS80PCI810 waits indefinitely in an unknown state where SMBus access is not possible. ALL_DONE pin remains high in this situation.

Pin Functions⁽¹⁾ (continued)

PIN NAME	PIN NUMBER	I/O, TYPE	DESCRIPTION
RESERVED3	19	I, 4-LEVEL, LVCMOS	Reserved This input must be tied via external 1 kΩ to GND.
CONTROL PINS — BOTH PIN AND SMBUS MODES (LVCMOS)			
RXDET	22	I, 4-LEVEL, LVCMOS	The RXDET pin controls the RX detection function. Depending on the input level, a 50 Ω or >50 kΩ termination to the power rail is enabled. Keep this input floating for normal PCIe operation. See Table 2 .
RESERVED1	23	I, 4-LEVEL, LVCMOS	Reserved This input must be left floating.
VDD_SEL	25	I, FLOAT	Controls the internal regulator Float = 2.5 V mode Tie to GND = 3.3 V mode See Figure 31 .
PWDN	52	I, LVCMOS	Tie High = Low power - Power Down Tie to GND = Normal Operation See Table 2 .
<u>ALL_DONE</u>	27	O, LVCMOS	Valid Register Load Status Output HIGH = External EEPROM load failed or incomplete LOW = External EEPROM load passed
POWER			
VIN	24	Power	In 3.3 V mode, feed 3.3 V to VIN In 2.5 V mode, leave floating.
VDD	9, 14, 36, 41, 51	Power	Power Supply for CML and Analog Pins In 2.5 V mode, connect to 2.5 V In 3.3 V mode, connect 0.1 μF cap to each VDD Pin and GND See Figure 31 for proper power supply decoupling .
GND	DAP	Power	Ground pad (DAP - die attach pad).

6 Specifications

6.1 Absolute Maximum Ratings⁽¹⁾

over operating free-air temperature range (unless otherwise noted)

		MIN	MAX	UNIT
Supply Voltage (VDD to GND, 2.5 V Mode)		-0.5	+2.75	V
Supply Voltage (VIN to GND, 3.3 V Mode)		-0.5	+4.0	V
LVCMOS Input/Output Voltage		-0.5	+4.0	V
CML Input Voltage		-0.5	VDD + 0.5	V
CML Input Current		-30	+30	mA
Storage temperature, T _{stg}		-40	125	°C
T _{solder}	Lead Temperature Range Soldering (4 sec.) ⁽²⁾		260	°C

- (1) "Absolute Maximum Ratings" indicate limits beyond which damage to the device may occur, including inoperability and degradation of device reliability and performance. Functional operation of the device and/or non-degradation at the Absolute Maximum Ratings or other conditions beyond those indicated in the Recommended Operating Conditions is not implied. The Recommended Operating Conditions indicate conditions at which the device is functional and the device should not be operated beyond such conditions. Absolute Maximum Numbers are ensured for a junction temperature range of -40°C to +125°C. Models are validated to Maximum Operating Voltages only.
- (2) For soldering specifications: See application note [SNOA549](#).

6.2 ESD Ratings

		VALUE	UNIT
V _(ESD)	Electrostatic discharge		V
	Human-body model (HBM), per ANSI/ESDA/JEDEC JS-001 ⁽¹⁾	±4000	
	Charged-device model (CDM), per JEDEC specification JESD22-C101 ⁽²⁾	±1000	

- (1) JEDEC document JEP155 states that 500-V HBM allows safe manufacturing with a standard ESD control process. Manufacturing with less than 500-V HBM is possible with the necessary precautions. Pins listed as ±4000 V may actually have higher performance.
- (2) JEDEC document JEP157 states that 250-V CDM allows safe manufacturing with a standard ESD control process. Manufacturing with less than 250-V CDM is possible with the necessary precautions. Pins listed as ±1000 V may actually have higher performance.

6.3 Handling Ratings

		MIN	MAX	UNIT	
V _(ESD)	Electrostatic discharge	Human body model (HBM), per ANSI/ESDA/JEDEC JS-001, all pins ⁽¹⁾	-4000	4000	V
		Charged device model (CDM), per JEDEC specification JESD22-C101, all pins ⁽²⁾	-1000	1000	

- (1) JEDEC document JEP155 states that 4000-V HBM allows safe manufacturing with a standard ESD control process.
- (2) JEDEC document JEP157 states that 1000-V CDM allows safe manufacturing with a standard ESD control process.

6.4 Recommended Operating Conditions

over operating free-air temperature range (unless otherwise noted)

	MIN	NOM	MAX	UNIT
Supply Voltage (2.5 V mode) ⁽¹⁾	2.375	2.5	2.625	V
Supply Voltage (3.3 V mode) ⁽¹⁾	3.0	3.3	3.6	V
Ambient Temperature	-40		+85	°C
SMBus (SDA, SCL)			3.6	V
Supply Noise up to 50 MHz ⁽²⁾		100		mVp-p

- (1) DC plus AC power should not exceed these limits.
- (2) Allowed supply noise (mVp-p sine wave) under typical conditions.

6.5 Thermal Information

THERMAL METRIC ⁽¹⁾		NJY	UNIT
		54 PINS	
R _{θJA}	Junction-to-ambient thermal resistance	26.6	°C/W
R _{θJctop}	Junction-to-case (top) thermal resistance	10.8	
R _{θJB}	Junction-to-board thermal resistance	4.4	
Ψ _{JT}	Junction-to-top characterization parameter	0.2	
Ψ _{JB}	Junction-to-board characterization parameter	4.3	
R _{θJcbot}	Junction-to-case (bottom) thermal resistance	1.5	

(1) For more information about traditional and new thermal metrics, see the *IC Package Thermal Metrics* application report, [SPRA953](#).

6.6 Electrical Characteristics

PARAMETER		TEST CONDITIONS	MIN	TYP	MAX	UNIT
POWER						
I _{DD}	Current Consumption, 2.5 V Mode	EQ = Level 4, VOD = Level 6 RXDET = 1, PWDN = 0		220	280	mA
	Current Consumption, 3.3 V Mode	EQ = Level 4, VOD = Level 6 RXDET = 1, PWDN = 0		220	280	mA
	Power Down Current Consumption	PWDN = 1		14	27	mA
V _{DD}	Integrated LDO Regulator	V _{IN} = 3.0 - 3.6 V	2.375	2.5	2.625	V
LVC MOS / LV TTL DC SPECIFICATIONS						
V _{IH25}	High Level Input Voltage	2.5 V Supply Mode	1.7		V _{DD}	V
V _{IH33}	High Level Input Voltage	3.3 V Supply Mode	1.7		V _{IN}	V
V _{IL}	Low Level Input Voltage		0		0.7	V
V _{OH}	High Level Output Voltage (ALL_DONE pin)	I _{OH} = -4mA	2.0			V
V _{OL}	Low Level Output Voltage (ALL_DONE pin)	I _{OL} = 4mA			0.4	V
I _{IH}	Input High Current (PWDN pin)	V _{IN} = 3.6 V, LVC MOS = 3.6 V	-15		+15	μA
I _{IL}	Input Low Current (PWDN pin)	V _{IN} = 3.6 V, LVC MOS = 0 V	-15		+15	μA
4-LEVEL INPUT DC SPECIFICATIONS						
I _{IH}	Input High Current with internal resistors (4-level input pin)	V _{IN} = 3.6 V, LVC MOS = 3.6 V	+20		+150	μA
I _{IL}	Input Low Current with internal resistors (4-level input pin)	V _{IN} = 3.6 V, LVC MOS = 0 V	-160		-40	μA
V _{TH}	Voltage Threshold from Pin Mode Level 0 to R	V _{DD} = 2.5 V (2.5 V supply mode) Internal LDO Disabled See Table 1 for details		0.50		V
	Voltage Threshold from Pin Mode Level R to F			1.25		
	Voltage Threshold from Pin Mode Level F to 1			2.00		
	Voltage Threshold from Pin Mode Level 0 to R	V _{IN} = 3.3 V (3.3 V supply mode) Internal LDO Enabled See Table 1 for details.		0.66		V
	Voltage Threshold from Pin Mode Level R to F			1.65		
	Voltage Threshold from Pin Mode Level F to 1			2.64		

Electrical Characteristics (continued)

PARAMETER		TEST CONDITIONS	MIN	TYP	MAX	UNIT
CML RECEIVER INPUTS (IN_{n+}, IN_{n-})						
Z _{Rx-DIFF-DC}	Rx DC differential mode impedance	Tested at VDD = 2.5 V	80	100	120	Ω
Z _{Rx-DC}	Rx DC single ended impedance	Tested at VDD = 2.5 V	40	50	60	Ω
RL _{Rx-DIFF}	Rx Differential Input return loss	SDD11 10 MHz		-19		dB
		SDD11 2 GHz		-14		
		SDD11 6-11.1 GHz		-8		
RL _{Rx-CM}	Rx Common mode return loss	SCC11 0.05 - 5 GHz		-10		dB
V _{Rx-ASSERT-DIFF-PP}	Signal detect assert level for active data signal	SD_TH = F (float), 1010 pattern at 12 Gbps		57		mVp-p
V _{Rx-DEASSERT-DIFF-PP}	Signal detect de-assert for inactive signal level	SD_TH = F (float), 1010 pattern at 12 Gbps		44		mVp-p
HIGH SPEED OUTPUTS						
RL _{Tx-DIFF}	Tx Differential return loss	SDD22 10 MHz - 2 GHz		-15		dB
		SDD22 5.5 GHz		-12		
		SDD22 11.1 GHz		-10		dB
RL _{Tx-CM}	Tx Common mode return loss	SCC22 50 MHz- 2.5 GHz		-8		dB
Z _{Tx-DIFF-DC}	DC differential Tx impedance			100		Ω
I _{Tx-SHORT}	Transmitter short circuit current limit	Total current when output is shorted to VDD or GND		20		mA
V _{Tx-CM-DC-LINE-DELTA}	Absolute delta of DC common mode voltage between Tx+ and Tx-				25	mV
V _{Tx-DIFF1-PP}	Output Voltage Differential Swing	Differential measurement with OUT _{n+} and OUT _{n-} , AC-Coupled and terminated by 50 Ω to GND, Inputs AC-Coupled, Measured with 8T Pattern at 12 Gbps ⁽¹⁾ VID = 600 mVp-p VOD = Level 6 ⁽²⁾⁽³⁾		615		mVp-p
V _{Tx-DIFF2-PP}	Output Voltage Differential Swing	Differential measurement with OUT _{n+} and OUT _{n-} , AC-Coupled and terminated by 50 Ω to GND, Inputs AC-Coupled, Measured with 8T Pattern at 12 Gbps ⁽¹⁾ VID = 1000 mVp-p VOD = Level 6 ⁽²⁾⁽³⁾		950		mVp-p
V _{Tx-DIFF3-PP}	Output Voltage Differential Swing	Differential measurement with OUT _{n+} and OUT _{n-} , AC-Coupled and terminated by 50 Ω to GND, Inputs AC-Coupled, Measured with 8T Pattern at 12 Gbps ⁽¹⁾ VID = 1200 mVp-p VOD = Level 6 ⁽²⁾⁽³⁾		1100		mVp-p

(1) 8T pattern is defined as a 1111111100000000'b pattern bit sequence.

(2) ATE measurements for production are tested at DC.

(3) In PCIe applications, the output VOD level is not fixed. It adjusts automatically based on the VID input amplitude level. The output VOD level set by VODA/B[1:0] depends on the VID level and the frequency content. The DS80PCI810 repeater is designed to be transparent in this mode, so the Tx-FIR (de-emphasis) is passed to the Rx to support the handshake negotiation link training.

Electrical Characteristics (continued)

PARAMETER		TEST CONDITIONS	MIN	TYP	MAX	UNIT
T _{PDEQ}	Differential propagation delay	EQ = Level 1 to Level 4		80		ps
V _{Tx-CM-AC-PP}	AC common mode voltage	EQ = Level 4, VOD = Level 6, PRBS-7, 8 Gbps Measured over >10 ⁶ bits using a low pass filter with a -3 dB corner frequency at 4 GHz ⁽⁴⁾		20		mVp-p
V _{DISABLE-OUT}	Tx disable output voltage	Driver disabled via PWDN		1		mVp-p
V _{Tx-IDLE-DIFF-AC-P}	Tx idle differential peak output voltage	Driver enabled, EQ = Level 4, VOD = Level 7 (Max) ⁽⁵⁾		8		mV
T _{Tx-IDLE-SET-TO-IDLE}	Time to transition to idle after differential signal	VID = 1.0 Vp-p, 1.5 Gbps		0.70		ns
T _{Tx-IDLE-TO-DIFF-DATA}	Time to transition to valid differential signal after idle	VID = 1.0 Vp-p, 1.5 Gbps		0.04		ns
RJ _{ADD}	Additive Random Jitter	Evaluation Module (EVM) Only, FR4, VID = 800 mVp-p, EQ = Level 1 PRBS15, 12 Gbps VOD = Level 6 All other channels active ⁽⁶⁾		0.36		ps rms
EQUALIZATION						
DJE1	Residual deterministic jitter at 6 Gbps	5" Differential Stripline, 5mil trace width, FR4, VID = 800 mVp-p, PRBS15, EQ = Level 2, VOD = Level 6		0.06		Ulp-p
DJE2	Residual deterministic jitter at 12 Gbps	5" Differential Stripline, 5mil trace width, FR4, VID = 800 mVp-p, PRBS15, EQ = Level 2, VOD = Level 6		0.12		Ulp-p

(4) Tx Common Mode AC noise decreases at lower levels of EQ gain.

(5) Tested with a valid idle signal on the input with peak differential voltage of 6 mV.

(6) Additive random jitter is given in RMS value by the following equation: $RJ_{ADD} = \sqrt{[(Output\ Jitter)^2 - (Input\ Jitter)^2]}$. Typical input jitter for these measurements is 150 fs rms.

6.7 Electrical Characteristics — Serial Management Bus Interface

Over recommended operating supply and temperature ranges unless other specified.

PARAMETER		TEST CONDITIONS	MIN	TYP	MAX	UNIT
SERIAL BUS INTERFACE DC SPECIFICATIONS						
V _{IL}	Data, Clock Input Low Voltage				0.8	V
V _{IH}	Data, Clock Input High Voltage		2.1		3.6	V
V _{OL}	Output Low Voltage	SDA or SCL, I _{OL} = 1.25 mA	0		0.36	V
V _{DD}	Nominal Bus Voltage		2.375		3.6	V
I _{IH-Pin}	Input Leakage Per Device Pin		+20		+150	μA
I _{IL-Pin}	Input Leakage Per Device Pin		-160		-40	μA
C _I	Capacitance for SDA and SCL	See ⁽¹⁾⁽²⁾		< 5		pF
R _{TERM}	External Termination Resistance pull to V _{DD} = 2.5 V ± 5% OR 3.3 V ± 10%	Pullup V _{DD} = 3.3 V ⁽¹⁾⁽²⁾⁽³⁾		2000		Ω
		Pullup V _{DD} = 2.5 V ⁽¹⁾⁽²⁾⁽³⁾		1000		Ω

(1) Recommended value.

(2) Recommended maximum capacitance load per bus segment is 400 pF.

(3) Maximum termination voltage should be identical to the device supply voltage.

6.8 Timing Requirements Serial Bus Interface

PARAMETER		TEST CONDITIONS	MIN	TYP	MAX	UNIT
SERIAL BUS INTERFACE TIMING SPECIFICATIONS						
F _{SMB}	Bus Operating Frequency	ENSMB = VDD (Slave Mode)			400	kHz
		ENSMB = FLOAT (Master Mode)	280	400	520	kHz
t _{FALL}	SCL or SDA Fall Time	Read operation RPU = 4.7 kΩ, C _b < 50 pF		60		ns
t _{RISE}	SCL or SDA Rise Time	Read operation RPU = 4.7 kΩ, C _b < 50 pF		140		ns
t _F	Clock/Data Fall Time	See ⁽¹⁾			300	ns
t _R	Clock/Data Rise Time	See ⁽¹⁾			1000	ns
t _{POR}	Time in which a device must be operational after power-on reset	See ⁽¹⁾			500	ms

(1) Compliant to SMBus 2.0 physical layer specification. See System Management Bus (SMBus) Specification Version 2.0, section 3.1.1 SMBus common AC specifications for details.

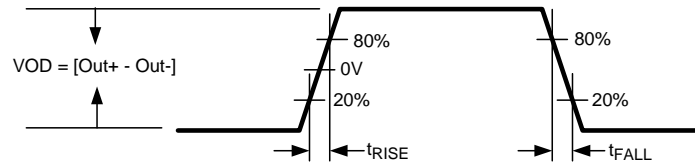

Figure 1. Output Rise And Fall Transition Time

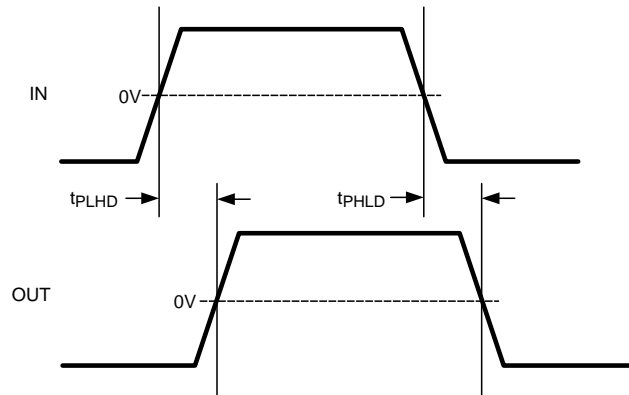

Figure 2. Propagation Delay Timing Diagram

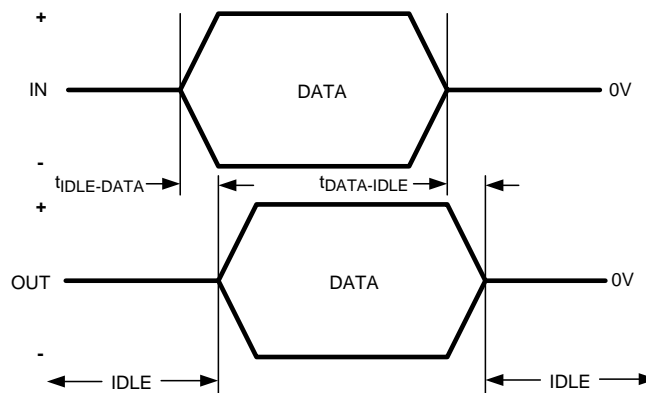

Figure 3. Transmit Idle-Data and Data-Idle Response Time

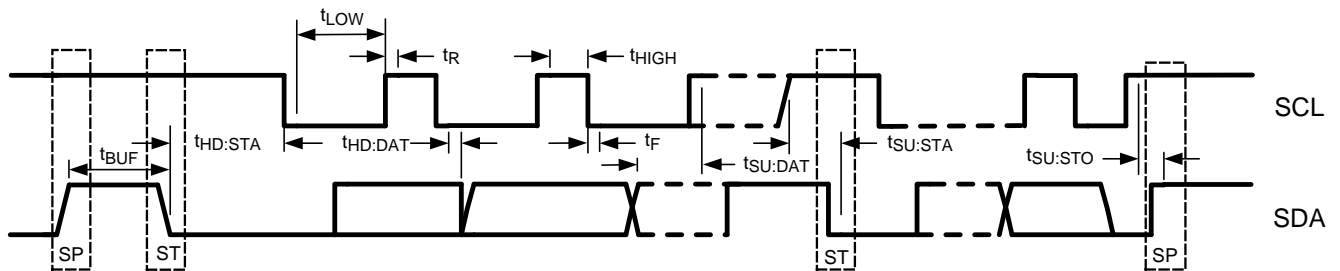
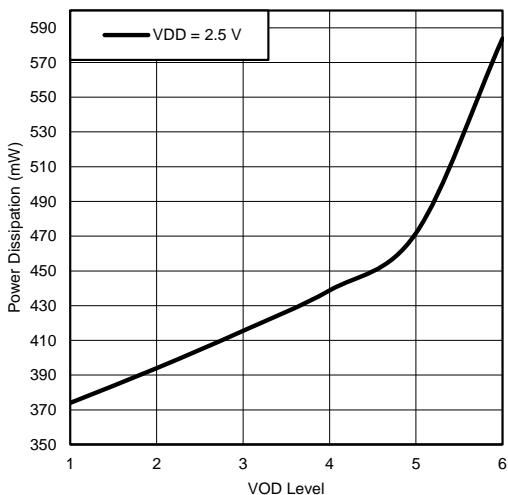

Figure 4. SMBus Timing Parameters

6.9 Typical Characteristics



Test Conditions
 EQ Level 4
 VOD_DB 000'b
 T 25°C

Figure 5. Typical Power Dissipation vs. VOD

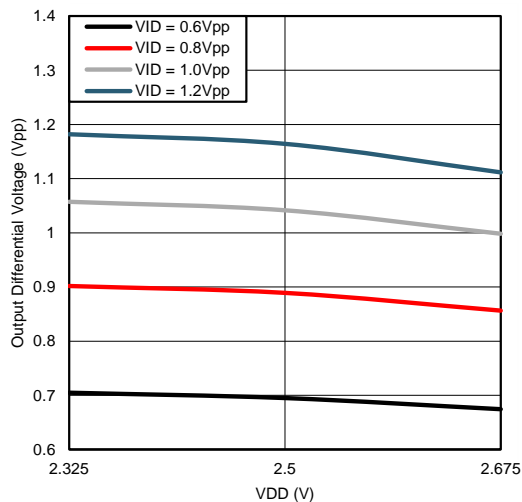

Test Conditions
 Data Rate, Test Pattern 1.5625 Gbps, 1010 Pattern
 VOD Level 6
 EQ Level 1
 T 25°C

Figure 6. Typical VOD vs. VDD

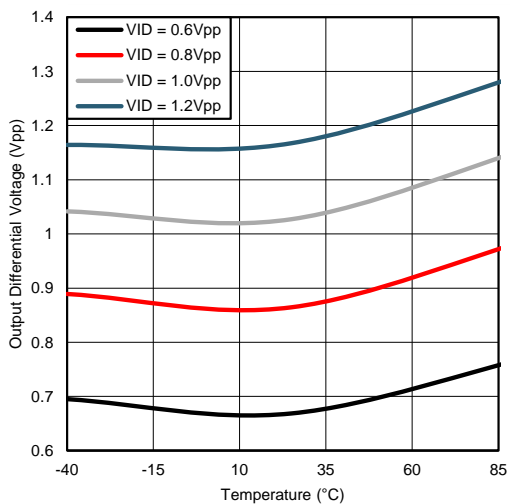

Test Conditions
 Data Rate, Test Pattern 1.5625 Gbps, 1010 Pattern
 VOD Level 6
 EQ Level 1
 VDD 2.5 V

Figure 7. Typical VOD vs. Temperature

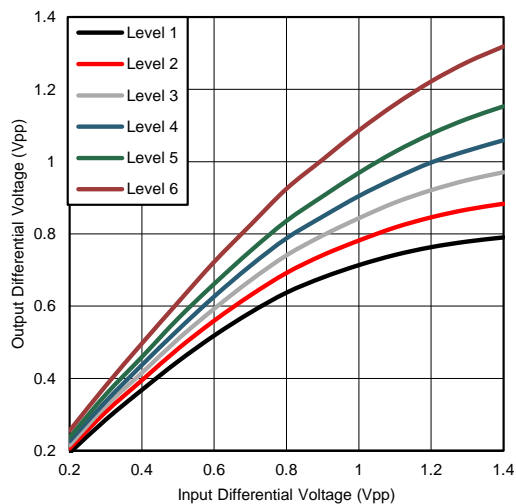

Test Conditions
 Data Rate, Test Pattern 1.5625 Gbps, 1010 Pattern
 EQ Level 1
 T 25°C
 VDD 2.5 V

Figure 8. Typical VOD vs. VID

7 Detailed Description

7.1 Overview

The DS80PCI810 provides linear equalization for lossy printed circuit board backplanes and balanced cables. The DS80PCI810 operates in three modes: Pin Control Mode (ENSMB = 0), SMBus Slave Mode (ENSMB = 1), and SMBus Master Mode (ENSMB = Float) to load register information from external EEPROM.

7.2 Functional Block Diagram

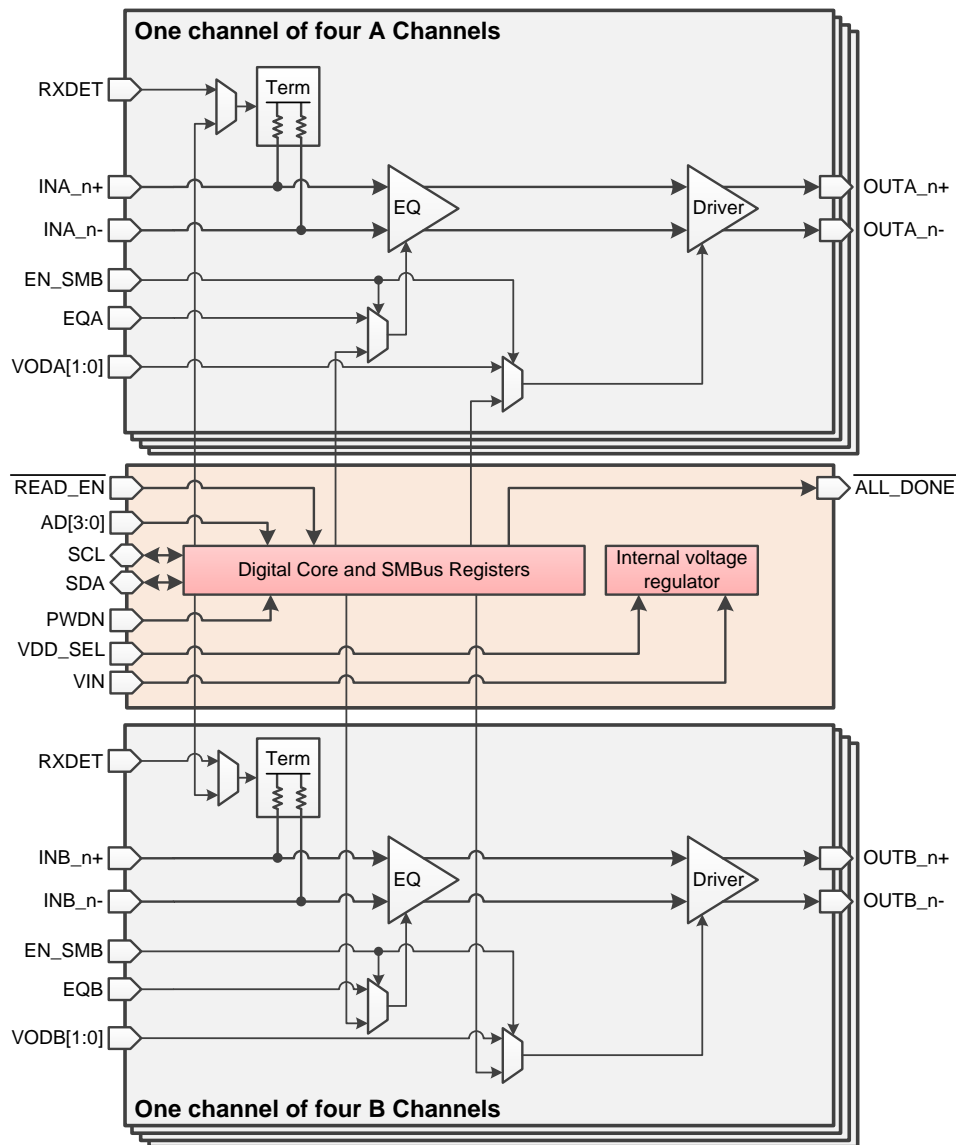

7.2.1 Functional Datapath Blocks

In an increasing number of high speed applications, transparency between Tx and Rx endpoints is essential to ensure high signal integrity. The DS80PCI810 channel datapath uses one gain stage input equalization coupled with a linear output driver. This combination provides a high level of transparency, thereby achieving greater drive distance in PCIe applications where Rx-Tx auto-negotiation and link-training are required. Refer to the [Typical Applications](#) section for more application information regarding recommended settings and placement.

7.3 Feature Description

The 4-level input pins use a resistor divider to set the four valid control levels and provide a wider range of control settings when ENSMB = 0. There is an internal 30 kΩ pull-up and a 60 kΩ pull-down connected to the package pin. These resistors, together with the external resistor connection, combine to achieve the desired voltage level. By using the 1 kΩ pull-down, 20 kΩ pull-down, no connect, and 1 kΩ pull-up, the optimal voltage levels for each of the four input states are achieved as shown in [Table 1](#).

Table 1. 4-Level Control Pin Settings

LEVEL	SETTING	Resulting Pin Voltage	
		3.3-V MODE	2.5-V MODE
0	Tie 1 kΩ to GND	0.10 V	0.08 V
R	Tie 20 kΩ to GND	$1/3 \times V_{IN}$	$1/3 \times V_{DD}$
F	Float (leave pin open)	$2/3 \times V_{IN}$	$2/3 \times V_{DD}$
1	Tie 1 kΩ to V_{IN} or V_{DD}	$V_{IN} - 0.05 \text{ V}$	$V_{DD} - 0.04 \text{ V}$

7.3.1 Typical 4-Level Input Thresholds

- Internal Threshold between 0 and R = $0.2 \times V_{IN}$ or V_{DD}
- Internal Threshold between R and F = $0.5 \times V_{IN}$ or V_{DD}
- Internal Threshold between F and 1 = $0.8 \times V_{IN}$ or V_{DD}

In order to minimize the startup current associated with the integrated 2.5 V regulator, the 1 kΩ pull-up / pull-down resistors are recommended. If several 4-level inputs require the same setting, it is possible to combine two or more 1 kΩ resistors into a single lower value resistor. As an example, combining two inputs with a single 500 Ω resistor is a valid way to save board space.

7.4 Device Functional Modes

7.4.1 Pin Control Mode:

When in Pin Mode (ENSMB = 0), equalization and VOD (output amplitude) can be selected via pin control for both the A-channels and B-channels per [Table 4](#) and [Table 5](#). The RXDET pin provides either automatic or manual control for input termination (50 Ω or > 50 kΩ to VDD). The receiver electrical signal detect status threshold is adjustable via the SD_TH pin. By setting signal-detect threshold level via the SD_TH pin, status information about a valid signal detect assert/de-assert can be read back via SMBus registers. Pin control mode is ideal in situations where neither MCU or EEPROM is available to access the device via SMBus SDA/SCL lines.

7.4.2 Slave SMBus Mode:

When in Slave SMBus Mode (ENSMB = 1), the VOD (output amplitude), equalization, and termination disable features are all programmable on an individual channel basis, rather than in collective A-channel and B-channel groups. Upon assertion of ENSMB, the EQx and VODx settings are controlled by SMBus immediately. It is important to note that SMBus settings can only be changed from their defaults after asserting Register Enable by setting Reg 0x06[3] = 1. The EQx and VODx pins are subsequently converted to AD0-AD3 SMBus address inputs. The other external control pins (RXDET and SD_TH) remain active unless their respective registers are written to and the appropriate override bit is set. If the user overrides a pin control, the input voltage level of that control pin is ignored until ENSMB is driven low (Pin Mode). In the event that channels are powered down via the PWDN pin, the state of all register settings are not affected.

Device Functional Modes (continued)

Table 2. RX Detect Settings

PWDN ⁽¹⁾ (Pin 52)	RXDET (Pin 22)	SMBus REG Bit[3:2]	INPUT TERMINATION	RECOMMENDED USE	COMMENTS
0	0	00	Hi-Z		Manual Rx-Detect, input is Hi-Z
0	R	01	Pre Detect: Hi-Z Post Detect: 50 Ω	PCIe	Auto Rx-Detect, outputs test every 12 ms for 600 ms then stops; termination is Hi-Z until Rx detection; once detected input termination is 50 Ω. Reset function by pulsing PWDN high for 5 μs then low again
0	F (Default)	10	Pre Detect: Hi-Z Post Detect: 50 Ω	PCIe	Auto Rx-Detect, outputs test every 12 ms until detection occurs; termination is Hi-Z until Rx detection; once detected input termination is 50 Ω
0	1	11	50 Ω		Manual Rx-Detect, input is 50 Ω
1	X	X	Hi-Z		Power Down mode, input is Hi-Z, output drivers are disabled Used to reset Rx-Detect State Machine when held high for 5 μs

(1) In SMBus Slave Mode, the Rx Detect State Machine can be manually reset in software by overriding the device $\overline{\text{PRSNT}}$ function. This is accomplished by setting the Override $\overline{\text{PRSNT}}$ bit (Reg 0x02[7]) and then toggling the $\overline{\text{PRSNT}}$ value bit (Reg 0x02[6]). See Table 9 for more information about resetting the Rx Detect State Machine.

Table 3. Signal Detect Status Threshold Level⁽¹⁾⁽²⁾

LEVEL	SD_TH (PIN 26)	SMBus REG BIT[3:2] and[1:0]	[3:2] ASSERT LEVEL (mVp-p)		[1:0] DE-ASSERT LEVEL (mVp-p)	
			3 Gbps	12 Gbps	3 Gbps	12 Gbps
1	0	10	18	75	14	55
2	R	01	12	40	8	22
3	F (default)	00	15	50	11	37
4	1	11	16	58	12	45

(1) VDD = 2.5 V, 25°C, 1010 pattern at 1.5 Gbps and 101010 pattern at 12 Gbps

(2) Signal detect status threshold sets the value at which a signal detect status is flagged via SMBus Reg 0x0A. Regardless of the threshold level, the output always remains enabled unless manually powered down.

7.4.3 SMBus Master Mode

When in SMBus Master Mode ($\overline{\text{ENSMB}} = \text{Float}$), the VOD (output amplitude), equalization, and termination disable features for multiple devices can be loaded via external EEPROM. By asserting a Float condition on the $\overline{\text{ENSMB}}$ pin, an external EEPROM writes register settings to each device in accordance with its SMBus slave address. The settings programmable by external EEPROM provide only a subset of all the register bits available via SMBus Slave Mode, and the bit-mapping between SMBus Slave Mode registers and EEPROM addresses can be referenced in Table 6. Once the EEPROM successfully finishes loading each device's register settings, the device reverts back to SMBus Slave Mode and releases SDA/SCL control to an external master MCU. If the EEPROM fails to load settings to a particular device, for example due to an invalid or blank hex file, the device waits indefinitely in an unknown state where access to the SMBus lines is not possible.

7.4.4 Signal Conditioning Settings

Equalization and VOD settings accessible via the pin controls are chosen to meet the needs of most high speed applications. These settings can also be controlled via the SMBus registers. Each pin input has a total of four possible voltage level settings. Table 4 and Table 5 show both the Pin Mode and SMBus Mode settings that are used in order to program the equalization and VOD gain for each DS80PCI810 channel.

Table 4. Equalizer Settings⁽¹⁾⁽²⁾

EQUALIZATION BOOST RELATIVE TO DC					
LEVEL	EQA ⁽³⁾ EQB	EQ – 8 bits[7:0]	dB at 1.5 GHz	dB at 2.5 GHz	dB at 4 GHz
1	0	xxxx xx00 = 0x00	2.1	2.5	2.7
2	R	xxxx xx01 = 0x01	4.0	5.1	6.4
3	F	xxxx xx10 = 0x02	5.5	7.0	8.3
4	1	xxxx xx11 = 0x03	6.8	8.3	9.5

- (1) Optimal EQ setting should be determined via simulation and prototype verification.
(2) Equalization boost values are inclusive of package loss.
(3) To program EQ Level 1-4 correctly in Pin Mode, RESERVED3 and AD2 pins must be tied via 1 kΩ resistor to GND.

Table 5. Output Voltage Settings⁽¹⁾

LEVEL	VODA1 VODB1	VODA0 VODB0	VOD - 3 bits[2:0]	VOD_DB - 3 bits[2:0]	VID Vp-p	VOD/VID Ratio ⁽¹⁾
--	--	--	000'b	000'b	1.2	0.57 ⁽²⁾
1	0	0	001'b	000'b	1.2	0.65
2	0	R	010'b	000'b	1.2	0.71
3	0	1	011'b	000'b	1.2	0.77
4	R	F	100'b	000'b	1.2	0.83
5	F	R	101'b	000'b	1.2	0.90
6	1	0	110'b	000'b	1.2	1.00
--	--	--	111'b	000'b	1.2	1.04 ⁽²⁾⁽³⁾

- (1) For PCIe operation, it is important to keep the output amplitude and dynamic range as large as possible. When operating in Pin Mode, it is recommended to use VODA[1:0] = VODB[1:0] = Level 6. In SMBus Mode, it is also recommended to use Level 6 (that is, VOD = 110'b and VOD_DB = 000'b).
(2) These VOD settings are only accessible via SMBus Modes.
(3) VOD = 111'b setting in SMBus Mode is not recommended.

Table 6. EEPROM Address Map - Single Device With Default Value

EEPROM Address Byte		Bit 7	Bit 6	Bit 5	Bit 4	Bit 3	Bit 2	Bit 1	Bit 0
Description	0x00	CRC_EN	Address Map Present	EEPROM > 256 Bytes	Reserved	DEVICE COUNT[3]	DEVICE COUNT[2]	DEVICE COUNT[1]	DEVICE COUNT[0]
Default Value		0	0	0	0	0	0	0	0
Description	0x01	Reserved	Reserved	Reserved	Reserved	Reserved	Reserved	Reserved	Reserved
Default Value		0	0	0	0	0	0	0	0
Description	0x02	Max EEPROM Burst size[7]	Max EEPROM Burst size[6]	Max EEPROM Burst size[5]	Max EEPROM Burst size[4]	Max EEPROM Burst size[3]	Max EEPROM Burst size[2]	Max EEPROM Burst size[1]	Max EEPROM Burst size[0]
Default Value		0	0	0	0	0	0	0	0
Description	0x03	PWDN_CH7	PWDN_CH6	PWDN_CH5	PWDN_CH4	PWDN_CH3	PWDN_CH2	PWDN_CH1	PWDN_CH0
SMBus Register		0x01[7]	0x01[6]	0x01[5]	0x01[4]	0x01[3]	0x01[2]	0x01[1]	0x01[0]
Default Value		0	0	0	0	0	0	0	0
Description	0x04	Reserved	Reserved	Reserved	Reserved	Ovrd_PWDN	Reserved	Reserved	Reserved
SMBus Register		0x02[5]	0x02[4]	0x02[3]	0x02[2]	0x02[0]	0x04[7]	0x04[6]	0x04[5]
Default Value		0	0	0	0	0	0	0	0
Description	0x05	Reserved	Reserved	Reserved	Reserved	Reserved	Reserved	Ovrd_SD_TH	Reserved
SMBus Register		0x04[4]	0x04[3]	0x04[2]	0x04[1]	0x04[0]	0x06[4]	0x08[6]	0x08[5]
Default Value		0	0	0	0	0	1	0	0
Description	0x06	Reserved	Ovrd_RXDET	Reserved	Reserved	Reserved	Reserved	Reserved	Reserved
SMBus Register		0x08[4]	0x08[3]	0x08[2]	0x08[1]	0x08[0]	0x0B[6]	0x0B[5]	0x0B[4]
Default Value		0	0	0	0	0	1	1	1
Description	0x07	Reserved	Reserved	Reserved	Reserved	Reserved	Reserved	CH0_RXDET_1	CH0_RXDET_0
SMBus Register		0x0B[3]	0x0B[2]	0x0B[1]	0x0B[0]	0x0E[5]	0x0E[4]	0x0E[3]	0x0E[2]
Default Value		0	0	0	0	0	0	0	0
Description	0x08	Reserved	Reserved	Reserved	Reserved	Reserved	Reserved	CH0_EQ_1	CH0_EQ_0
SMBus Register		0x0F[7]	0x0F[6]	0x0F[5]	0x0F[4]	0x0F[3]	0x0F[2]	0x0F[1]	0x0F[0]
Default Value		0	0	1	0	1	1	1	1

Table 6. EEPROM Address Map - Single Device With Default Value (continued)

EEPROM Address Byte		Bit 7	Bit 6	Bit 5	Bit 4	Bit 3	Bit 2	Bit 1	Bit 0
Description	0x09	CH0_SCP	Reserved	Reserved	Reserved	Reserved	CH0_VOD_2	CH0_VOD_1	CH0_VOD_0
SMBus Register		0x10[7]	0x10[6]	0x10[5]	0x10[4]	0x10[3]	0x10[2]	0x10[1]	0x10[0]
Default Value		0xAD	1	0	1	0	1	1	0
Description	0x0A	CH0_VOD_DB_2	CH0_VOD_DB_1	CH0_VOD_DB_0	Reserved	CH0_THa_1	CH0_THa_0	CH0_THd_1	CH0_THd_0
SMBus Register		0x11[2]	0x11[1]	0x11[0]	0x12[7]	0x12[3]	0x12[2]	0x12[1]	0x12[0]
Default Value		0x40	0	1	0	0	0	0	0
Description	0x0B	Reserved	Reserved	CH1_RXDET_1	CH1_RXDET_0	Reserved	Reserved	Reserved	Reserved
SMBus Register		0x15[5]	0x15[4]	0x15[3]	0x15[2]	0x16[7]	0x16[6]	0x16[5]	0x16[4]
Default Value		0x02	0	0	0	0	0	1	0
Description	0x0C	Reserved	Reserved	CH1_EQ_1	CH1_EQ_0	CH1_SCP	Reserved	Reserved	Reserved
SMBus Register		0x16[3]	0x16[2]	0x16[1]	0x16[0]	0x17[7]	0x17[6]	0x17[5]	0x17[4]
Default Value		0xFA	1	1	1	1	1	0	1
Description	0x0D	Reserved	CH1_VOD_2	CH1_VOD_1	CH1_VOD_0	CH1_VOD_DB_2	CH1_VOD_DB_1	CH1_VOD_DB_0	Reserved
SMBus Register		0x17[3]	0x17[2]	0x17[1]	0x17[0]	0x18[2]	0x18[1]	0x18[0]	0x19[7]
Default Value		0xD4	1	1	0	1	0	1	0
Description	0x0E	CH1_THa_1	CH1_THa_0	CH1_THd_1	CH1_THd_0	Reserved	Reserved	CH2_RXDET_1	CH2_RXDET_0
SMBus Register		0x19[3]	0x19[2]	0x19[1]	0x19[0]	0x1C[5]	0x1C[4]	0x1C[3]	0x1C[2]
Default Value		0x00	0	0	0	0	0	0	0
Description	0x0F	Reserved	Reserved	Reserved	Reserved	Reserved	Reserved	CH2_EQ_1	CH2_EQ_0
SMBus Register		0x1D[7]	0x1D[6]	0x1D[5]	0x1D[4]	0x1D[3]	0x1D[2]	0x1D[1]	0x1D[0]
Default Value		0x2F	0	0	1	0	1	1	1
Description	0x10	CH2_SCP	Reserved	Reserved	Reserved	Reserved	CH2_VOD_2	CH2_VOD_1	CH2_VOD_0
SMBus Register		0x1E[7]	0x1E[6]	0x1E[5]	0x1E[4]	0x1E[3]	0x1E[2]	0x1E[1]	0x1E[0]
Default Value		0xAD	1	0	1	0	1	1	0

Table 6. EEPROM Address Map - Single Device With Default Value (continued)

EEPROM Address Byte		Bit 7	Bit 6	Bit 5	Bit 4	Bit 3	Bit 2	Bit 1	Bit 0
Description	0x11	CH2_VOD_DB_2	CH2_VOD_DB_1	CH2_VOD_DB_0	Reserved	CH2_THa_1	CH2_THa_0	CH2_THd_1	CH2_THd_0
SMBus Register		0x1F[2]	0x1F[1]	0x1F[0]	0x20[7]	0x20[3]	0x20[2]	0x20[1]	0x20[0]
Default Value		0	1	0	0	0	0	0	0
Description	0x12	Reserved	Reserved	CH3_RXDET_1	CH3_RXDET_0	Reserved	Reserved	Reserved	Reserved
SMBus Register		0x23[5]	0x23[4]	0x23[3]	0x23[2]	0x24[7]	0x24[6]	0x24[5]	0x24[4]
Default Value		0	0	0	0	0	0	1	0
Description	0x13	Reserved	Reserved	CH3_EQ_1	CH3_EQ_0	CH3_SCP	Reserved	Reserved	Reserved
SMBus Register		0x24[3]	0x24[2]	0x24[1]	0x24[0]	0x25[7]	0x25[6]	0x25[5]	0x25[4]
Default Value		1	1	1	1	1	0	1	0
Description	0x14	Reserved	CH3_VOD_2	CH3_VOD_1	CH3_VOD_0	CH3_VOD_DB_2	CH3_VOD_DB_1	CH3_VOD_DB_0	Reserved
SMBus Register		0x25[3]	0x25[2]	0x25[1]	0x25[0]	0x26[2]	0x26[1]	0x26[0]	0x27[7]
Default Value		1	1	0	1	0	1	0	0
Description	0x15	CH3_THa_1	CH3_THa_0	CH3_THd_1	CH3_THd_0	Reserved	hi_idle_SD CH0-3	hi_idle_SD CH4-7	fast_SD CH0-3
SMBus Register		0x27[3]	0x27[2]	0x27[1]	0x27[0]	0x28[6]	0x28[5]	0x28[4]	0x28[3]
Default Value		0	0	0	0	1	0	0	1
Description	0x16	fast_SD CH4-7	lo_gain_SD CH0-3	lo_gain_SD CH4-7	Reserved	Reserved	CH4_RXDET_1	CH4_RXDET_0	Reserved
SMBus Register		0x28[2]	0x28[1]	0x28[0]	0x2B[5]	0x2B[4]	0x2B[3]	0x2B[2]	0x2C[7]
Default Value		1	0	0	0	0	0	0	0
Description	0x17	Reserved	Reserved	Reserved	Reserved	Reserved	CH4_EQ_1	CH4_EQ_0	CH4_SCP
SMBus Register		0x2C[6]	0x2C[5]	0x2C[4]	0x2C[3]	0x2C[2]	0x2C[1]	0x2C[0]	0x2D[7]
Default Value		0	1	0	1	1	1	1	1
Description	0x18	Reserved	Reserved	Reserved	Reserved	CH4_VOD_2	CH4_VOD_1	CH4_VOD_0	CH4_VOD_DB_2
SMBus Register		0x2D[6]	0x2D[5]	0x2D[4]	0x2D[3]	0x2D[2]	0x2D[1]	0x2D[0]	0x2E[2]
Default Value		0	1	0	1	1	0	1	0

Table 6. EEPROM Address Map - Single Device With Default Value (continued)

EEPROM Address Byte		Bit 7	Bit 6	Bit 5	Bit 4	Bit 3	Bit 2	Bit 1	Bit 0
Description	0x19	CH4_VOD_DB_1	CH4_VOD_DB_0	Reserved	CH4_THa_1	CH4_THa_0	CH4_THd_1	CH4_THd_0	Reserved
SMBus Register		0x2E[1]	0x2E[0]	0x2F[7]	0x2F[3]	0x2F[2]	0x2F[1]	0x2F[0]	0x32[5]
Default Value		0x80	1	0	0	0	0	0	0
Description	0x1A	Reserved	CH5_RXDET_1	CH5_RXDET_0	Reserved	Reserved	Reserved	Reserved	Reserved
SMBus Register		0x32[4]	0x32[3]	0x32[2]	0x33[7]	0x33[6]	0x33[5]	0x33[4]	0x33[3]
Default Value		0x05	0	0	0	0	0	1	0
Description	0x1B	Reserved	CH5_EQ_1	CH5_EQ_0	CH5_SCP	Reserved	Reserved	Reserved	Reserved
SMBus Register		0x33[2]	0x33[1]	0x33[0]	0x34[7]	0x34[6]	0x34[5]	0x34[4]	0x34[3]
Default Value		0xF5	1	1	1	1	0	1	0
Description	0x1C	CH5_VOD_2	CH5_VOD_1	CH5_VOD_0	CH5_VOD_DB_2	CH5_VOD_DB_1	CH5_VOD_DB_0	Reserved	CH5_THa_1
SMBus Register		0x34[2]	0x34[1]	0x34[0]	0x35[2]	0x35[1]	0x35[0]	0x36[7]	0x36[3]
Default Value		0xA8	1	0	1	0	1	0	0
Description	0x1D	CH5_THa_0	CH5_THd_1	CH5_THd_0	Reserved	Reserved	CH6_RXDET_1	CH6_RXDET_0	Reserved
SMBus Register		0x36[2]	0x36[1]	0x36[0]	0x39[5]	0x39[4]	0x39[3]	0x39[2]	0x3A[7]
Default Value		0x00	0	0	0	0	0	0	0
Description	0x1E	Reserved	Reserved	Reserved	Reserved	Reserved	CH6_EQ_1	CH6_EQ_0	CH6_SCP
SMBus Register		0x3A[6]	0x3A[5]	0x3A[4]	0x3A[3]	0x3A[2]	0x3A[1]	0x3A[0]	0x3B[7]
Default Value		0x5F	0	1	0	1	1	1	1
Description	0x1F	Reserved	Reserved	Reserved	Reserved	CH6_VOD_2	CH6_VOD_1	CH6_VOD_0	CH6_VOD_DB_2
SMBus Register		0x3B[6]	0x3B[5]	0x3B[4]	0x3B[3]	0x3B[2]	0x3B[1]	0x3B[0]	0x3C[2]
Default Value		0x5A	0	1	0	1	1	0	1
Description	0x20	CH6_VOD_DB_1	CH6_VOD_DB_0	Reserved	CH6_THa_1	CH6_THa_0	CH6_THd_1	CH6_THd_0	Reserved
SMBus Register		0x3C[1]	0x3C[0]	0x3D[7]	0x3D[3]	0x3D[2]	0x3D[1]	0x3D[0]	0x40[5]
Default Value		0x80	1	0	0	0	0	0	0

Table 6. EEPROM Address Map - Single Device With Default Value (continued)

EEPROM Address Byte		Bit 7	Bit 6	Bit 5	Bit 4	Bit 3	Bit 2	Bit 1	Bit 0
Description	0x21	Reserved	CH7_RXDET_1	CH7_RXDET_0	Reserved	Reserved	Reserved	Reserved	Reserved
SMBus Register		0x40[4]	0x40[3]	0x40[2]	0x41[7]	0x41[6]	0x41[5]	0x41[4]	0x41[3]
Default Value		0	0	0	0	0	1	0	1
<hr/>									
Description	0x22	Reserved	CH7_EQ_1	CH7_EQ_0	CH7_SCP	Reserved	Reserved	Reserved	Reserved
SMBus Register		0x41[2]	0x41[1]	0x41[0]	0x42[7]	0x42[6]	0x42[5]	0x42[4]	0x42[3]
Default Value		1	1	1	1	0	1	0	1
<hr/>									
Description	0x23	CH7_VOD_2	CH7_VOD_1	CH7_VOD_0	CH7_VOD_DB_2	CH7_VOD_DB_1	CH7_VOD_DB_0	Reserved	CH7_THa_1
SMBus Register		0x42[2]	0x42[1]	0x42[0]	0x43[2]	0x43[1]	0x43[0]	0x44[7]	0x44[3]
Default Value		1	0	1	0	1	0	0	0
<hr/>									
Description	0x24	CH7_THa_0	CH7_THd_1	CH7_THd_0	Reserved	Reserved	Reserved	Reserved	Reserved
SMBus Register		0x44[2]	0x44[1]	0x44[0]	0x47[3]	0x47[2]	0x47[1]	0x47[0]	0x48[7]
Default Value		0	0	0	0	0	0	0	0
<hr/>									
Description	0x25	Reserved	Reserved	Reserved	Reserved	Reserved	Reserved	Reserved	Reserved
SMBus Register		0x48[6]	0x4C[7]	0x4C[6]	0x4C[5]	0x4C[4]	0x4C[3]	0x4C[0]	0x59[0]
Default Value		0	0	0	0	0	0	0	0
<hr/>									
Description	0x26	Reserved	Reserved	Reserved	Reserved	Reserved	Reserved	Reserved	Reserved
SMBus Register		0x5A[7]	0x5A[6]	0x5A[5]	0x5A[4]	0x5A[3]	0x5A[2]	0x5A[1]	0x5A[0]
Default Value		0	1	0	1	0	1	0	0
<hr/>									
Description	0x27	Reserved	Reserved	Reserved	Reserved	Reserved	Reserved	Reserved	Reserved
SMBus Register		0x5B[7]	0x5B[6]	0x5B[5]	0x5B[4]	0x5B[3]	0x5B[2]	0x5B[1]	0x5B[0]
Default Value		0	1	0	1	0	1	0	0

Table 7. Example Of EEPROM For Four Devices Using Two Address Maps

EEPROM Address	Address (Hex)	EEPROM Data	Comments
0	00	0x43	CRC_EN = 0, Address Map = 1, >256 bytes = 0, Device Count[3:0] = 3
1	01	0x00	
2	02	0x10	EEPROM Burst Size
3	03	0x00	CRC not used
4	04	0x0B	Device 0 Address Location
5	05	0x00	CRC not used
6	06	0x0B	Device 1 Address Location
7	07	0x00	CRC not used
8	08	0x30	Device 2 Address Location
9	09	0x00	CRC not used
10	0A	0x30	Device 3 Address Location
11	0B	0x00	Begin Device 0, 1 - Address Offset 3
12	0C	0x00	
13	0D	0x04	
14	0E	0x07	
15	0F	0x00	
16	10	0x01	EQ CHB0 = 0x01
17	11	0xAD	VOD CHB0 = 101'b
18	12	0x00	VOD_DB CHB0 = 000'b
19	13	0x00	
20	14	0x1A	EQ CHB1 = 0x01
21	15	0xD0	VOD CHB1 = 101'b, VOD_DB CHB1 = 000'b
22	16	0x00	
23	17	0x01	EQ CHB2 = 0x01
24	18	0xAD	VOD CHB2 = 101'b
25	19	0x00	VOD_DB CHB2 = 000'b
26	1A	0x00	
27	1B	0x1A	EQ CHB3 = 0x01
28	1C	0xD0	VOD CHB3 = 101'b, VOD_DB CHB3 = 000'b
29	1D	0x09	Signal Detect Status Threshold Control
30	1E	0x80	Signal Detect Status Threshold Control
31	1F	0x07	EQ CHA0 = 0x03
32	20	0x5C	VOD CHA0 = 110'b
33	21	0x00	VOD_DB CHA0 = 000'b
34	22	0x00	
35	23	0x15	EQ CHA1 = 0x00
36	24	0xC0	VOD CHA1 = 110'b, VOD_DB CHA1 = 000'b
37	25	0x00	
38	26	0x07	EQ CHA2 = 0x03
39	27	0x5C	VOD CHA2 = 110'b
40	28	0x00	VOD_DB CHA2 = 000'b
41	29	0x00	
42	2A	0x75	EQ CHA3 = 0x00
43	2B	0xC0	VOD CHA3 = 110'b, VOD_DB CHA3 = 000'b
44	2C	0x00	
45	2D	0x00	
46	2E	0x54	

Table 7. Example Of EEPROM For Four Devices Using Two Address Maps (continued)

EEPROM Address	Address (Hex)	EEPROM Data	Comments
47	2F	0x54	End Device 0, 1 - Address Offset 39
48	30	0x00	Begin Device 2, 3 - Address Offset 3
49	31	0x00	
50	32	0x04	
51	33	0x07	
52	34	0x00	
53	35	0x01	EQ CHB0 = 0x01
54	36	0xAB	VOD CHB0 = 011'b
55	37	0x00	VOD_DB CHB0 = 000'b
56	38	0x00	
57	39	0x1A	EQ CHB1 = 0x01
58	3A	0xB0	VOD CHB1 = 011'b, VOD_DB CHB1 = 000'b
59	3B	0x00	
60	3C	0x01	EQ CHB2 = 0x01
61	3D	0xAB	VOD CHB2 = 011'b
62	3E	0x00	VOD_DB CHB2 = 000'b
63	3F	0x00	
64	40	0x1A	EQ CHB3 = 0x01
65	41	0xB0	VOD CHB3 = 011'b, VOD_DB CHB3 = 000'b
66	42	0x09	Signal Detect Status Threshold Control
67	43	0x80	Signal Detect Status Threshold Control
68	44	0x07	EQ CHA0 = 0x03
69	45	0x5C	VOD CHA0 = 110'b
70	46	0x00	VOD_DB CHA0 = 000'b
71	47	0x00	
72	48	0x15	EQ CHA1 = 0x00
73	49	0xA0	VOD CHA1 = 101'b, VOD_DB CHA1 = 000'b
74	4A	0x00	
75	4B	0x07	EQ CHA2 = 0x03
76	4C	0x5C	VOD CHA2 = 110'b
77	4D	0x00	VOD_DB CHA2 = 000'b
78	4E	0x00	
79	4F	0x15	EQ CHA3 = 0x00
80	50	0xA0	VOD CHA3 = 101'b, VOD_DB CHA3 = 000'b
81	51	0x00	
82	52	0x00	
83	53	0x54	
84	54	0x54	End Device 2, 3 - Address Offset 39

Note: CRC_EN = 0, Address Map = 1, >256 byte = 0, Device Count[3:0] = 3. Multiple devices can point to the same address map. Maximum EEPROM size is 8 kbits (1024 x 8-bits).

7.5.2 SMBus

The System Management Bus interface is compatible to SMBus 2.0 physical layer specification. Tie ENSMB = 1 kΩ to VDD (2.5 V mode) or VIN (3.3 V mode) to enable SMBus Slave Mode and allow access to the configuration registers.

The DS80PCI810 uses AD[3:0] inputs in both SMBus Modes. These AD[3:0] pins are the user set SMBus slave address inputs and have internal pull-downs. Based on the SMBus 2.0 specification, the DS80PCI810 has a 7-bit slave address. The LSB is set to 0'b (for a WRITE). When AD[3:0] pins are left floating or pulled low, AD[3:0] = 0000'b, and the device default address byte is 0xB0. The device supports up to 16 address bytes, as shown in [Table 8](#):

Table 8. Device Slave Address Bytes

AD[3:0] Settings	Full Slave Address Byte (7-Bit Address + Write Bit)	7-Bit Slave Address (Hex)
0000	B0	58
0001	B2	59
0010	B4	5A
0011	B6	5B
0100	B8	5C
0101	BA	5D
0110	BC	5E
0111	BE	5F
1000	C0	60
1001	C2	61
1010	C4	62
1011	C6	63
1100	C8	64
1101	CA	65
1110	CC	66
1111	CE	67

The SDA/SCL pins are 3.3 V tolerant, but are not 5 V tolerant. An external pull-up resistor is required on the SDA and SCL line. The resistor value can be from 2 kΩ to 5 kΩ depending on the voltage, loading, and speed.

7.5.3 Transfer Of Data Via The SMBus

During normal operation, the data on SDA must be stable during the time when SCL is High.

There are three unique states for the SMBus:

START: A High-to-Low transition on SDA while SCL is High indicates a message START condition.

STOP: A Low-to-High transition on SDA while SCL is High indicates a message STOP condition.

IDLE: If SCL and SDA are both High for a time exceeding t_{BUF} from the last detected STOP condition or if they are High for a total exceeding the maximum specification for t_{HIGH} , then the bus transfers to the IDLE state.

7.5.4 SMBus Transactions

The device supports WRITE and READ transactions. See [Table 9](#) for register address, type (Read/Write, Read Only), default value, and function information.

7.6 Writing a Register

To write a register, the following protocol is used (see SMBus 2.0 specification).

1. The Host drives a START condition, the 7-bit SMBus address, and a "0" indicating a WRITE.
2. The Device (Slave) drives the ACK bit ("0").
3. The Host drives the 8-bit Register Address.
4. The Device drives an ACK bit ("0").
5. The Host drive the 8-bit data byte.
6. The Device drives an ACK bit ("0").
7. The Host drives a STOP condition.

Writing a Register (continued)

The WRITE transaction is completed, the bus goes IDLE, and communication with other SMBus devices may now occur.

7.7 Reading a Register

To read a register, the following protocol is used (see SMBus 2.0 specification).

1. The Host drives a START condition, the 7-bit SMBus address, and a “0” indicating a WRITE.
2. The Device (Slave) drives the ACK bit (“0”).
3. The Host drives the 8-bit Register Address.
4. The Device drives an ACK bit (“0”).
5. The Host drives a START condition.
6. The Host drives the 7-bit SMBus Address, and a “1” indicating a READ.
7. The Device drives an ACK bit “0”.
8. The Device drives the 8-bit data value (register contents).
9. The Host drives a NACK bit “1” indicating end of the READ transfer.
10. The Host drives a STOP condition.

The READ transaction is completed, the bus goes IDLE, and communication with other SMBus devices may now occur.

7.8 Register Maps

Table 9. SMBus Slave Mode Register Map

Address	Register Name	Bit	Field	Type	Default	EEPROM Reg Bit	Description	
0x00	Observation	7	Reserved	R/W	0x00		Set bit to 0	
		6:3	Address Bit AD[3:0]	R			Observation of AD[3:0] bits [6]: AD3 [5]: AD2 [4]: AD1 [3]: AD0	
		2	EEPROM Read Done	R			1 = Device completed the read from external EEPROM	
		1	Reserved	R/W			Set bit to 0	
		0	Reserved	R/W			Set bit to 0	
0x01	PWDN Channels	7:0	PWDN CHx	R/W	0x00	Yes	Power Down per Channel [7]: CH7 – CHA_3 [6]: CH6 – CHA_2 [5]: CH5 – CHA_1 [4]: CH4 – CHA_0 [3]: CH3 – CHB_3 [2]: CH2 – CHB_2 [1]: CH1 – CHB_1 [0]: CH0 – CHB_0 0x00 = all channels enabled 0xFF = all channels disabled Note: Override PWDN pin and enable register control via Reg 0x02[0]	
0x02	Override PWDN, PRSNT	7	Override PRSNT	R/W	0x00		1 = Override Automatic Rx Detect State Machine Reset	
		6	PRSNT Value				1 = Set Rx Detect State Machine Reset 0 = Clear Rx Detect State Machine Reset	
		5:2	Reserved				Yes	Set bits to 0
		1	Reserved					Set bit to 0
		0	Override PWDN				Yes	1 = Block PWDN pin control (Register control enabled) 0 = Allow PWDN pin control (Register control disabled)
0x03	Reserved	7:0	Reserved	R/W	0x00		Set bits to 0	
0x04	Reserved	7:0	Reserved	R/W	0x00	Yes	Set bits to 0	
0x05	Reserved	7:0	Reserved	R/W	0x00		Set bits to 0	
0x06	Slave Register Control	7:5	Reserved	R/W	0x10		Set bits to 0	
		4	Reserved				Yes	Set bit to 1
		3	Register Enable				1 = Enable SMBus Slave Mode Register Control Note: In order to change VOD, VOD_DB, and EQ of the channels in slave mode, this bit must be set to 1.	
		2:0	Reserved				Set bits to 0	
0x07	Digital Reset and Control	7	Reserved	R/W	0x01		Set bit to 0	
		6	Reset Registers				1 = Self clearing reset for SMBus registers (register settings return to default values)	
		5	Reset SMBus Master				1 = Self clearing reset to SMBus master state machine	
		4:0	Reserved				Set bits to 0 0001'b	

Register Maps (continued)
Table 9. SMBus Slave Mode Register Map (continued)

Address	Register Name	Bit	Field	Type	Default	EEPROM Reg Bit	Description
0x08	Override Pin Control	7	Reserved	R/W	0x00		Set bit to 0
		6	Override SD_TH			Yes	1 = Block SD_TH pin control (Register control enabled) 0 = Allow SD_TH pin control (Register control disabled)
		5:4	Reserved			Yes	Set bits to 0
		3	Override RXDET			Yes	1 = Block RXDET pin control (Register control enabled) 0 = Allow RXDET pin control (Register control disabled)
		2:0	Reserved			Yes	Set bits to 0
0x09	Reserved	7:0	Reserved	R/W	0x00		Set bits to 0
0x0A	Signal Detect Monitor	7:0	SD_TH Status	R	0x00		CH7 - CH0 Internal Signal Detect Indicator [7]: CH7 – CHA_3 [6]: CH6 – CHA_2 [5]: CH5 – CHA_1 [4]: CH4 – CHA_0 [3]: CH3 – CHB_3 [2]: CH2 – CHB_2 [1]: CH1 – CHB_1 [0]: CH0 – CHB_0 0 = Signal detected at input 1 = Signal not detected at input Note: These bits only function when RESERVED2 pin = FLOAT
0x0B	Reserved	7	Reserved	R/W	0x00		Set bit to 0
		6:0	Reserved	R/W	0x70	Yes	Set bits to 111 0000'b
0x0C-0x0D	Reserved	7:0	Reserved	R/W	0x00		Set bits to 0
0x0E	CH0 - CHB_0 RXDET	7:6	Reserved	R/W	0x00		Set bits to 0
		5:4	Reserved			Yes	Set bits to 0
		3:2	RXDET			Yes	00'b = Input is Hi-Z impedance 01'b = Auto Rx-Detect, outputs test every 12 ms for 600 ms (50 times) then stops; termination is Hi-Z until detection; once detected input termination is 50 Ω 10'b = Auto Rx-Detect, outputs test every 12 ms until detection occurs; termination is Hi-Z until detection; once detected input termination is 50 Ω 11'b = Input is 50 Ω Note: Override RXDET pin and enable register control via Reg 0x08[3]
		1:0	Reserved				Set bits to 0
0x0F	CH0 - CHB_0 EQ	7:0	EQ Control	R/W	0x2F	Yes	INB_0 EQ Control - total of four levels. See Table 4 .
0x10	CH0 - CHB_0 VOD	7	Short Circuit Protection	R/W	0xAD	Yes	1 = Enable the short circuit protection 0 = Disable the short circuit protection
		6:3	Reserved			Yes	Set bits to 0101'b
		2:0	VOD Control			Yes	OUTB_0 VOD Control: VOD / VID Ratio 000'b = 0.57 001'b = 0.65 010'b = 0.71 011'b = 0.77 100'b = 0.83 101'b = 0.90 (default) 110'b = 1.00 (recommended) 111'b = 1.04

Register Maps (continued)
Table 9. SMBus Slave Mode Register Map (continued)

Address	Register Name	Bit	Field	Type	Default	EEPROM Reg Bit	Description
0x11	CH0 - CHB_0 VOD_DB	7	RXDET Status	R	0x02		Observation bit for RXDET CH0 - CHB_0 1 = Input 50 Ω terminated to VDD 0 = Input is Hi-Z
		6:5	Reserved				Set bits to 0
		4:3	Reserved				Set bits to 0
		2:0	VOD_DB Control	R/W		Yes	OUTB_0 VOD_DB Control 000'b = 0 dB (recommended) 001'b = -1.5 dB 010'b = -3.5 dB (default) 011'b = -5 dB 100'b = -6 dB 101'b = -8 dB 110'b = -9 dB 111'b = -12 dB Note: Changing VOD_DB bits effectively lowers the output VOD dynamic range by a factor of the corresponding amount of dB reduction.
0x12	CH0 - CHB_0 SD_TH	7	Reserved	R/W	0x00	Yes	Set bit to 0
		6:4	Reserved				Set bits to 0
		3:2	Signal Detect Status Assert Threshold			Yes	Status Assert threshold (1010 pattern 12 Gbps) 00'b = 50 mVp-p (default) 01'b = 40 mVp-p 10'b = 75 mVp-p 11'b = 58 mVp-p Note: Override SD_TH pin and enable register control via Reg 0x08[6]
		1:0	Signal Detect Status De-assert Threshold			Yes	Status De-assert threshold (1010 pattern 12 Gbps) 00'b = 37 mVp-p (default) 01'b = 22 mVp-p 10'b = 55 mVp-p 11'b = 45 mVp-p Note: Override SD_TH pin and enable register control via Reg 0x08[6]
0x13-0x14	Reserved	7:0	Reserved	R/W	0x00		Set bits to 0
0x15	CH1 - CHB_1 RXDET	7:6	Reserved	R/W	0x00		Set bits to 0
		5:4	Reserved			Yes	Set bits to 0
		3:2	RXDET			Yes	00'b = Input is Hi-Z impedance 01'b = Auto Rx-Detect, outputs test every 12 ms for 600 ms (50 times) then stops; termination is Hi-Z until detection; once detected input termination is 50 Ω 10'b = Auto Rx-Detect, outputs test every 12 ms until detection occurs; termination is Hi-Z until detection; once detected input termination is 50 Ω 11'b = Input is 50 Ω Note: Override RXDET pin and enable register control via Reg 0x08[3]
		1:0	Reserved				Set bits to 0
0x16	CH1 - CHB_1 EQ	7:0	EQ Control	R/W	0x2F	Yes	INB_1 EQ Control - total of four levels. See Table 4 .

Register Maps (continued)
Table 9. SMBus Slave Mode Register Map (continued)

Address	Register Name	Bit	Field	Type	Default	EEPROM Reg Bit	Description
0x17	CH1 - CHB_1 VOD	7	Short Circuit Protection	R/W	0xAD	Yes	1 = Enable the short circuit protection 0 = Disable the short circuit protection
		6:3	Reserved			Yes	Set bits to 0101'b
		2:0	VOD Control			Yes	OUTB_1 VOD Control: VOD / VID Ratio 000'b = 0.57 001'b = 0.65 010'b = 0.71 011'b = 0.77 100'b = 0.83 101'b = 0.90 (default) 110'b = 1.00 (recommended) 111'b = 1.04
0x18	CH1 - CHB_1 VOD_DB	7	RXDET Status	R	0x02		Observation bit for RXDET CH1 - CHB_1 1 = Input 50 Ω terminated to VDD 0 = Input is Hi-Z
		6:5	Reserved			Set bits to 0	
		4:3	Reserved			Set bits to 0	
		2:0	VOD_DB Control	R/W		Yes	OUTB_1 VOD_DB Control 000'b = 0 dB (recommended) 001'b = -1.5 dB 010'b = -3.5 dB (default) 011'b = -5 dB 100'b = -6 dB 101'b = -8 dB 110'b = -9 dB 111'b = -12 dB Note: Changing VOD_DB bits effectively lowers the output VOD dynamic range by a factor of the corresponding amount of dB reduction.
0x19	CH1 - CHB_1 SD_TH	7	Reserved	R/W	0x00	Yes	Set bit to 0
		6:4	Reserved				Set bits to 0
		3:2	Signal Detect Status Assert Threshold			Yes	Status Assert threshold (1010 pattern 12 Gbps) 00'b = 50 mVp-p (default) 01'b = 40 mVp-p 10'b = 75 mVp-p 11'b = 58 mVp-p Note: Override SD_TH pin and enable register control via Reg 0x08[6]
		1:0	Signal Detect Status De-assert Threshold			Yes	Status De-assert threshold (1010 pattern 12 Gbps) 00'b = 37 mVp-p (default) 01'b = 22 mVp-p 10'b = 55 mVp-p 11'b = 45 mVp-p Note: Override SD_TH pin and enable register control via Reg 0x08[6]
0x1A-0x1B	Reserved	7:0	Reserved	R/W	0x00		Set bits to 0

Register Maps (continued)
Table 9. SMBus Slave Mode Register Map (continued)

Address	Register Name	Bit	Field	Type	Default	EEPROM Reg Bit	Description
0x1C	CH2 - CHB_2 RXDET	7:6	Reserved	R/W	0x00		Set bits to 0
		5:4	Reserved			Yes	Set bits to 0
		3:2	RXDET			Yes	00'b = Input is Hi-Z impedance 01'b = Auto Rx-Detect, outputs test every 12 ms for 600 ms (50 times) then stops; termination is Hi-Z until detection; once detected input termination is 50 Ω 10'b = Auto Rx-Detect, outputs test every 12 ms until detection occurs; termination is Hi-Z until detection; once detected input termination is 50 Ω 11'b = Input is 50 Ω Note: Override RXDET pin and enable register control via Reg 0x08[3]
		1:0	Reserved				Set bits to 0
0x1D	CH2 - CHB_2 EQ	7:0	EQ Control	R/W	0x2F	Yes	INB_2 EQ Control - total of four levels. See Table 4 .
0x1E	CH2 - CHB_2 VOD	7	Short Circuit Protection	R/W	0xAD	Yes	1 = Enable the short circuit protection 0 = Disable the short circuit protection
		6:3	Reserved			Yes	Set bits to 0101'b
		2:0	VOD Control			Yes	OUTB_2 VOD Control: VOD / VID Ratio 000'b = 0.57 001'b = 0.65 010'b = 0.71 011'b = 0.77 100'b = 0.83 101'b = 0.90 (default) 110'b = 1.00 (recommended) 111'b = 1.04
0x1F	CH2 - CHB_2 VOD_DB	7	RXDET Status	R	0x02		Observation bit for RXDET CH2 - CHB_2 1 = Input 50 Ω terminated to VDD 0 = Input is Hi-Z
		6:5	Reserved			Set bits to 0	
		4:3	Reserved			Set bits to 0	
		2:0	VOD_DB Control	R/W		Yes	OUTB_2 VOD_DB Control 000'b = 0 dB (recommended) 001'b = -1.5 dB 010'b = -3.5 dB (default) 011'b = -5 dB 100'b = -6 dB 101'b = -8 dB 110'b = -9 dB 111'b = -12 dB Note: Changing VOD_DB bits effectively lowers the output VOD dynamic range by a factor of the corresponding amount of dB reduction.

Register Maps (continued)
Table 9. SMBus Slave Mode Register Map (continued)

Address	Register Name	Bit	Field	Type	Default	EEPROM Reg Bit	Description
0x20	CH2 - CHB_2 SD_TH	7	Reserved	R/W	0x00	Yes	Set bit to 0
		6:4	Reserved				Set bits to 0
		3:2	Signal Detect Status Assert Threshold			Yes	Status Assert threshold (1010 pattern 12 Gbps) 00'b = 50 mVp-p (default) 01'b = 40 mVp-p 10'b = 75 mVp-p 11'b = 58 mVp-p Note: Override SD_TH pin and enable register control via Reg 0x08[6]
		1:0	Signal Detect Status De-assert Threshold			Yes	Status De-assert threshold (1010 pattern 12 Gbps) 00'b = 37 mVp-p (default) 01'b = 22 mVp-p 10'b = 55 mVp-p 11'b = 45 mVp-p Note: Override SD_TH pin and enable register control via Reg 0x08[6]
0x21- 0x22	Reserved	7:0	Reserved	R/W	0x00		Set bits to 0
0x23	CH3 - CHB_3 RXDET	7:6	Reserved	R/W	0x00		Set bits to 0
		5:4	Reserved			Yes	Set bits to 0
		3:2	RXDET			Yes	00'b = Input is Hi-Z impedance 01'b = Auto Rx-Detect, outputs test every 12 ms for 600 ms (50 times) then stops; termination is Hi-Z until detection; once detected input termination is 50 Ω 10'b = Auto Rx-Detect, outputs test every 12 ms until detection occurs; termination is Hi-Z until detection; once detected input termination is 50 Ω 11'b = Input is 50 Ω Note: Override RXDET pin and enable register control via Reg 0x08[3]
		1:0	Reserved				Set bits to 0
0x24	CH3 - CHB_3 EQ	7:0	EQ Control	R/W	0x2F	Yes	INB_3 EQ Control - total of four levels. See Table 4 .
0x25	CH3 - CHB_3 VOD	7	Short Circuit Protection	R/W	0xAD	Yes	1 = Enable the short circuit protection 0 = Disable the short circuit protection
		6:3	Reserved			Yes	Set bits to 0101'b
		2:0	VOD Control			Yes	OUTB_3 VOD Control: VOD / VID Ratio 000'b = 0.57 001'b = 0.65 010'b = 0.71 011'b = 0.77 100'b = 0.83 101'b = 0.90 (default) 110'b = 1.00 (recommended) 111'b = 1.04

Register Maps (continued)
Table 9. SMBus Slave Mode Register Map (continued)

Address	Register Name	Bit	Field	Type	Default	EEPROM Reg Bit	Description
0x26	CH3 - CHB_3 VOD_DB	7	RXDET Status	R	0x02		Observation bit for RXDET CH3 - CHB_3 1 = Input 50 Ω terminated to VDD 0 = Input is Hi-Z
		6:5	Reserved			Set bits to 0	
		4:3	Reserved			Set bits to 0	
		2:0	VOD_DB Control	R/W		Yes	OUTB_3 VOD_DB Control 000'b = 0 dB (recommended) 001'b = -1.5 dB 010'b = -3.5 dB (default) 011'b = -5 dB 100'b = -6 dB 101'b = -8 dB 110'b = -9 dB 111'b = -12 dB Note: Changing VOD_DB bits effectively lowers the output VOD dynamic range by a factor of the corresponding amount of dB reduction.
0x27	CH3 - CHB_3 SD_TH	7	Reserved	R/W	0x00	Yes	Set bit to 0
		6:4	Reserved				Set bits to 0
		3:2	Signal Detect Status Assert Threshold			Yes	Status Assert threshold (1010 pattern 12 Gbps) 00'b = 50 mVp-p (default) 01'b = 40 mVp-p 10'b = 75 mVp-p 11'b = 58 mVp-p Note: Override SD_TH pin and enable register control via Reg 0x08[6]
		1:0	Signal Detect Status De-assert Threshold			Yes	Status De-assert threshold (1010 pattern 12 Gbps) 00'b = 37 mVp-p (default) 01'b = 22 mVp-p 10'b = 55 mVp-p 11'b = 45 mVp-p Note: Override SD_TH pin and enable register control via Reg 0x08[6]
0x28	Signal Detect Status Control	7	Reserved	R/W	0x4C		Set bit to 0
		6	Reserved			Yes	Set bit to 1
		5:4	High SD_TH Status			Yes	Enable Higher Range of Signal Detect Status Thresholds [5]: CH0 - CH3 [4]: CH4 - CH7
		3:2	Fast Signal Detect Status			Yes	Enable Fast Signal Detect Status [3]: CH0 - CH3 [2]: CH4 - CH7 Note: In Fast Signal Detect, assert/de-assert response occurs after approximately 3-4 ns
		1:0	Reduced SD Status Gain			Yes	Enable Reduced Signal Detect Status Gain [1]: CH0 - CH3 [0]: CH4 - CH7
0x29-0x2A	Reserved	7:0	Reserved	R/W	0x00		Set bits to 0

Register Maps (continued)
Table 9. SMBus Slave Mode Register Map (continued)

Address	Register Name	Bit	Field	Type	Default	EEPROM Reg Bit	Description
0x2B	CH4 - CHA_0 RXDET	7:6	Reserved	R/W	0x00		Set bits to 0
		5:4	Reserved			Yes	Set bits to 0
		3:2	RXDET			Yes	00'b = Input is Hi-Z impedance 01'b = Auto Rx-Detect, outputs test every 12 ms for 600 ms (50 times) then stops; termination is Hi-Z until detection; once detected input termination is 50 Ω 10'b = Auto Rx-Detect, outputs test every 12 ms until detection occurs; termination is Hi-Z until detection; once detected input termination is 50 Ω 11'b = Input is 50 Ω Note: Override RXDET pin and enable register control via Reg 0x08[3]
		1:0	Reserved				Set bits to 0
0x2C	CH4 - CHA_0 EQ	7:0	EQ Control	R/W	0x2F	Yes	INA_0 EQ Control - total of four levels. See Table 4.
0x2D	CH4 - CHA_0 VOD	7	Short Circuit Protection	R/W	0xAD	Yes	1 = Enable the short circuit protection 0 = Disable the short circuit protection
		6:3	Reserved			Yes	Set bits to 0101'b
		2:0	VOD Control			Yes	OUTA_0 VOD Control: VOD / VID Ratio 000'b = 0.57 001'b = 0.65 010'b = 0.71 011'b = 0.77 100'b = 0.83 101'b = 0.90 (default) 110'b = 1.00 (recommended) 111'b = 1.04
0x2E	CH4 - CHA_0 VOD_DB	7	RXDET Status	R	0x02		Observation bit for RXDET CH4 - CHA_0 1 = Input 50 Ω terminated to VDD 0 = Input is Hi-Z
		6:5	Reserved			Set bits to 0	
		4:3	Reserved			Set bits to 0	
		2:0	VOD_DB Control	R/W		Yes	OUTA_0 VOD_DB Control 000'b = 0 dB (recommended) 001'b = -1.5 dB 010'b = -3.5 dB (default) 011'b = -5 dB 100'b = -6 dB 101'b = -8 dB 110'b = -9 dB 111'b = -12 dB Note: Changing VOD_DB bits effectively lowers the output VOD dynamic range by a factor of the corresponding amount of dB reduction.

Register Maps (continued)
Table 9. SMBus Slave Mode Register Map (continued)

Address	Register Name	Bit	Field	Type	Default	EEPROM Reg Bit	Description
0x2F	CH4 - CHA_0 SD_TH	7	Reserved	R/W	0x00	Yes	Set bit to 0
		6:4	Reserved				Set bits to 0
		3:2	Signal Detect Status Assert Threshold			Yes	Status Assert threshold (1010 pattern 12 Gbps) 00'b = 50 mVp-p (default) 01'b = 40 mVp-p 10'b = 75 mVp-p 11'b = 58 mVp-p Note: Override SD_TH pin and enable register control via Reg 0x08[6]
		1:0	Signal Detect Status De-assert Threshold			Yes	Status De-assert threshold (1010 pattern 12 Gbps) 00'b = 37 mVp-p (default) 01'b = 22 mVp-p 10'b = 55 mVp-p 11'b = 45 mVp-p Note: Override SD_TH pin and enable register control via Reg 0x08[6]
0x30- 0x31	Reserved	7:0	Reserved	R/W	0x00		Set bits to 0
0x32	CH5 - CHA_1 RXDET	7:6	Reserved	R/W	0x00		Set bits to 0
		5:4	Reserved			Yes	Set bits to 0
		3:2	RXDET			Yes	00'b = Input is Hi-Z impedance 01'b = Auto Rx-Detect, outputs test every 12 ms for 600 ms (50 times) then stops; termination is Hi-Z until detection; once detected input termination is 50 Ω 10'b = Auto Rx-Detect, outputs test every 12 ms until detection occurs; termination is Hi-Z until detection; once detected input termination is 50 Ω 11'b = Input is 50 Ω Note: Override RXDET pin and enable register control via Reg 0x08[3]
		1:0	Reserved				Set bits to 0
0x33	CH5 - CHA_1 EQ	7:0	EQ Control	R/W	0x2F	Yes	INA_1 EQ Control - total of four levels. See Table 4 .
0x34	CH5 - CHA_1 VOD	7	Short Circuit Protection	R/W	0xAD	Yes	1 = Enable the short circuit protection 0 = Disable the short circuit protection
		6:3	Reserved			Yes	Set bits to 0101'b
		2:0	VOD Control			Yes	OUTA_1 VOD Control: VOD / VID Ratio 000'b = 0.57 001'b = 0.65 010'b = 0.71 011'b = 0.77 100'b = 0.83 101'b = 0.90 (default) 110'b = 1.00 (recommended) 111'b = 1.04

Register Maps (continued)
Table 9. SMBus Slave Mode Register Map (continued)

Address	Register Name	Bit	Field	Type	Default	EEPROM Reg Bit	Description
0x35	CH5 - CHA_1 VOD_DB	7	RXDET Status	R	0x02		Observation bit for RXDET CH5 - CHA1 1 = Input 50 Ω terminated to VDD 0 = Input is Hi-Z
		6:5	Reserved				Set bits to 0
		4:3	Reserved				Set bits to 0
		2:0	VOD_DB Control	R/W		Yes	OUTA_1 VOD_DB Control 000'b = 0 dB (recommended) 001'b = -1.5 dB 010'b = -3.5 dB (default) 011'b = -5 dB 100'b = -6 dB 101'b = -8 dB 110'b = -9 dB 111'b = -12 dB Note: Changing VOD_DB bits effectively lowers the output VOD dynamic range by a factor of the corresponding amount of dB reduction.
0x36	CH5 - CHA_1 SD_TH	7	Reserved	R/W	0x00	Yes	Set bit to 0
		6:4	Reserved				Set bits to 0
		3:2	Signal Detect Status Assert Threshold			Yes	Status Assert threshold (1010 pattern 12 Gbps) 00'b = 50 mVp-p (default) 01'b = 40 mVp-p 10'b = 75 mVp-p 11'b = 58 mVp-p Note: Override SD_TH pin and enable register control via Reg 0x08[6]
		1:0	Signal Detect Status De-assert Threshold			Yes	Status De-assert threshold (1010 pattern 12 Gbps) 00'b = 37 mVp-p (default) 01'b = 22 mVp-p 10'b = 55 mVp-p 11'b = 45 mVp-p Note: Override SD_TH pin and enable register control via Reg 0x08[6]
0x37- 0x38	Reserved	7:0	Reserved	R/W	0x00		Set bits to 0
0x39	CH6 - CHA_2 RXDET	7:6	Reserved	R/W	0x00		Set bits to 0
		5:4	Reserved			Yes	Set bits to 0
		3:2	RXDET			Yes	00'b = Input is Hi-Z impedance 01'b = Auto Rx-Detect, outputs test every 12 ms for 600 ms (50 times) then stops; termination is Hi-Z until detection; once detected input termination is 50 Ω 10'b = Auto Rx-Detect, outputs test every 12 ms until detection occurs; termination is Hi-Z until detection; once detected input termination is 50 Ω 11'b = Input is 50 Ω Note: Override RXDET pin and enable register control via Reg 0x08[3]
		1:0	Reserved				Set bits to 0
0x3A	CH6 - CHA_2 EQ	7:0	EQ Control	R/W	0x2F	Yes	INA_2 EQ Control - total of four levels. See Table 4 .

Register Maps (continued)
Table 9. SMBus Slave Mode Register Map (continued)

Address	Register Name	Bit	Field	Type	Default	EEPROM Reg Bit	Description
0x3B	CH6 - CHA_2 VOD	7	Short Circuit Protection	R/W	0xAD	Yes	1 = Enable the short circuit protection 0 = Disable the short circuit protection
		6:3	Reserved			Yes	Set bits to 0101'b
		2:0	VOD Control			Yes	OUTA_2 VOD Control: VOD / VID Ratio 000'b = 0.57 001'b = 0.65 010'b = 0.71 011'b = 0.77 100'b = 0.83 101'b = 0.90 (default) 110'b = 1.00 (recommended) 111'b = 1.04
0x3C	CH6 - CHA_2 VOD_DB	7	RXDET Status	R	0x02		Observation bit for RXDET CH6 - CHA_2 1 = Input 50 Ω terminated to VDD 0 = Input is Hi-Z
		6:5	Reserved			Set bits to 0	
		4:3	Reserved			Set bits to 0	
		2:0	VOD_DB Control	R/W		Yes	OUTA_2 VOD_DB Control 000'b = 0 dB (recommended) 001'b = -1.5 dB 010'b = -3.5 dB (default) 011'b = -5 dB 100'b = -6 dB 101'b = -8 dB 110'b = -9 dB 111'b = -12 dB Note: Changing VOD_DB bits effectively lowers the output VOD dynamic range by a factor of the corresponding amount of dB reduction.
0x3D	CH6 - CHA_2 SD_TH	7	Reserved	R/W	0x00	Yes	Set bit to 0
		6:4	Reserved				Set bits to 0
		3:2	Signal Detect Status Assert Threshold			Yes	Status Assert threshold (1010 pattern 12 Gbps) 00'b = 50 mVp-p (default) 01'b = 40 mVp-p 10'b = 75 mVp-p 11'b = 58 mVp-p Note: Override SD_TH pin and enable register control via Reg 0x08[6]
		1:0	Signal Detect Status De-assert Threshold			Yes	Status De-assert threshold (1010 pattern 12 Gbps) 00'b = 37 mVp-p (default) 01'b = 22 mVp-p 10'b = 55 mVp-p 11'b = 45 mVp-p Note: Override SD_TH pin and enable register control via Reg 0x08[6]
0x3E-0x3F	Reserved	7:0	Reserved	R/W	0x00		Set bits to 0

Register Maps (continued)
Table 9. SMBus Slave Mode Register Map (continued)

Address	Register Name	Bit	Field	Type	Default	EEPROM Reg Bit	Description
0x40	CH7 - CHA_3 RXDET	7:6	Reserved	R/W	0x00		Set bits to 0
		5:4	Reserved			Yes	Set bits to 0
		3:2	RXDET			Yes	00'b = Input is Hi-Z impedance 01'b = Auto Rx-Detect, outputs test every 12 ms for 600 ms (50 times) then stops; termination is Hi-Z until detection; once detected input termination is 50 Ω 10'b = Auto Rx-Detect, outputs test every 12 ms until detection occurs; termination is Hi-Z until detection; once detected input termination is 50 Ω 11'b = Input is 50 Ω Note: Override RXDET pin and enable register control via Reg 0x08[3]
		1:0	Reserved				Set bits to 0
0x41	CH7 - CHA_3 EQ	7:0	EQ Control	R/W	0x2F	Yes	INA_3 EQ Control - total of four levels. See Table 4 .
0x42	CH7 - CHA_3 VOD	7	Short Circuit Protection	R/W	0xAD	Yes	1 = Enable the short circuit protection 0 = Disable the short circuit protection
		6:3	Reserved			Yes	Set bits to 0101'b
		2:0	VOD Control			Yes	OUTA_3 VOD Control: VOD / VID Ratio 000'b = 0.57 001'b = 0.65 010'b = 0.71 011'b = 0.77 100'b = 0.83 101'b = 0.90 (default) 110'b = 1.00 (recommended) 111'b = 1.04
0x43	CH7 - CHA_3 VOD_DB	7	RXDET Status	R	0x02		Observation bit for RXDET CH7 - CHA_3 1 = Input 50 Ω terminated to VDD 0 = Input is Hi-Z
		6:5	Reserved			Set bits to 0	
		4:3	Reserved			Set bits to 0	
		2:0	VOD_DB Control	R/W		Yes	OUTA_3 VOD_DB Control 000'b = 0 dB (recommended) 001'b = -1.5 dB 010'b = -3.5 dB (default) 011'b = -5 dB 100'b = -6 dB 101'b = -8 dB 110'b = -9 dB 111'b = -12 dB Note: Changing VOD_DB bits effectively lowers the output VOD dynamic range by a factor of the corresponding amount of dB reduction.

Register Maps (continued)
Table 9. SMBus Slave Mode Register Map (continued)

Address	Register Name	Bit	Field	Type	Default	EEPROM Reg Bit	Description
0x44	CH7 - CHA_3 SD_TH	7	Reserved	R/W	0x00	Yes	Set bit to 0
		6:4	Reserved				Set bits to 0
		3:2	Signal Detect Status Assert Threshold			Yes	Status Assert threshold (1010 pattern 12 Gbps) 00'b = 50 mVp-p (default) 01'b = 40 mVp-p 10'b = 75 mVp-p 11'b = 58 mVp-p Note: Override SD_TH pin and enable register control via Reg 0x08[6]
		1:0	Signal Detect Status De-assert Threshold			Yes	Status De-assert threshold (1010 pattern 12 Gbps) 00'b = 37 mVp-p (default) 01'b = 22 mVp-p 10'b = 55 mVp-p 11'b = 45 mVp-p Note: Override SD_TH pin and enable register control via Reg 0x08[6]
0x45	Reserved	7:0	Reserved	R/W	0x00		Set bits to 0
0x46	Reserved	7:0	Reserved	R/W	0x38		Set bits to 0x38
0x47	Reserved	7:4	Reserved	R/W	0x00		Set bits to 0
		3:0	Reserved			Yes	Set bits to 0
0x48	Reserved	7:6	Reserved	R/W	0x05	Yes	Set bits to 0
		5:0	Reserved	R/W			Set bits to 00 0101'b
0x49- 0x4B	Reserved	7:0	Reserved	R/W	0x00		Set bits to 0
0x4C	Reserved	7:3	Reserved	R/W	0x00	Yes	Set bits to 0
		2:1	Reserved	R/W			Set bits to 0
		0	Reserved	R/W		Yes	Set bits to 0
0x4D- 0x50	Reserved	7:0	Reserved	R/W	0x00		Set bits to 0
0x51	Device ID	7:5	VERSION	R	0x85		100'b
		4:0	ID				0 0101'b
0x52- 0x55	Reserved	7:0	Reserved	R/W	0x00		Set bits to 0
0x56	Reserved	7:0	Reserved	R/W	0x10		Set bits to 0x10
0x57	Reserved	7:0	Reserved	R/W	0x64		Set bits to 0x64
0x58	Reserved	7:0	Reserved	R/W	0x21		Set bits to 0x21
0x59	Reserved	7:1	Reserved	R/W	0x00		Set bits to 0
		0	Reserved			Yes	Set bit to 0
0x5A	Reserved	7:0	Reserved	R/W	0x54	Yes	Set bits to 0x54
0x5B	Reserved	7:0	Reserved	R/W	0x54	Yes	Set bits to 0x54
0x5C- 0x61	Reserved	7:0	Reserved	R/W	0x00		Set bits to 0

8 Applications and Implementation

NOTE

Information in the following applications sections is not part of the TI component specification, and TI does not warrant its accuracy or completeness. TI's customers are responsible for determining suitability of components for their purposes. Customers should validate and test their design implementation to confirm system functionality.

8.1 Application Information

8.1.1 DS80PCI810 versus DS80PCI800

The DS80PCI810 and DS80PCI800 are pin compatible, and both can be used for PCIe Gen-1, 2, and 3 applications. The DS80PCI810 features several design enhancements to improve PCIe system interoperability and performance over the previous generation DS80PCI800 design. The DS80PCI810 has a more linear input equalizer and output driver to enhance signal transparency for protocols requiring link training. This transparency is important, because it preserves subtle pre-cursor and post-cursor information from the Tx signal prior to the repeater. As a result of these enhancements, the DS80PCI810 is easier to tune and increases flexibility of IC placement along the signal path. The DS80PCI810 is ideal for open PCIe systems. An open system is defined as an environment where a PCIe connector accepts any compliant PCIe Add-In Card (AIC). The DS80PCI810 can extend the reach of a PCIe system by up to 10 dB beyond the max allowable PCIe channel loss.

The DS80PCI800 may still be used for closed PCIe systems where significant insertion losses (> 35 dB at 4 GHz) are expected in the signal path. In contrast to open PCIe systems, a closed system is defined as a PCIe environment with a limited number of possible Host-to-Endpoint combinations. Due to larger CTLE gain, the DS80PCI800 is able to compensate insertion loss over longer transmission lines before the repeater. In addition, the DS80PCI800 is able to produce de-emphasis levels up to -12 dB to support significant trace losses after the repeater (-15 dB at 4 GHz).

8.1.2 Signal Integrity in PCIe Applications

In PCIe Gen-3 applications, specifications require Rx-Tx link training to establish and optimize signal conditioning settings at 8 Gbps. In link training, the Rx partner requests a series of FIR coefficients from the Tx partner at speed. This training sequence is designed to pre-condition the signal path with an optimized link between the endpoints. Note that there is no link training with Tx FIR coefficients for PCIe Gen-1 (2.5 Gbps) or PCIe Gen-2 (5.0 Gbps) applications.

The DS80PCI810 works to extend the reach possible by using active linear equalization on the channel, boosting attenuated signals so that they can be more easily recovered at the Rx. The repeater outputs are specially designed to be transparent to Tx FIR signaling in order to pass information critical for optimal link training to the Rx. Suggested settings for the A-channels and B-channels are given in [Table 10](#) and [Table 11](#). Further adjustments to EQx and VODx settings may optimize signal margin on the link for different system applications:

Table 10. Suggested Device Settings in Pin Mode

CHANNEL SETTINGS	PIN MODE
EQx	Level 4
VODx[1:0]	Level 6 (1, 0)

Table 11. Suggested Device Settings in SMBus Modes

CHANNEL SETTINGS	SMBus MODES
EQx	0x03
VODx	110'b
VOD_DB	000'b

The SMBus Slave Mode code example in [Table 12](#) may be used to program the DS80PCI810 with the recommended device settings.

Table 12. SMBus Example Sequence

REGISTER	WRITE VALUE	COMMENTS
0x06	0x18	Set SMBus Slave Mode Register Enable.
0x0F	0x03	Set CHB_0 EQ to 0x03.
0x10	0xAE	Set CHB_0 VOD to 110'b.
0x11	0x00	Set CHB_0 VOD_DB to 000'b.
0x16	0x03	Set CHB_1 EQ to 0x03.
0x17	0xAE	Set CHB_1 VOD to 110'b.
0x18	0x00	Set CHB_1 VOD_DB to 000'b.
0x1D	0x03	Set CHB_2 EQ to 0x03.
0x1E	0xAE	Set CHB_2 VOD to 110'b.
0x1F	0x00	Set CHB_2 VOD_DB to 000'b.
0x24	0x03	Set CHB_3 EQ to 0x03.
0x25	0xAE	Set CHB_3 VOD to 110'b.
0x26	0x00	Set CHB_3 VOD_DB to 000'b.
0x2C	0x03	Set CHA_0 EQ to 0x03.
0x2D	0xAE	Set CHA_0 VOD to 110'b.
0x2E	0x00	Set CHA_0 VOD_DB to 000'b.
0x33	0x03	Set CHA_1 EQ to 0x03.
0x34	0xAE	Set CHA_1 VOD to 110'b.
0x35	0x00	Set CHA_1 VOD_DB to 000'b.
0x3A	0x03	Set CHA_2 EQ to 0x03.
0x3B	0xAE	Set CHA_2 VOD to 110'b.
0x3C	0x00	Set CHA_2 VOD_DB to 000'b.
0x41	0x03	Set CHA_3 EQ to 0x03.
0x42	0xAE	Set CHA_3 VOD to 110'b.
0x43	0x00	Set CHA_3 VOD_DB to 000'b.

8.1.3 Rx Detect Functionality in PCIe Applications

In PCIe systems, specifications require the Tx to implement Rx detection in order to determine whether an Rx endpoint is present. Since the DS80PCI810 is designed for placement between an ASIC Tx and endpoint Rx, the DS80PCI810 implements automatic polling for valid Rx detection when the RXDET pin is left floating or tied low via 20 k Ω to GND. If 50 Ω impedances are seen on both positive and negative outputs of a DS80PCI810 channel, the Rx detect state machine asserts Rx detection, and a 50 Ω termination to VDD is provided at the respective channel's positive and negative input. For open PCIe systems where users may swap multiple cards in and out of a given PCIe slot, it is recommended to keep the RXDET pin floating. For closed systems where an endpoint Rx is present in a PCIe slot at all times, the RXDET pin may be left floating or tied high via 1 k Ω to VDD (2.5 V mode) or VIN (3.3 V mode).

For more details about DS80PCI810 Rx detection, refer to [Table 2](#).

8.2 Typical Applications

8.2.1 Generic High Speed Repeater

The DS80PCI810 extends PCB and cable reach in multiple applications by using active linear equalization. The high linearity of this device aids specifically in protocols requiring link training and can be used in line cards, backplanes, and motherboards, thereby improving margin and overall eye performance. The capability of the repeater can be explored across a range of data rates and ASIC-to-link-partner signaling, as shown in the following two test setup connections.

Typical Applications (continued)

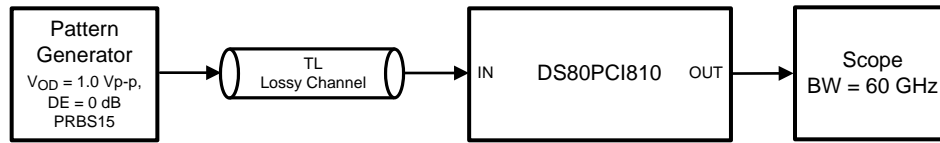

Figure 9. Test Setup Connections Diagram

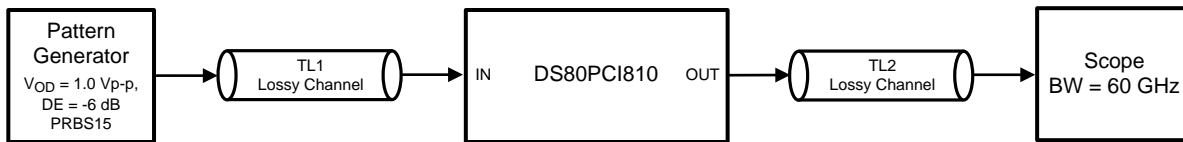

Figure 10. Test Setup Connections Diagram

8.2.1.1 Design Requirements

As with any high speed design, there are many factors that influence the overall performance. Below are a list of critical areas for consideration and study during design.

- Use 100 Ω impedance traces. Generally these are very loosely coupled to ease routing length differences.
- Place AC-coupling capacitors near to the receiver end of each channel segment to minimize reflections.
- The maximum body size for AC-coupling capacitors is 0402.
- Back-drill connector vias and signal vias to minimize stub length.
- Use reference plane vias to ensure a low inductance path for the return current.

8.2.1.2 Detailed Design Procedure

The DS80PCI810 is designed to be placed at an offset location with respect to the overall channel attenuation. In order to optimize performance, the repeater requires tuning to extend the reach of the cable or trace length while also recovering a solid eye opening. To tune the repeater, the settings mentioned in [Table 10](#) (for Pin Mode) and [Table 11](#) (for SMBus Modes) are recommended as a default starting point for most applications. Once these settings are configured, additional tuning of the EQ and, to a lesser extent, VOD may be required to optimize the repeater performance for each specific application environment.

Examples of the repeater performance as a generic high speed datapath repeater are illustrated in the performance curves in the next section.

Typical Applications (continued)

8.2.1.3 Application Performance Plots

8.2.1.3.1 Pre-Channel Only Setup

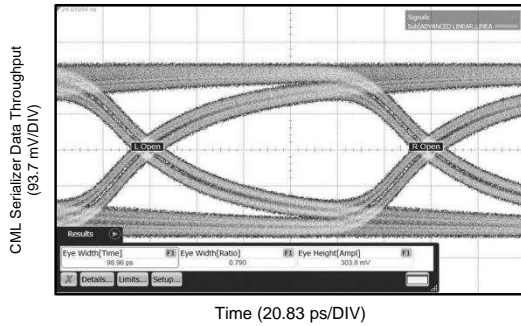

No Repeater Used
TJ (1.0E-12) = 21.6 ps

Figure 11. TL = 5 Inch 5-Mil FR4 Trace, No Repeater, 8 Gbps

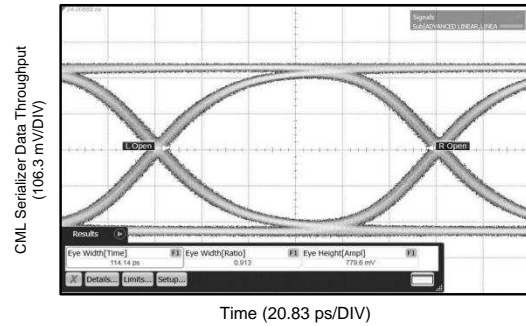

DS80PCI810 Settings: EQA = Level 2, VODA = Level 6
TJ (1.0E-12) = 13.6 ps

Figure 12. TL = 5 Inch 5-Mil FR4 Trace, DS80PCI810 CHA_0, 8 Gbps

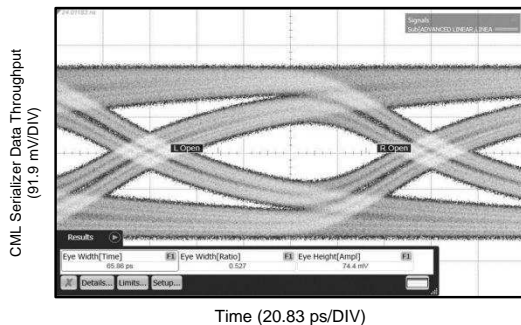

No Repeater Used
TJ (1.0E-12) = 43.7 ps

Figure 13. TL = 10 Inch 5-Mil FR4 Trace, No Repeater, 8 Gbps

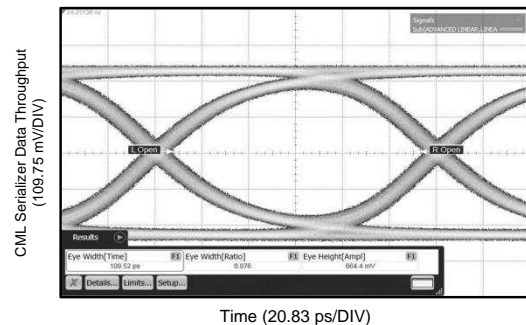

DS80PCI810 Settings: EQA = Level 3, VODA = Level 6
TJ (1.0E-12) = 18.1 ps

Figure 14. TL = 10 Inch 5-Mil FR4 Trace, DS80PCI810 CHA_0, 8 Gbps

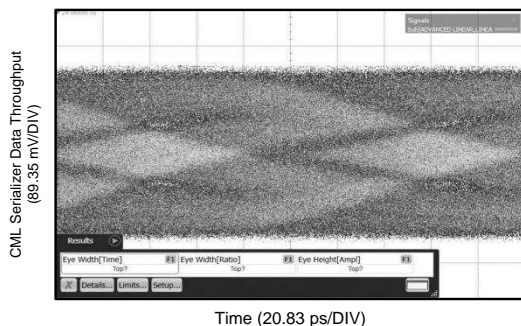

No Repeater Used
TJ (1.0E-12) = Not Available Due to Closed Eye

Figure 15. TL = 20 Inch 5-Mil FR4 Trace, No Repeater, 8 Gbps

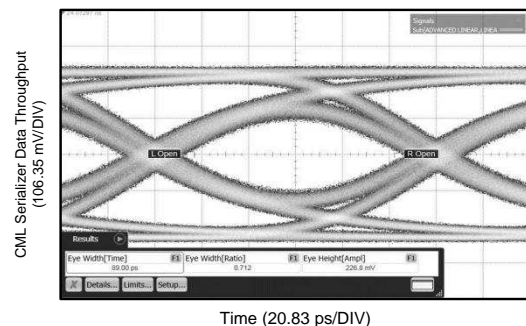

DS80PCI810 Settings: EQA = Level 4, VODA = Level 6
TJ (1.0E-12) = 35.5 ps

Figure 16. TL = 20 Inch 5-Mil FR4 Trace, DS80PCI810 CHA_0, 8 Gbps

Typical Applications (continued)

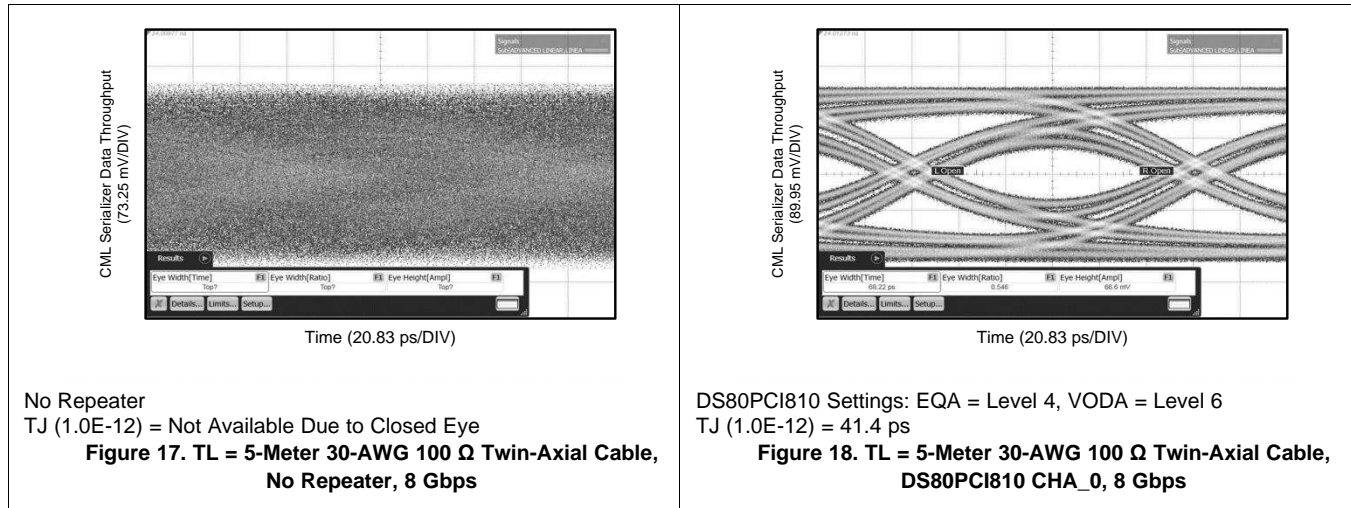

8.2.1.3.2 Pre-Channel and Post-Channel Setup

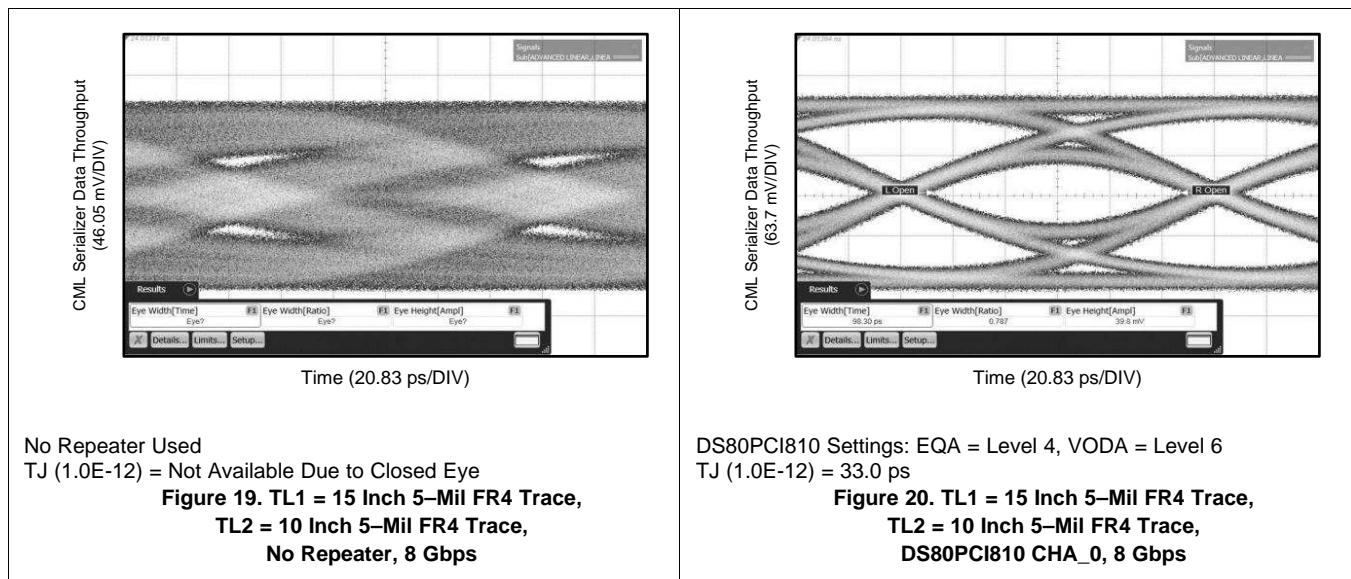

Typical Applications (continued)

8.2.2 PCIe Board Applications (PCIe Gen-3)

The DS80PCI810 can be used to extend trace length on motherboards and line cards in PCIe Gen-3 applications. The high linearity of the DS80PCI810 aids in the link training protocol required by PCIe Gen-3 at 8 Gbps in accordance with PCI-SIG standards. For PCIe Gen-3, preservation of the pre-cursor and post-cursor Tx FIR presets (P0-P10) is crucial to successful signal transmission from motherboard system root complex to line card ASIC or Embedded Processor. Below is a typical example of the DS80PCI810 used in a PCIe application:

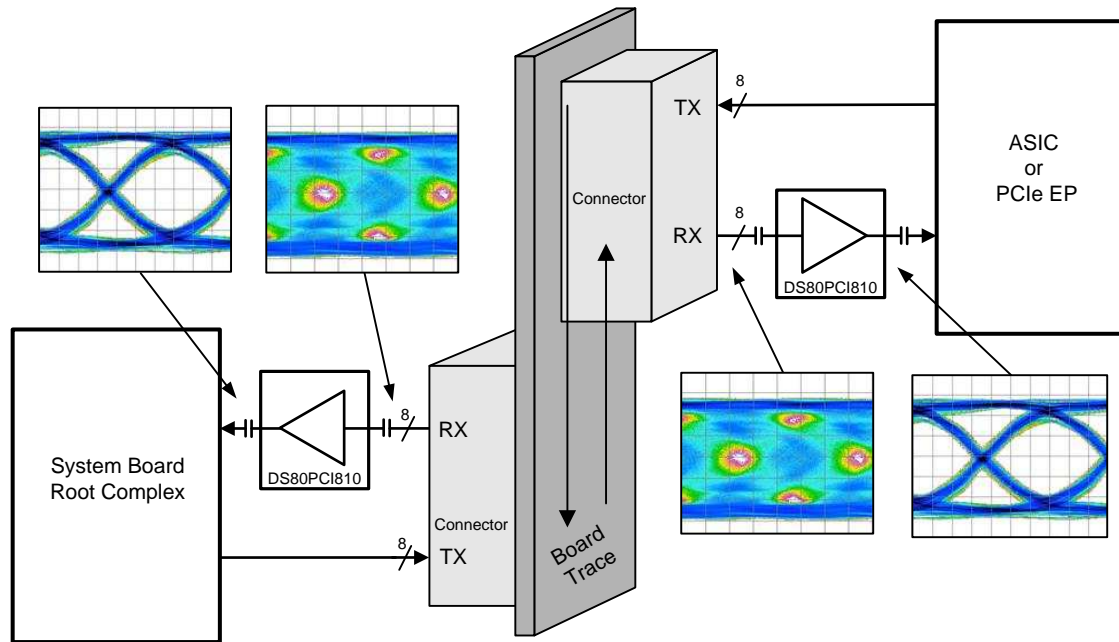

Figure 21. Typical PCIe Gen-3 Configuration Diagram

8.2.2.1 Design Requirements

As with any high speed design, there are many factors that influence the overall performance. Please reference [Design Requirements](#) in the [Generic High Speed Repeater](#) application section for a list of critical areas for consideration and study during design.

8.2.2.2 Design Procedure

In PCIe Gen-3 applications, there is a large range of flexibility regarding the placement of the DS80PCI810 in the signal path due to the high linearity of the device. If the PCIe slot must also support lower speeds like PCIe Gen-1 (2.5 Gbps) and Gen-2 (5.0 Gbps), it is recommended to place the DS80PCI810 closer to the endpoint Rx. Once the DS80PCI810 is placed on the signal path, the repeater must be tuned. To tune the repeater, the settings mentioned in [Table 10](#) (for Pin Mode) and [Table 11](#) (for SMBus Modes) are recommended as a default starting point for most applications. Once these settings are configured, additional tuning of the EQ and, to a lesser extent, VOD may be required to optimize the repeater performance to pass link training preset requirements for PCIe Gen-3.

An example of a test configuration used to evaluate the DS80PCI810 in this application can be seen in [Figure 22](#). For more information about DS80PCI810 PCIe applications, please refer to application note [SNLA227](#).

Typical Applications (continued)

8.2.2.3 Application Performance Plots

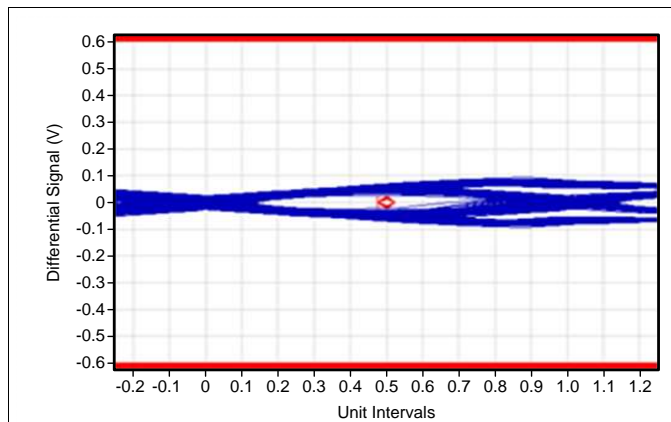

No Repeater Used
 Composite Eye Height: 50.39 mV
 Minimum Eye Width: 49.87 ps
 Overall SigTest Result: Fail

Figure 23. PCIe Gen-3, Preset 7, Transition Eye
 TL1 = 10 Inch 4-Mil FR4 Trace, No TL2
 No Repeater, 8 Gbps

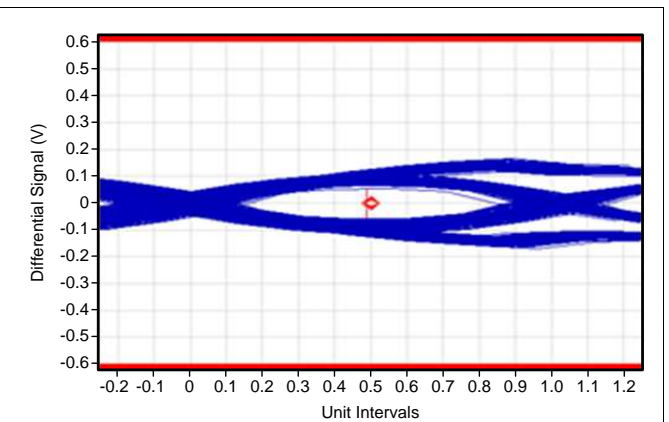

DS80PCI810 Settings: EQA = Level 4, VODA = Level 6
 Composite Eye Height: 112.2 mV
 Minimum Eye Width: 83.82 ps
 Overall SigTest Result: Pass

Figure 24. PCIe Gen-3, Preset 7, Transition Eye
 TL1 = 10 Inch 4-Mil FR4 Trace, No TL2
 DS80PCI810, 8 Gbps

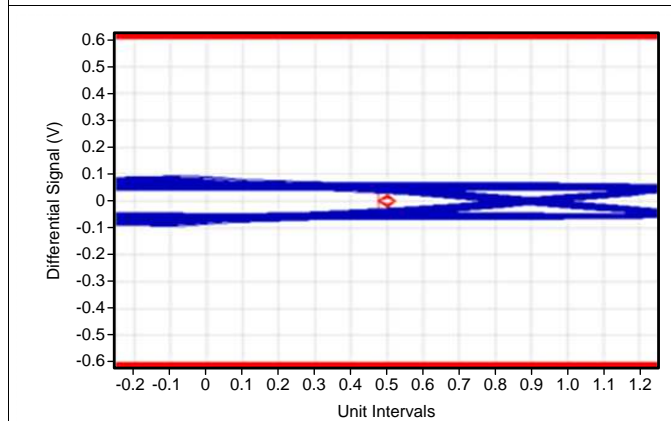

No Repeater Used
 Composite Eye Height: 50.39 mV
 Minimum Eye Width: 49.87 ps
 Overall SigTest Result: Fail

Figure 25. PCIe Gen-3, Preset 7, Non-Transition Eye
 TL1 = 10 Inch 4-Mil FR4 Trace, No TL2
 No Repeater, 8 Gbps

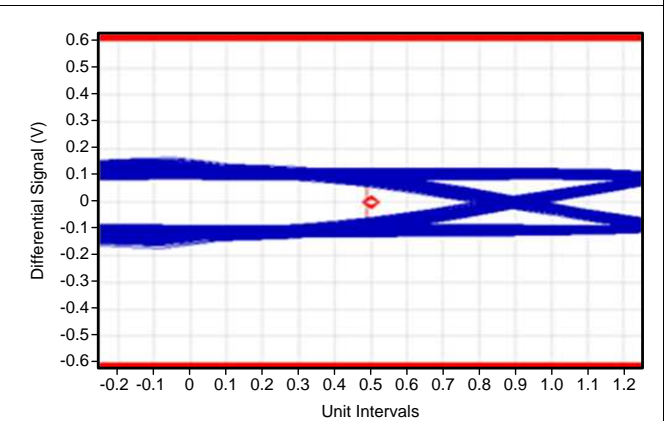

DS80PCI810 Settings: EQA = Level 4, VODA = Level 6
 Composite Eye Height: 112.2 mV
 Minimum Eye Width: 83.82 ps
 Overall SigTest Result: Pass

Figure 26. PCIe Gen-3, Preset 7, Non-Transition Eye
 TL1 = 10 Inch 4-Mil FR4 Trace, No TL2
 DS80PCI810, 8 Gbps

Typical Applications (continued)

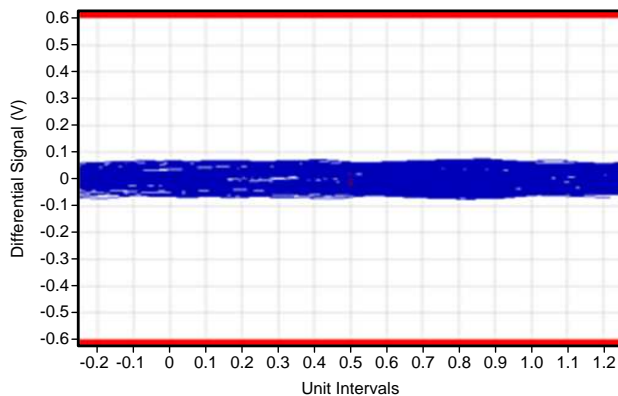

No Repeater Used
 Composite Eye Height: 0.057 mV
 Minimum Eye Width: 37.66 ps
 Overall SigTest Result: Fail

Figure 27. PCIe Gen-3, Preset 7, Transition Eye
 TL1 = 10 Inch 4-Mil FR4 Trace,
 TL2 = 5 Inch 4-Mil FR4 Trace
 No Repeater, 8 Gbps

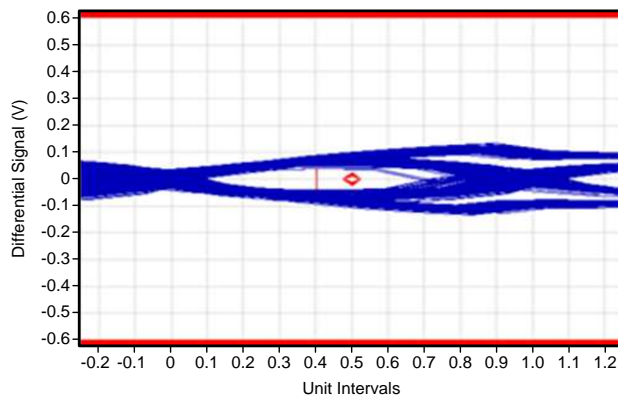

DS80PCI810 Settings: EQA = Level 4, VODA = Level 6
 Composite Eye Height: 77.26 mV
 Minimum Eye Width: 78.24 ps
 Overall SigTest Result: Pass

Figure 28. PCIe Gen-3, Preset 7, Transition Eye
 TL1 = 10 Inch 4-Mil FR4 Trace,
 TL2 = 5 Inch 4-Mil FR4 Trace
 DS80PCI810, 8 Gbps

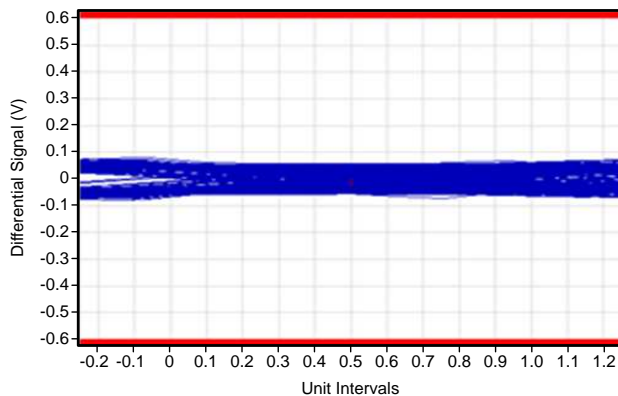

No Repeater Used
 Composite Eye Height: 0.057 mV
 Minimum Eye Width: 37.66 ps
 Overall SigTest Result: Fail

Figure 29. PCIe Gen-3, Preset 7, Non-Transition Eye
 TL1 = 10 Inch 4-Mil FR4 Trace,
 TL2 = 5 Inch 4-Mil FR4 Trace
 No Repeater, 8 Gbps

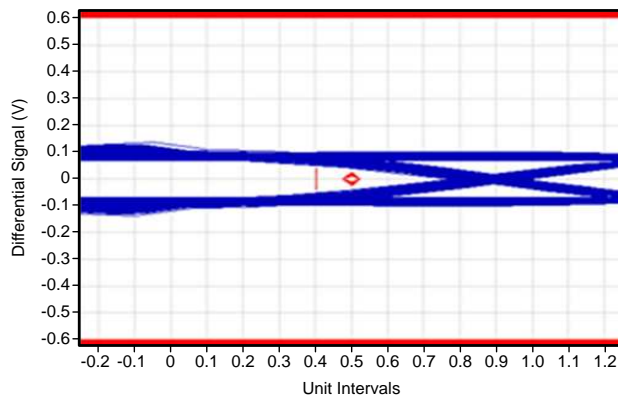

DS80PCI810 Settings: EQA = Level 4, VODA = Level 6
 Composite Eye Height: 77.26 mV
 Minimum Eye Width: 78.24 ps
 Overall SigTest Result: Pass

Figure 30. PCIe Gen-3, Preset 7, Non-Transition Eye
 TL1 = 10 Inch 4-Mil FR4 Trace,
 TL2 = 5 Inch 4-Mil FR4 Trace
 DS80PCI810, 8 Gbps

9 Power Supply Recommendations

Two approaches are recommended to ensure that the DS80PCI810 is provided with an adequate power supply. First, the supply (VDD) and ground (GND) pins should be connected to power planes routed on adjacent layers of the printed circuit board. The layer thickness of the dielectric should be minimized so that the VDD and GND planes create a low inductance supply with distributed capacitance. Second, careful attention to supply bypassing through the proper use of bypass capacitors is required. A 0.1 μF bypass capacitor should be connected to each VDD pin such that the capacitor is placed as close as possible to the DS80PCI810. Smaller body size capacitors can help facilitate proper component placement. Additionally, capacitor with capacitance in the range of 1 μF to 10 μF should be incorporated in the power supply bypassing design as well. These capacitors can be either tantalum or an ultra-low ESR ceramic.

The DS80PCI810 has an optional internal voltage regulator to provide the 2.5 V supply to the device. In 3.3 V mode operation, the VIN pin = 3.3 V is used to supply power to the device. The internal regulator then provides the 2.5 V to the VDD pins of the device, and a 0.1 μF cap is needed at each of the five VDD pins for power supply de-coupling (total capacitance should equal 0.5 μF). The VDD_SEL pin must be tied to GND to enable the internal regulator. In 2.5 V mode operation, the VIN pin should be left open and 2.5 V supply must be applied to the five VDD pins to power the device. The VDD_SEL pin must be left open (no connect) to disable the internal regulator.

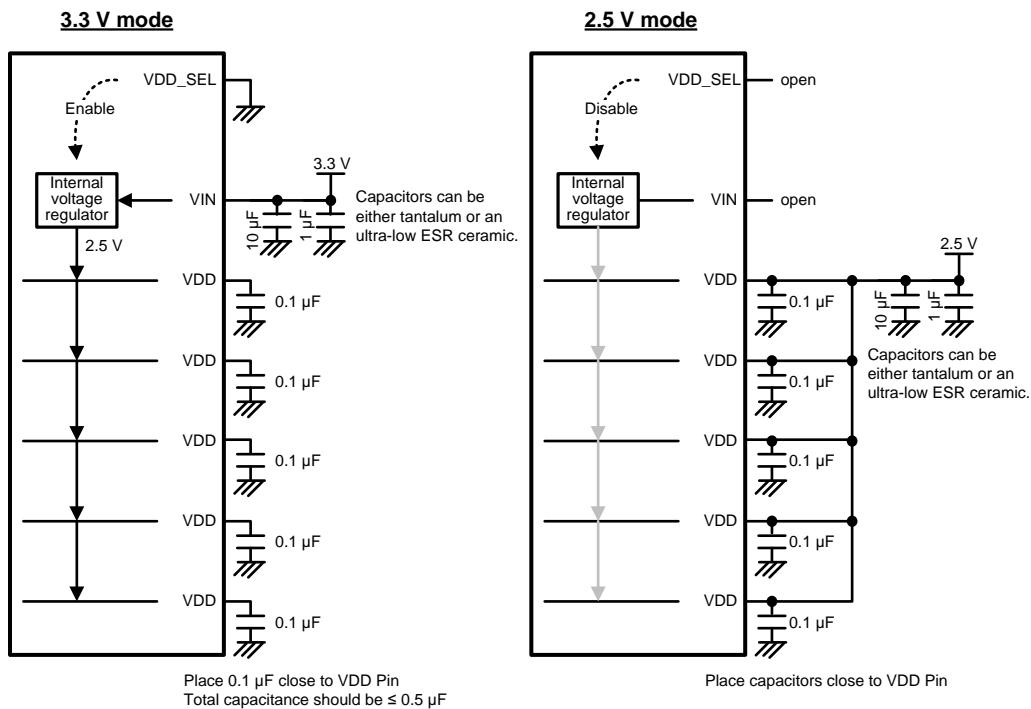

Figure 31. 3.3 V or 2.5 V Supply Connection Diagram

10 Layout

10.1 Layout Guidelines

The CML inputs and outputs have been optimized to work with interconnects using a controlled differential impedance of 100 Ω. It is preferable to route differential lines exclusively on one layer of the board, particularly for the input traces. The use of vias should be avoided if possible. If vias must be used, they should be used sparingly and must be placed symmetrically for each side of a given differential pair. Whenever differential vias are used, the layout must also provide for a low inductance path for the return currents as well. Route the differential signals away from other signals and noise sources on the printed circuit board. To minimize the effects of crosstalk, a 5:1 ratio or greater should be maintained between inter-pair and intra-pair spacing. See AN-1187 “Leadless Leadframe Package (LLP) Application Report” (literature number [SNOA401](#)) for additional information on QFN (WQFN) packages.

10.2 Layout Example

Figure 32 depicts different transmission line topologies which can be used in various combinations to achieve the optimal system performance. Impedance discontinuities at the differential via can be minimized or eliminated by increasing the swell around each hole and by providing for a low inductance return current path. When the via structure is associated with a thick backplane PCB, further optimization such as back drilling is often used to reduce the detrimental high frequency effects of stubs on the signal path.

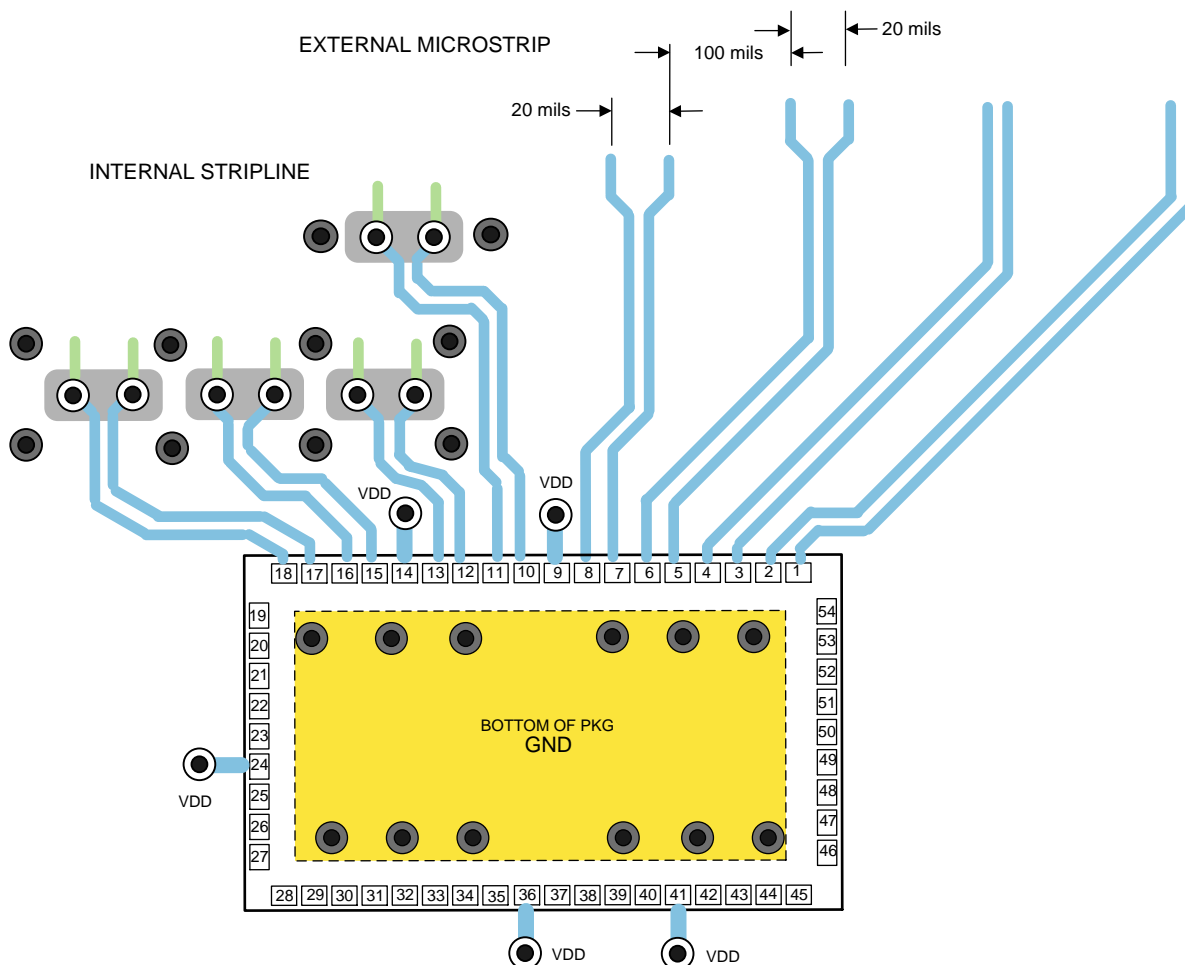

Figure 32. Typical Routing Options

11 Device and Documentation Support

11.1 Trademarks

All trademarks are the property of their respective owners.

11.2 Electrostatic Discharge Caution



These devices have limited built-in ESD protection. The leads should be shorted together or the device placed in conductive foam during storage or handling to prevent electrostatic damage to the MOS gates.

11.3 Glossary

[SLYZ022](#) — *TI Glossary*.

This glossary lists and explains terms, acronyms, and definitions.

12 Mechanical, Packaging, and Orderable Information

The following pages include mechanical, packaging, and orderable information. This information is the most current data available for the designated devices. This data is subject to change without notice and revision of this document. For browser-based versions of this data sheet, refer to the left-hand navigation.

PACKAGING INFORMATION

Orderable Device	Status (1)	Package Type	Package Drawing	Pins	Package Qty	Eco Plan (2)	Lead/Ball Finish (6)	MSL Peak Temp (3)	Op Temp (°C)	Device Marking (4/5)	Samples
DS80PCI810NJYR	ACTIVE	WQFN	NJY	54	2000	Green (RoHS & no Sb/Br)	CU SN	Level-2-260C-1 YEAR	-40 to 85	80PCI810A0	Samples
DS80PCI810NJYT	ACTIVE	WQFN	NJY	54	250	Green (RoHS & no Sb/Br)	CU SN	Level-2-260C-1 YEAR	-40 to 85	80PCI810A0	Samples

(1) The marketing status values are defined as follows:

ACTIVE: Product device recommended for new designs.

LIFEBUY: TI has announced that the device will be discontinued, and a lifetime-buy period is in effect.

NRND: Not recommended for new designs. Device is in production to support existing customers, but TI does not recommend using this part in a new design.

PREVIEW: Device has been announced but is not in production. Samples may or may not be available.

OBsolete: TI has discontinued the production of the device.

(2) Eco Plan - The planned eco-friendly classification: Pb-Free (RoHS), Pb-Free (RoHS Exempt), or Green (RoHS & no Sb/Br) - please check <http://www.ti.com/productcontent> for the latest availability information and additional product content details.

TBD: The Pb-Free/Green conversion plan has not been defined.

Pb-Free (RoHS): TI's terms "Lead-Free" or "Pb-Free" mean semiconductor products that are compatible with the current RoHS requirements for all 6 substances, including the requirement that lead not exceed 0.1% by weight in homogeneous materials. Where designed to be soldered at high temperatures, TI Pb-Free products are suitable for use in specified lead-free processes.

Pb-Free (RoHS Exempt): This component has a RoHS exemption for either 1) lead-based flip-chip solder bumps used between the die and package, or 2) lead-based die adhesive used between the die and leadframe. The component is otherwise considered Pb-Free (RoHS compatible) as defined above.

Green (RoHS & no Sb/Br): TI defines "Green" to mean Pb-Free (RoHS compatible), and free of Bromine (Br) and Antimony (Sb) based flame retardants (Br or Sb do not exceed 0.1% by weight in homogeneous material)

(3) MSL, Peak Temp. - The Moisture Sensitivity Level rating according to the JEDEC industry standard classifications, and peak solder temperature.

(4) There may be additional marking, which relates to the logo, the lot trace code information, or the environmental category on the device.

(5) Multiple Device Markings will be inside parentheses. Only one Device Marking contained in parentheses and separated by a "~" will appear on a device. If a line is indented then it is a continuation of the previous line and the two combined represent the entire Device Marking for that device.

(6) Lead/Ball Finish - Orderable Devices may have multiple material finish options. Finish options are separated by a vertical ruled line. Lead/Ball Finish values may wrap to two lines if the finish value exceeds the maximum column width.

Important Information and Disclaimer: The information provided on this page represents TI's knowledge and belief as of the date that it is provided. TI bases its knowledge and belief on information provided by third parties, and makes no representation or warranty as to the accuracy of such information. Efforts are underway to better integrate information from third parties. TI has taken and continues to take reasonable steps to provide representative and accurate information but may not have conducted destructive testing or chemical analysis on incoming materials and chemicals. TI and TI suppliers consider certain information to be proprietary, and thus CAS numbers and other limited information may not be available for release.

In no event shall TI's liability arising out of such information exceed the total purchase price of the TI part(s) at issue in this document sold by TI to Customer on an annual basis.

TAPE AND REEL INFORMATION

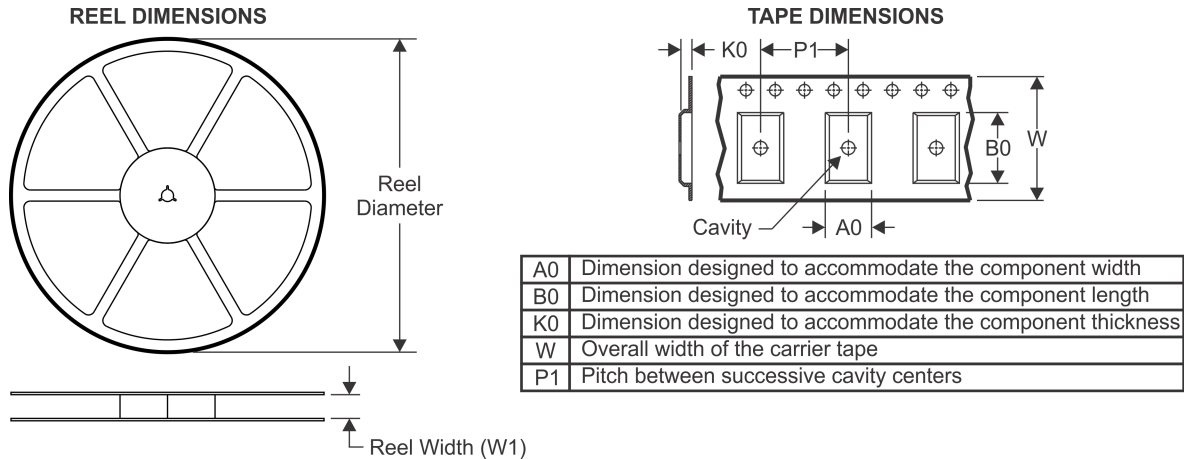

QUADRANT ASSIGNMENTS FOR PIN 1 ORIENTATION IN TAPE



*All dimensions are nominal

Device	Package Type	Package Drawing	Pins	SPQ	Reel Diameter (mm)	Reel Width W1 (mm)	A0 (mm)	B0 (mm)	K0 (mm)	P1 (mm)	W (mm)	Pin1 Quadrant
DS80PCI810NJYR	WQFN	NJY	54	2000	330.0	16.4	5.8	10.3	1.0	12.0	16.0	Q1
DS80PCI810NJYT	WQFN	NJY	54	250	178.0	16.4	5.8	10.3	1.0	12.0	16.0	Q1

TAPE AND REEL BOX DIMENSIONS

*All dimensions are nominal

Device	Package Type	Package Drawing	Pins	SPQ	Length (mm)	Width (mm)	Height (mm)
DS80PCI810NJYR	WQFN	NJY	54	2000	367.0	367.0	38.0
DS80PCI810NJYT	WQFN	NJY	54	250	213.0	191.0	55.0

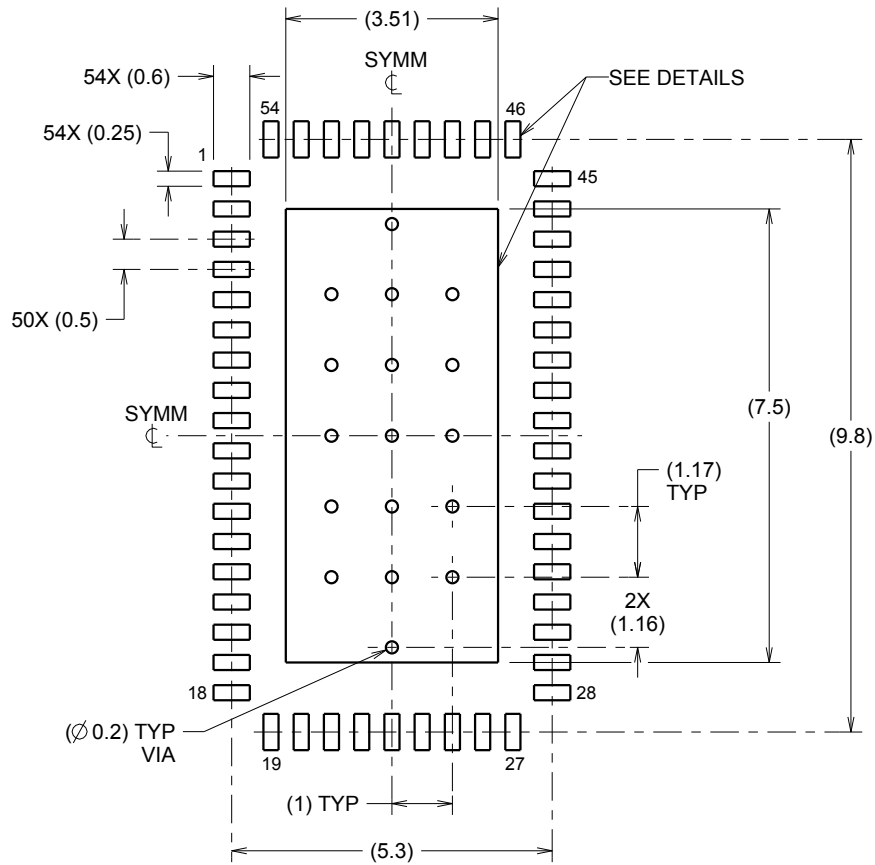

LAND PATTERN EXAMPLE
SCALE:8X

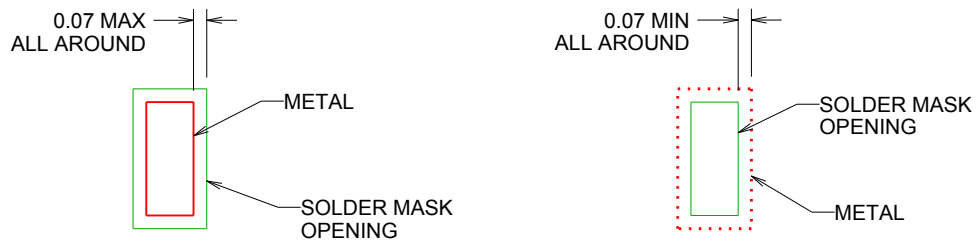

SOLDER MASK DETAILS

4214993/A 07/2013

NOTES: (continued)

- This package is designed to be soldered to a thermal pad on the board. For more information, refer to QFN/SON PCB application note in literature No. SLUA271 (www.ti.com/lit/slua271).

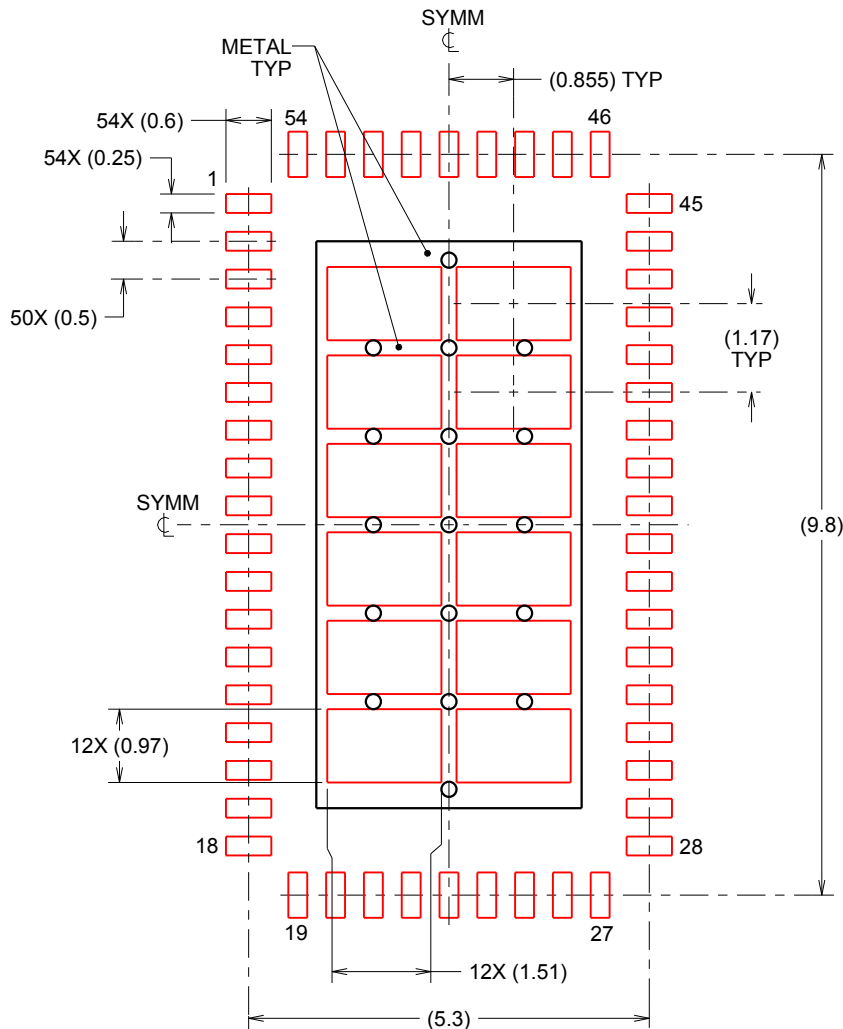

SOLDERPASTE EXAMPLE
 BASED ON 0.125mm THICK STENCIL

EXPOSED PAD
 67% PRINTED SOLDER COVERAGE BY AREA
 SCALE:10X

4214993/A 07/2013

NOTES: (continued)

5. Laser cutting apertures with trapezoidal walls and rounded corners may offer better paste release. IPC-7525 may have alternate design recommendations.

IMPORTANT NOTICE

Texas Instruments Incorporated and its subsidiaries (TI) reserve the right to make corrections, enhancements, improvements and other changes to its semiconductor products and services per JESD46, latest issue, and to discontinue any product or service per JESD48, latest issue. Buyers should obtain the latest relevant information before placing orders and should verify that such information is current and complete. All semiconductor products (also referred to herein as "components") are sold subject to TI's terms and conditions of sale supplied at the time of order acknowledgment.

TI warrants performance of its components to the specifications applicable at the time of sale, in accordance with the warranty in TI's terms and conditions of sale of semiconductor products. Testing and other quality control techniques are used to the extent TI deems necessary to support this warranty. Except where mandated by applicable law, testing of all parameters of each component is not necessarily performed.

TI assumes no liability for applications assistance or the design of Buyers' products. Buyers are responsible for their products and applications using TI components. To minimize the risks associated with Buyers' products and applications, Buyers should provide adequate design and operating safeguards.

TI does not warrant or represent that any license, either express or implied, is granted under any patent right, copyright, mask work right, or other intellectual property right relating to any combination, machine, or process in which TI components or services are used. Information published by TI regarding third-party products or services does not constitute a license to use such products or services or a warranty or endorsement thereof. Use of such information may require a license from a third party under the patents or other intellectual property of the third party, or a license from TI under the patents or other intellectual property of TI.

Reproduction of significant portions of TI information in TI data books or data sheets is permissible only if reproduction is without alteration and is accompanied by all associated warranties, conditions, limitations, and notices. TI is not responsible or liable for such altered documentation. Information of third parties may be subject to additional restrictions.

Resale of TI components or services with statements different from or beyond the parameters stated by TI for that component or service voids all express and any implied warranties for the associated TI component or service and is an unfair and deceptive business practice. TI is not responsible or liable for any such statements.

Buyer acknowledges and agrees that it is solely responsible for compliance with all legal, regulatory and safety-related requirements concerning its products, and any use of TI components in its applications, notwithstanding any applications-related information or support that may be provided by TI. Buyer represents and agrees that it has all the necessary expertise to create and implement safeguards which anticipate dangerous consequences of failures, monitor failures and their consequences, lessen the likelihood of failures that might cause harm and take appropriate remedial actions. Buyer will fully indemnify TI and its representatives against any damages arising out of the use of any TI components in safety-critical applications.

In some cases, TI components may be promoted specifically to facilitate safety-related applications. With such components, TI's goal is to help enable customers to design and create their own end-product solutions that meet applicable functional safety standards and requirements. Nonetheless, such components are subject to these terms.

No TI components are authorized for use in FDA Class III (or similar life-critical medical equipment) unless authorized officers of the parties have executed a special agreement specifically governing such use.

Only those TI components which TI has specifically designated as military grade or "enhanced plastic" are designed and intended for use in military/aerospace applications or environments. Buyer acknowledges and agrees that any military or aerospace use of TI components which have **not** been so designated is solely at the Buyer's risk, and that Buyer is solely responsible for compliance with all legal and regulatory requirements in connection with such use.

TI has specifically designated certain components as meeting ISO/TS16949 requirements, mainly for automotive use. In any case of use of non-designated products, TI will not be responsible for any failure to meet ISO/TS16949.

Products

Audio	www.ti.com/audio
Amplifiers	amplifier.ti.com
Data Converters	dataconverter.ti.com
DLP® Products	www.dlp.com
DSP	dsp.ti.com
Clocks and Timers	www.ti.com/clocks
Interface	interface.ti.com
Logic	logic.ti.com
Power Mgmt	power.ti.com
Microcontrollers	microcontroller.ti.com
RFID	www.ti-rfid.com
OMAP Applications Processors	www.ti.com/omap
Wireless Connectivity	www.ti.com/wirelessconnectivity

Applications

Automotive and Transportation	www.ti.com/automotive
Communications and Telecom	www.ti.com/communications
Computers and Peripherals	www.ti.com/computers
Consumer Electronics	www.ti.com/consumer-apps
Energy and Lighting	www.ti.com/energy
Industrial	www.ti.com/industrial
Medical	www.ti.com/medical
Security	www.ti.com/security
Space, Avionics and Defense	www.ti.com/space-avionics-defense
Video and Imaging	www.ti.com/video

TI E2E Community

e2e.ti.com