



# DS35-B15821

Dx35

MID RANGE DISTANCE SENSORS

**SICK**  
Sensor Intelligence.



### Ordering information

Type	Part no.
DS35-B15821	1057656

Other models and accessories → [www.sick.com/Dx35](http://www.sick.com/Dx35)



### Detailed technical data

#### Mechanics/electronics

<b>Supply voltage <math>V_s</math></b>	DC 12 V ... 30 V <sup>1) 2)</sup>
<b>Ripple</b>	$\leq 5 V_{pp}$ <sup>3)</sup>
<b>Power consumption</b>	$\leq 1.7 W$ <sup>4) 5)</sup>
<b>Initialization time</b>	$\leq 500$ ms
<b>Warm-up time</b>	$\leq 20$ min
<b>Housing material</b>	Plastic (ABS and PC) Acrylic glass (PMMA)
<b>Connection type</b>	Male connector, M12, 5-pin
<b>Indication</b>	LEDs
<b>Weight</b>	65 g
<b>Enclosure rating</b>	IP65 IP67
<b>Protection class</b>	III

<sup>1)</sup> Limit values, reverse-polarity protected, operation in short-circuit protected network: max. 8 A.

<sup>2)</sup> When using IO-Link output  $V_s > 18$  V.

<sup>3)</sup> May not fall short of or exceed  $V_s$  tolerances.

<sup>4)</sup> At 20 °C.

<sup>5)</sup> Without load.

## Performance

<b>Measuring range</b>	50 mm ... 12,000 mm, 90 % remission <sup>1) 2)</sup> 50 mm ... 5,300 mm, 18 % remission 50 mm ... 3,100 mm, 6 % remission
<b>Target</b>	Natural objects
<b>Resolution</b>	0.1 mm
<b>Repeatability</b>	≥ 0.5 mm <sup>2) 3) 4)</sup>
<b>Accuracy</b>	Typ. ± 10 mm <sup>4)</sup>
<b>Response time</b>	2.5 ms ... 96.5 ms, 2.5 ms / 6.5 ms / 12.5 ms / 24.5 ms / 96.5 ms <sup>5) 6)</sup>
<b>Switching frequency</b>	333 Hz / 100 Hz / 50 Hz / 25 Hz / 6 Hz <sup>5) 6)</sup>
<b>Output time</b>	1 ms ... 32 ms, 1 ms/2 ms/4 ms/8 ms/32 ms <sup>5) 7)</sup>
<b>Light source</b>	Laser, infrared <sup>8)</sup>
<b>Laser class</b>	1 (IEC 60825-1:2014, EN 60825-1:2014)
<b>Typ. light spot size (distance)</b>	15 mm x 15 mm (at 2 m)
<b>Additional function</b>	Set speed: Super Fast ... Super Slow, Switching mode: Distance to Object (DtO) / switching window / object between sensor and background (ObSB), teach-in of digital output and digital output invertible, Multifunctional input: laser off / external teach / deactivated, reset to factory default
<b>Average laser service life (at 25 °C)</b>	100,000 h

<sup>1)</sup> For speed setting Slow.

<sup>2)</sup> See repeatability characteristic lines.

<sup>3)</sup> Equivalent to 1  $\sigma$ .

<sup>4)</sup> 6 % ... 90 % remission.

<sup>5)</sup> Depending on the set speed: Super Fast ... Super Slow.

<sup>6)</sup> Lateral entry of the object into the measuring range.

<sup>7)</sup> Continuous change of distance in measuring range.

<sup>8)</sup> Wavelength: 827 nm; max. output: 130 mW; pulse duration: 3.5 ns; duty cycle: 1/250.

## Interfaces

<b>IO-Link</b>	✓, V1.0
Function	Process data, parameterization, diagnosis
Data transmission rate	38.4 kbit/s
<b>Digital output</b>	
Number	2 <sup>1) 2)</sup>
Type	Push-pull: PNP/NPN
Function	Output Q <sub>2</sub> , adaptable: digital output/Q <sub>1</sub> not/deactivated
Maximum output current I <sub>A</sub>	≤ 100 mA
<b>Multifunctional input (MF)</b>	1 x <sup>3)</sup>
<b>Hysteresis</b>	0 mm ... 11,950 mm <sup>4)</sup>

<sup>1)</sup> Output Q short-circuit protected.

<sup>2)</sup> Voltage drop < 3 V.

<sup>3)</sup> Response time ≤ 60 ms.

<sup>4)</sup> Configurable via IO-Link.

## Ambient data

<b>Ambient temperature operation</b>	-30 °C ... +55 °C, U <sub>v</sub> ≤ 24 V
<b>Ambient storage temperature</b>	-40 °C ... +75 °C

<b>Typ. Ambient light immunity</b>	40,000 lx
<b>Vibration resistance</b>	EN 60068-2-6, EN 60068-2-64
<b>Shock resistance</b>	EN 60068-2-27

### Classifications

<b>ECl@ss 5.0</b>	27270801
<b>ECl@ss 5.1.4</b>	27270801
<b>ECl@ss 6.0</b>	27270801
<b>ECl@ss 6.2</b>	27270801
<b>ECl@ss 7.0</b>	27270801
<b>ECl@ss 8.0</b>	27270801
<b>ECl@ss 8.1</b>	27270801
<b>ECl@ss 9.0</b>	27270801
<b>ETIM 5.0</b>	EC001825
<b>ETIM 6.0</b>	EC001825
<b>UNSPSC 16.0901</b>	41111613

### Dimensional drawing (Dimensions in mm (inch))

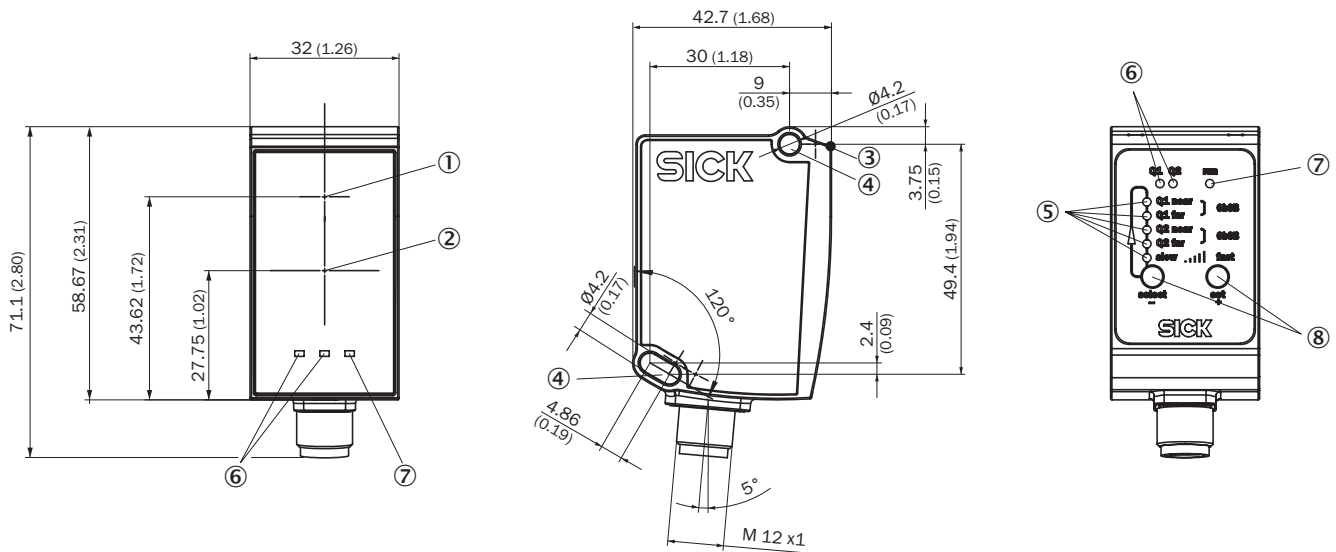

- ① Optical axis, sender
- ② Optical axis, receiver
- ③ Zero level
- ④ Mounting hole M4
- ⑤ Status indicator output Qa/Q2
- ⑥ Status LEDs output Q<sub>1</sub>
- ⑦ Operating indicator
- ⑧ Operating elements

### Connection type

Male connector M12, 5-pin

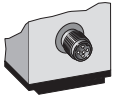

### Connection diagram

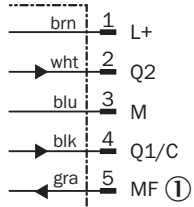

① Multifunctional input (MF)

### Repeatability

Characteristic curve 1) Super Slow

#### Super Slow

Repeatability in mm (inch)

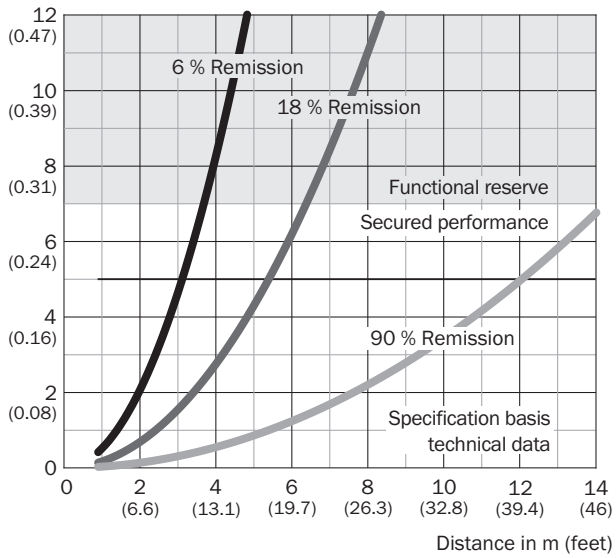

Characteristic curve 5) Super Fast

**Super Fast**

Repeatability in mm (inch)

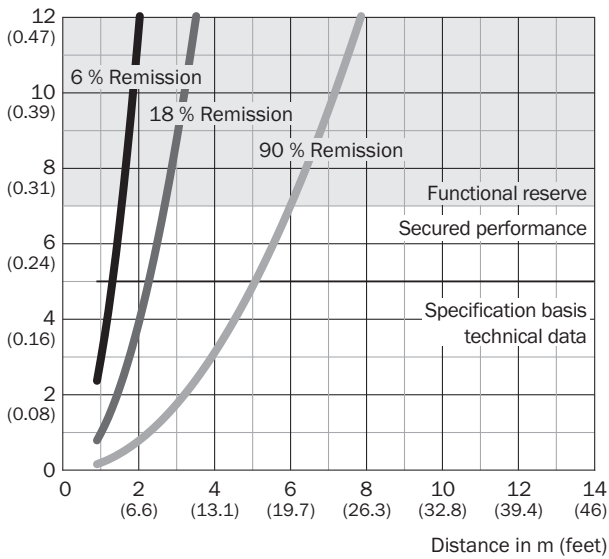

Characteristic curve 2) Slow

**Slow**

Repeatability in mm (inch)

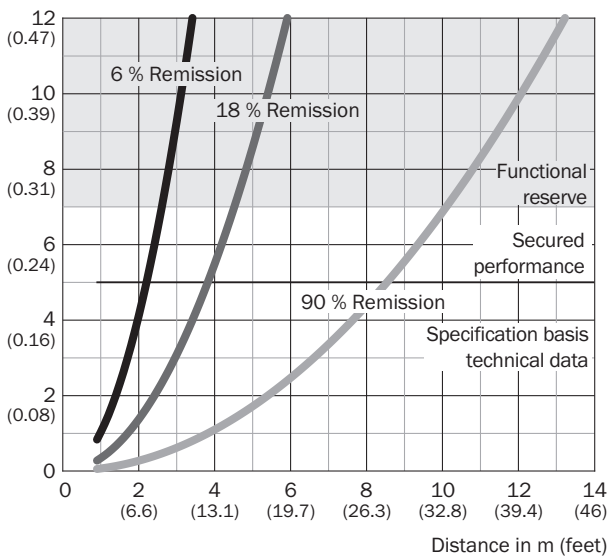

Characteristic curve 3) Medium

**Medium**

Repeatability in mm (inch)

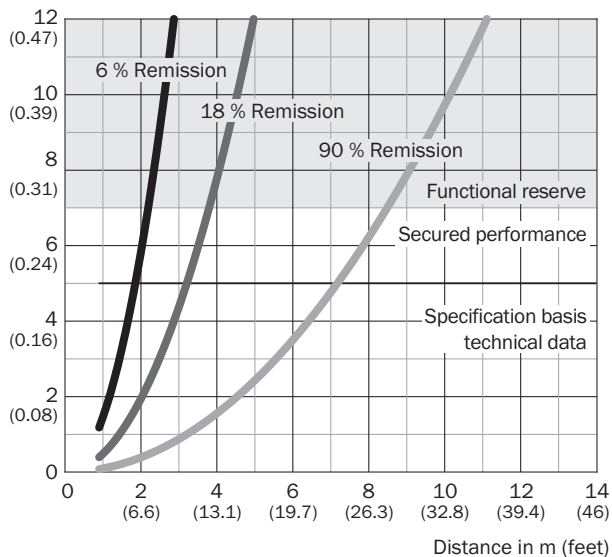

Characteristic curve 4) Fast





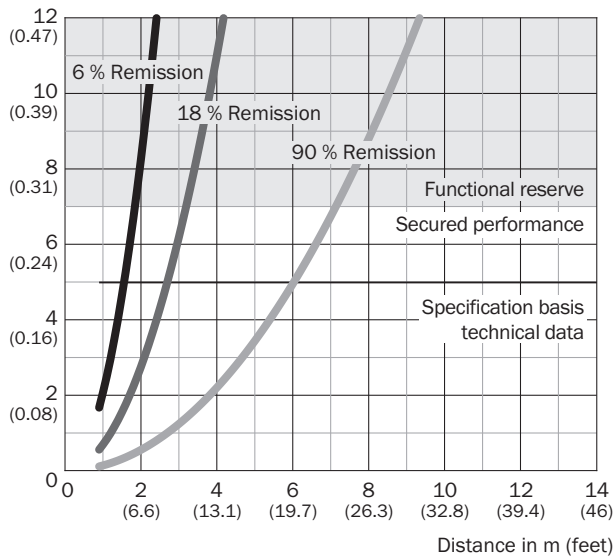

**Fast**

Repeatability in mm (inch)



### Recommended accessories

Other models and accessories → [www.sick.com/Dx35](http://www.sick.com/Dx35)

	Brief description	Type	Part no.
<b>Universal bar clamp systems</b>			
	Plate N02 for universal clamp bracket, Zinc plated steel (sheet), Zinc die cast (clamping bracket), Universal clamp (5322626), mounting hardware	BEF-KHS-N02	2051608
<b>Mounting brackets and plates</b>			
	Mounting bracket: horizontal sending axis for ceiling or floor installation or vertical sending axis for wall installation, steel, zinc coated, incl. mounting material, steel, zinc coated, mounting hardware for the sensor included	BEF-WN-DX35	2069592
<b>Terminal and alignment brackets</b>			
	Alignment unit, steel, zinc coated, mounting hardware for the sensor included	BEF-AH-DX50	2048397
<b>Plug connectors and cables</b>			
	Head A: female connector, M12, 5-pin, straight, A-coded Head B: Flying leads Cable: Sensor/actuator cable, PVC, unshielded, 2 m	YF2A15-020VB5XLEAX	2096239
	Head A: female connector, M12, 5-pin, angled, A-coded Head B: Flying leads Cable: Sensor/actuator cable, PVC, unshielded, 2 m	YG2A15-020VB5XLEAX	2096215
	Head A: female connector, M12, 5-pin, straight, A-coded Head B: male connector, M12, 5-pin, straight, A-coded Cable: Sensor/actuator cable, PUR, halogen-free, unshielded, 2 m	YF2A15-020UB5M2A15	2096009

### Recommended services

Additional services → [www.sick.com/Dx35](http://www.sick.com/Dx35)

	Type	Part no.
<b>Warranty extensions</b>		
<ul style="list-style-type: none"> <li>• <b>Product area:</b> Identification solutions, Vision, Distance sensors, Detection and ranging solutions</li> <li>• <b>Range of services:</b> The services correspond to the scope of the statutory manufacturer warranty (SICK general terms and conditions of purchase), Long-term protection for calculable lump sum.</li> <li>• <b>Duration:</b> Five-year warranty from date of purchase.</li> </ul>	Five-year extended warranty	1680671

## SICK AT A GLANCE

SICK is one of the leading manufacturers of intelligent sensors and sensor solutions for industrial applications. A unique range of products and services creates the perfect basis for controlling processes securely and efficiently, protecting individuals from accidents and preventing damage to the environment.

We have extensive experience in a wide range of industries and understand their processes and requirements. With intelligent sensors, we can deliver exactly what our customers need. In application centers in Europe, Asia and North America, system solutions are tested and optimized in accordance with customer specifications. All this makes us a reliable supplier and development partner.

Comprehensive services complete our offering: SICK LifeTime Services provide support throughout the machine life cycle and ensure safety and productivity.

For us, that is “Sensor Intelligence.”

## WORLDWIDE PRESENCE:

Contacts and other locations –[www.sick.com](http://www.sick.com)