

Cascade Series Thermoelectric Cooler Assembly

The DAC-060-24-02 is a thermoelectric assembly (TEA) that offers dependable, compact performance by cooling objects via convection or conduction. Heat is absorbed and dissipated thru high density heat exchangers equipped with air ducted shrouds and brand name fans. The heat pumping action is created by thermoelectric modules that are custom designed multistage cascades to achieve a high temperature differential. Custom configurations are available, however MOQ applies. This product can produce up to 40% more cooling capacity at cold temperatures, surpassing standard product offerings with similar form factors.

Features

- High heat pumping capacity at cold temperatures
- Precise temperature control
- Reliable solid-state operation
- Compact design

Applications

- Thermoelectric Cooling for CMOS Sensors
- Heads-Up Displays, Imaging Sensors

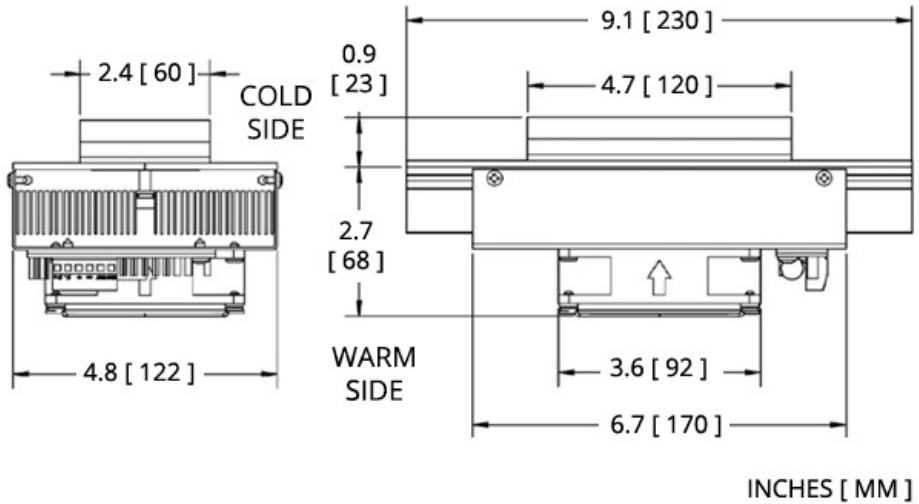
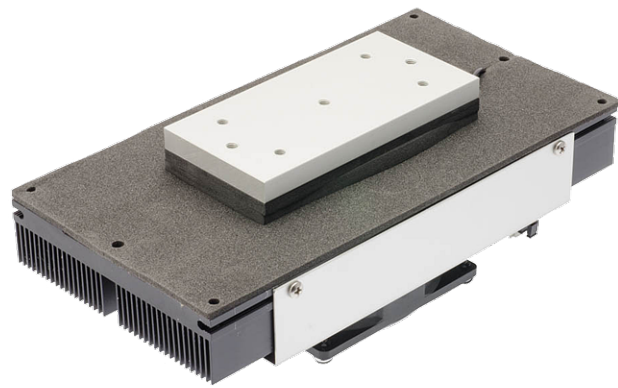

ELECTRICAL AND THERMAL PERFORMANCE

Heat Pumped at Cold Side (Q_c)
 Tambient = 35°C | Tcontrol = 20°C

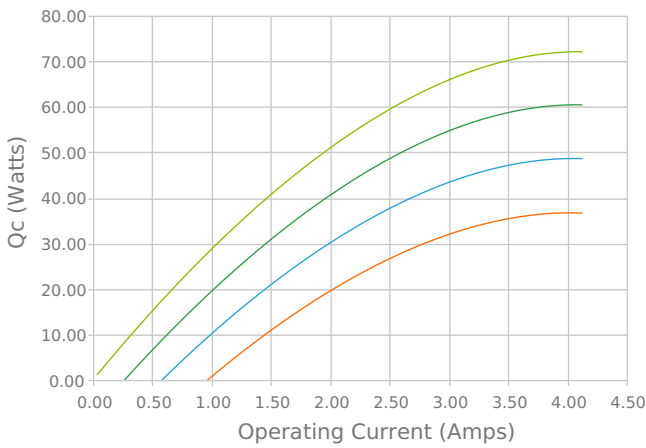

Heat Pumped at Cold Side (Q_c)
 Tambient = 35°C | Tcontrol = 20°C

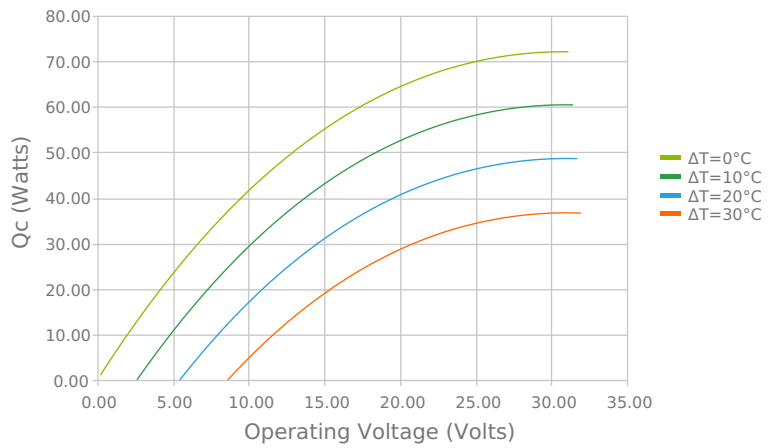

Coefficient of Performance (COP = Qc/Pin)
 Tambient = 35°C | Tcontrol = 20°C

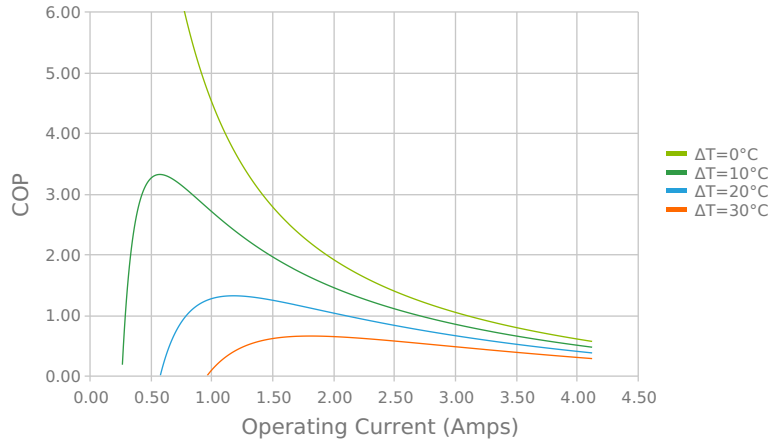

Coefficient of Performance (COP = Qc/Pin)
 Tambient = 35°C | Tcontrol = 20°C

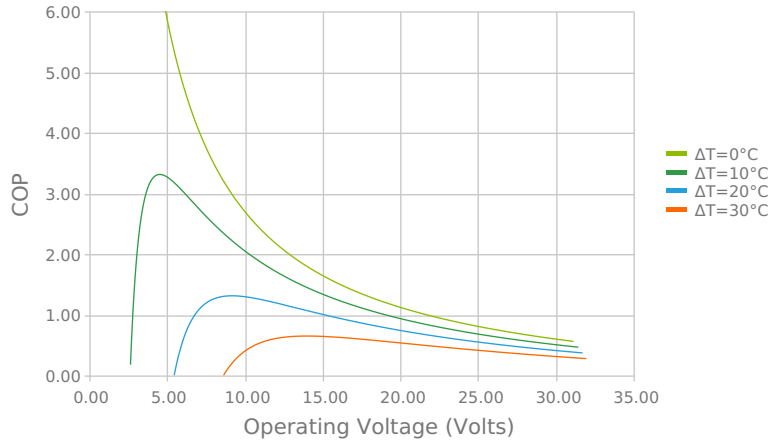

Total Heat Dissipated at Hot Side (Qh=Qc+Pin)
 Tambient = 35°C | Tcontrol = 20°C

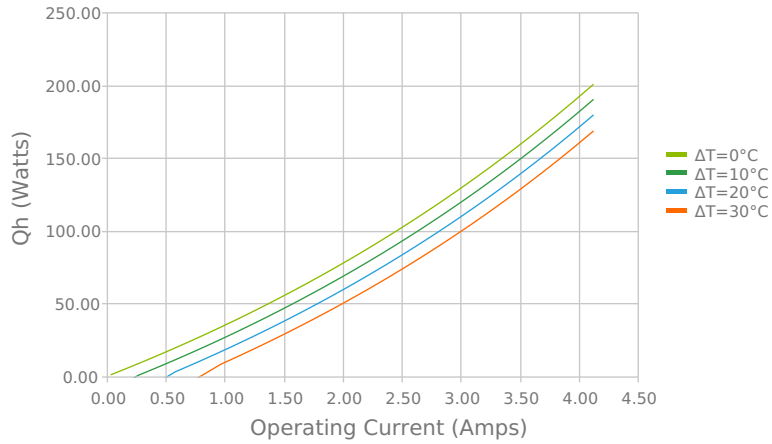

Total Heat Dissipated at Hot Side (Qh=Qc+Pin)
 Tambient = 35°C | Tcontrol = 20°C

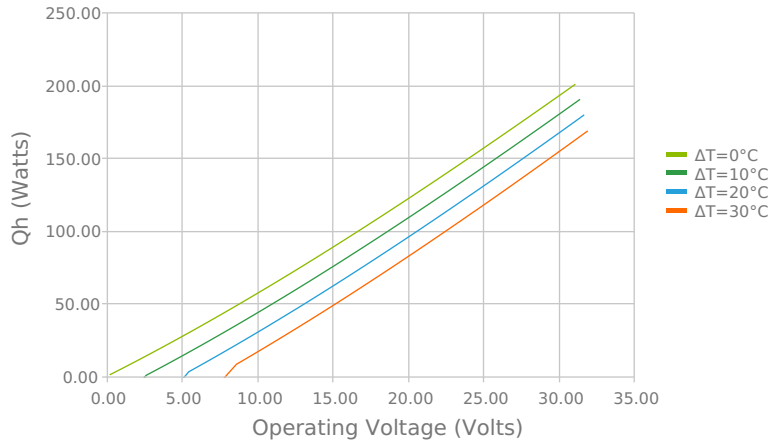

Heat Pumped at Cold Side (Qc)
 Voperating = 24 Volts | Ioperating = 3.3 Amps

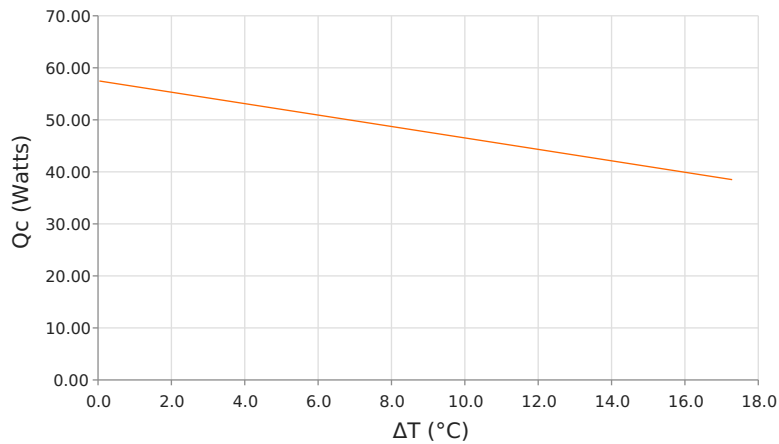

Coefficient of Performance (COP = Qc/Pin)
 Voperating = 24 Volts | Ioperating = 3.3 Amps

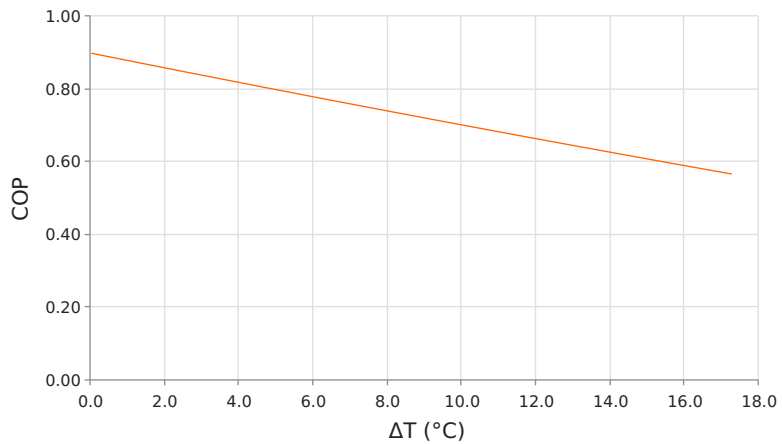

SPECIFICATIONS

Operating Temperature Range

Supply Voltage

Current Draw

Power Supply

Performance Tolerance

Fan MTBF

Weight

-10 °C to 48°C
24.0 VDC nominal / 28.0 VDC maximum
4.6 A running / 5.5 A startup
110.0 Watts
10%
50,000 hours
1.80 kg

MOUNTING HOLE LOCATION

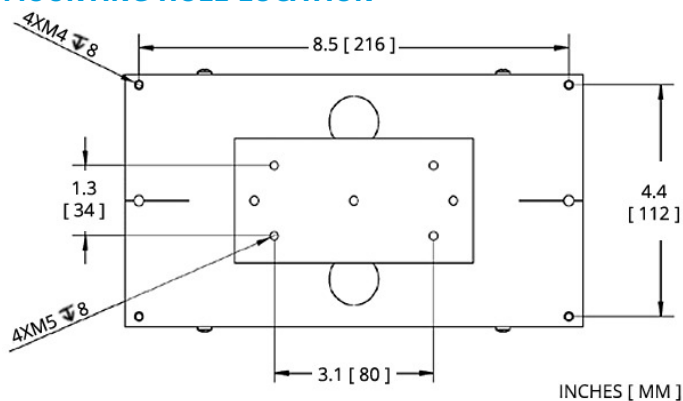

WIRING SCHEMATIC

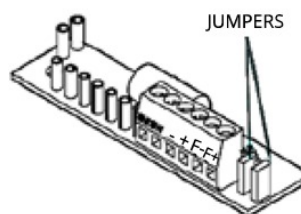

ELECTRICAL CONNECTIONS:

" + " : + TEM
 " - " : - TEM
 " F+ " : + FAN(S)
 " F- " : - FAN(S)

To use single supply:
 Lift the jumpers and rotate 90° to short-out the pin pairs.
 Connect the unit to " + " & " - ".

Warning: Single supply not applicable in heating mode or with PWM-regulation.

NOTES

¹For indoor use only

²Units are generally maintenance free, however occasionally it is recommended to clean the heat sinks and fans of debris. This is best done with compressed air.

Any information furnished by Laird and its agents, whether in specifications, data sheets, product catalogues or otherwise, is believed to be (but is not warranted as being) accurate and reliable, is provided for information only and does not form part of any contract with Laird. All specifications are subject to change without notice. Laird assumes no responsibility and disclaims all liability for losses or damages resulting from use of or reliance on this information. All Laird products are sold subject to the Laird Terms and Conditions of sale (including Laird's limited warranty) in effect from time to time, a copy of which will be furnished upon request.

© Copyright 2020 Laird Thermal Systems GmbH. All Rights Reserved. Laird, Laird Technologies, Laird Thermal Systems, the Laird Logo, and other word marks and logos are trademarks or registered trademarks of Laird Limited or an affiliate company thereof. Other product or service names may be the property of third parties. Nothing herein provides a license under any Laird or any third party intellectual property rights.

Date: 04/24/2020