

D3V

Miniature Basic Switch

Reliable Basic Switch with External Lever

- Available by 21 A, 16 A, 11 A, 6 A and 0.1 A models, all with self-cleaning contacts.
- Available with internally or externally fitted levers.

RoHS Compliant

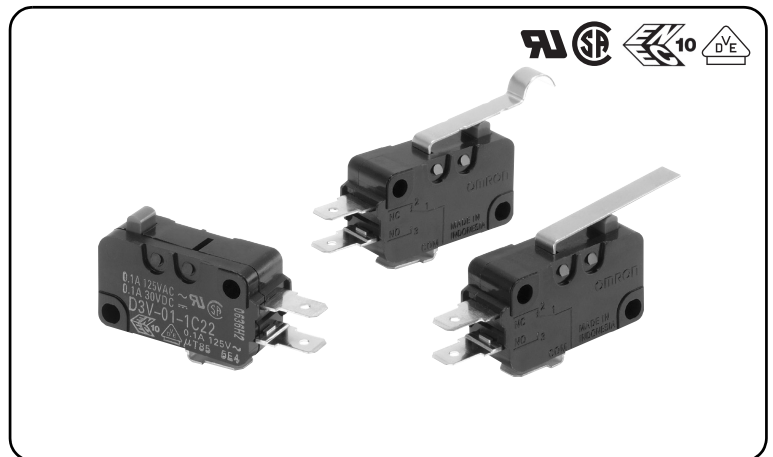

D
3
V

Model Number Legend

D3V-1 2 3 4 - 5 6 7 - 8 - 9

1. Ratings

- 21 : 20 (4) A at 250 VAC
- 16 : 16 (3) A at 250 VAC
- 11 : 11 (3) A at 250 VAC
- 6 : 16 (2) A at 250 VAC
- 01 : 0.1 A at 125 VAC

2. Contact Gap

- None : 1 mm (F gap)
- G : 0.5 mm (G gap)

3. Actuator

- None : Pin plunger
- 1 : Short hinge lever
- 2 : Hinge lever
- 3 : Long hinge lever
- 4 : Simulated roller lever
- 5 : Short hinge roller lever
- 6 : Hinge roller lever

4. Hinge Position

- None : Internal/Far from plunger

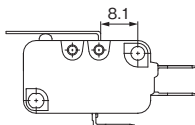

- K : External/Near plunger

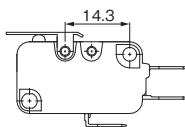

5. Contact Form

- 1 : SPDT
- 2 : SPST-NC
- 3 : SPST-NO

6. Terminals

- A : Solder terminals
- C2 : Quick-connect terminals (#187)
- C : Quick-connect terminals (#250)

7. Maximum Operating Force

- 5 : 1.96 N {200 gf}
- 4A : 1.23 N {125 gf}
- 4 : 0.98 N {100 gf}
- 3 : 0.49 N {50 gf}
- 2 : 0.25 N {25 gf}

Note. These values are for the pin plunger models.

8. Mounting Hole Size

- None : 3.1 mm
- K : 2.9 mm







9. Special Code

- None : Standard
- H : High temperature (125°C) (See note)
- E : Special rating: 21 (8) A

Note. Consult your OMRON sales representative for high temperature models.

List of Models







●21 A (OF: 1.23 N {125 gf})

Ratings	Contact gap	Actuators	Contact form	Terminals Maximum operating force (OF)	Quick-connect terminals (#250) (C)
21 A	0.5 mm (G gap)	Pin plunger 	SPDT	1.23 N {125 gf}	D3V-21G-1C4A
			SPDT-NC		-
			SPDT-NO		-
		Short hinge lever 	SPDT	1.23 N {125 gf}	D3V-21G1-1C4A
			SPDT-NC		-
			SPDT-NO		-
		Hinge lever 	SPDT	0.78 N {80 gf}	D3V-21G2-1C4A
			SPDT-NC		-
			SPDT-NO		-
		Long hinge lever 	SPDT	0.44 N {45 gf}	D3V-21G3-1C4A
			SPDT-NC		-
			SPDT-NO		-
		Simulated roller lever 	SPDT	0.83 N {85 gf}	D3V-21G4-1C4A
			SPDT-NC		-
			SPDT-NO		-
		Short hinge roller lever 	SPDT	1.42 N {145 gf}	D3V-21G5-1C4A
			SPDT-NC		-
			SPDT-NO		-
Hinge roller lever 	SPDT	0.79 N {80 gf}	D3V-21G6-1C4A		
	SPDT-NC		-		
	SPDT-NO		-		

Note. If you need mounting hole 2.9 mm, add "-K" at last of model.

Consult your OMRON sales representative when you can't find a model on this List of Models.







●16 A (OF: 1.96 N {200 gf})

Ratings	Contact gap	Actuators	Contact form	Terminals Maximum operating force (OF)	Solder terminals (A)	Quick-connect terminals (#187) (C2)	Quick-connect terminals (#250) (C)
16 A	1 mm (F gap)	Pin plunger 	SPDT	1.96 N {200 gf}	D3V-16-1A5	D3V-16-1C25	D3V-16-1C5
			SPDT-NC		D3V-16-2A5	D3V-16-2C25	D3V-16-2C5
			SPDT-NO		D3V-16-3A5	D3V-16-3C25	D3V-16-3C5
		Short hinge lever 	SPDT	1.96 N {200 gf}	D3V-161-1A5	D3V-161-1C25	D3V-161-1C5
			SPDT-NC		D3V-161-2A5	D3V-161-2C25	D3V-161-2C5
			SPDT-NO		D3V-161-3A5	D3V-161-3C25	D3V-161-3C5
		Hinge lever 	SPDT	1.23 N {125 gf}	D3V-162-1A5	D3V-162-1C25	D3V-162-1C5
			SPDT-NC		D3V-162-2A5	D3V-162-2C25	D3V-162-2C5
			SPDT-NO		D3V-162-3A5	D3V-162-3C25	D3V-162-3C5
		Long hinge lever 	SPDT	0.69 N {70 gf}	D3V-163-1A5	D3V-163-1C25	D3V-163-1C5
			SPDT-NC		D3V-163-2A5	D3V-163-2C25	D3V-163-2C5
			SPDT-NO		D3V-163-3A5	D3V-163-3C25	D3V-163-3C5
		Simulated roller lever 	SPDT	1.23 N {125 gf}	D3V-164-1A5	D3V-164-1C25	D3V-164-1C5
			SPDT-NC		D3V-164-2A5	D3V-164-2C25	D3V-164-2C5
			SPDT-NO		D3V-164-3A5	D3V-164-3C25	D3V-164-3C5
		Short hinge roller lever 	SPDT	2.35 N {240 gf}	D3V-165-1A5	D3V-165-1C25	D3V-165-1C5
			SPDT-NC		D3V-165-2A5	D3V-165-2C25	D3V-165-2C5
			SPDT-NO		D3V-165-3A5	D3V-165-3C25	D3V-165-3C5
		Hinge roller lever 	SPDT	1.23 N {125 gf}	D3V-166-1A5	D3V-166-1C25	D3V-166-1C5
			SPDT-NC		D3V-166-2A5	D3V-166-2C25	D3V-166-2C5
			SPDT-NO		D3V-166-3A5	D3V-166-3C25	D3V-166-3C5

Note. If you need mounting hole 2.9 mm, add "-K" at last of model.

Consult your OMRON sales representative when you can't find a model on this List of Models.







●11 A (OF: 1.96 N {200 gf})

Ratings	Contact gap	Actuators	Contact form	Terminals Maximum operating force (OF)	Solder terminals (A)	Quick-connect terminals (#187) (C2)	Quick-connect terminals (#250) (C)
11 A	1 mm (F gap)	Pin plunger 	SPDT	1.96N {200 gf}	D3V-11-1A5	D3V-11-1C25	D3V-11-1C5
			SPDT-NC		-	-	-
			SPDT-NO		-	-	-
		Short hinge lever 	SPDT	1.96N {200 gf}	D3V-111-1A5	D3V-111-1C25	D3V-111-1C5
			SPDT-NC		-	-	-
			SPDT-NO		-	-	-
		Hinge lever 	SPDT	1.23N {125 gf}	D3V-112-1A5	D3V-112-1C25	D3V-112-1C5
			SPDT-NC		-	-	-
			SPDT-NO		-	-	-
		Long hinge lever 	SPDT	0.69N {70 gf}	D3V-113-1A5	D3V-113-1C25	D3V-113-1C5
			SPDT-NC		-	-	-
			SPDT-NO		-	-	-
		Simulated roller lever 	SPDT	1.23N {125 gf}	D3V-114-1A5	D3V-114-1C25	D3V-114-1C5
			SPDT-NC		-	-	-
			SPDT-NO		-	-	-
		Short hinge roller lever 	SPDT	2.35N {240 gf}	D3V-115-1A5	D3V-115-1C25	D3V-115-1C5
			SPDT-NC		-	-	-
			SPDT-NO		-	-	-
		Hinge roller lever 	SPDT	1.23N {125 gf}	D3V-116-1A5	D3V-116-1C25	D3V-116-1C5
			SPDT-NC		-	-	-
			SPDT-NO		-	-	-

Note. If you need mounting hole 2.9 mm, add "-K" at last of model.

Consult your OMRON sales representative when you can't find a model on this List of Models.







●11 A (OF: 0.98 N {100 gf})

Ratings	Contact gap	Actuators	Contact form	Terminals Maximum operating force (OF)	Solder terminals (A)	Quick-connect terminals (#187) (C2)	Quick-connect terminals (#250) (C)
11 A	1 mm (F gap)	Pin plunger 	SPDT	0.98N {100 gf}	D3V-11-1A4	D3V-11-1C24	D3V-11-1C4
			SPDT-NC		-	-	-
			SPDT-NO		-	-	-
		Short hinge lever 	SPDT	0.98N {100 gf}	D3V-111-1A4	D3V-111-1C24	D3V-111-1C4
			SPDT-NC		-	-	-
			SPDT-NO		-	-	-
		Hinge lever 	SPDT	0.59N {60 gf}	D3V-112-1A4	D3V-112-1C24	D3V-112-1C4
			SPDT-NC		-	-	-
			SPDT-NO		-	-	-
		Long hinge lever 	SPDT	0.34N {35 gf}	D3V-113-1A4	D3V-113-1C24	D3V-113-1C4
			SPDT-NC		-	-	-
			SPDT-NO		-	-	-
		Simulated roller lever 	SPDT	0.59N {60 gf}	D3V-114-1A4	D3V-114-1C24	D3V-114-1C4
			SPDT-NC		-	-	-
			SPDT-NO		-	-	-
		Short hinge roller lever 	SPDT	1.18N {120 gf}	D3V-115-1A4	D3V-115-1C24	D3V-115-1C4
			SPDT-NC		-	-	-
			SPDT-NO		-	-	-
		Hinge roller lever 	SPDT	0.59N {60 gf}	D3V-116-1A4	D3V-116-1C24	D3V-116-1C4
			SPDT-NC		-	-	-
			SPDT-NO		-	-	-







Note. If you need mounting hole 2.9 mm, add "-K" at last of model.

Consult your OMRON sales representative when you can't find a model on this List of Models.

●6 A (OF: 0.98 N {100 gf})







Ratings	Contact gap	Actuators	Contact form	Terminals Maximum operating force (OF)	Solder terminals (A)	Quick-connect terminals (#187) (C2)	Quick-connect terminals (#250) (C)
6 A	1 mm (F gap)	Pin plunger 	SPDT	0.98 N {100 gf}	D3V-6-1A4	D3V-6-1C24	D3V-6-1C4
			SPDT-NC		-	-	-
			SPDT-NO		-	-	-
		Short hinge lever 	SPDT	0.98 N {100 gf}	D3V-61-1A4	D3V-61-1C24	D3V-61-1C4
			SPDT-NC		-	-	-
			SPDT-NO		-	-	-
		Hinge lever 	SPDT	0.59 N {60 gf}	D3V-62-1A4	D3V-62-1C24	D3V-62-1C4
			SPDT-NC		-	-	-
			SPDT-NO		-	-	-
		Long hinge lever 	SPDT	0.34 N {35 gf}	D3V-63-1A4	D3V-63-1C24	D3V-63-1C4
			SPDT-NC		-	-	-
			SPDT-NO		-	-	-
		Simulated roller lever 	SPDT	0.59 N {60 gf}	D3V-64-1A4	D3V-64-1C24	D3V-64-1C4
			SPDT-NC		-	-	-
			SPDT-NO		-	-	-
		Short hinge roller lever 	SPDT	1.18 N {120 gf}	D3V-65-1A4	D3V-65-1C24	D3V-65-1C4
			SPDT-NC		-	-	-
			SPDT-NO		-	-	-
		Hinge roller lever 	SPDT	0.59 N {60 gf}	D3V-66-1A4	D3V-66-1C24	D3V-66-1C4
			SPDT-NC		-	-	-
			SPDT-NO		-	-	-

●6 A (OF: 0.49 N {50 gf})

Ratings	Contact gap	Actuators	Contact form	Terminals Maximum operating force (OF)	Solder terminals (A)	Quick-connect terminals (#187) (C2)	Quick-connect terminals (#250) (C)
6 A	0.5 mm Ggap)	Pin plunger 	SPDT	0.49 N {50 gf}	D3V-6G-1A3	D3V-6G-1C23	D3V-6G-1C3
			SPDT-NC		-	-	-
			SPDT-NO		-	-	-
		Short hinge lever 	SPDT	0.49 N {50 gf}	D3V-6G1-1A3	D3V-6G1-1C23	D3V-6G1-1C3
			SPDT-NC		-	-	-
			SPDT-NO		-	-	-
		Hinge lever 	SPDT	0.59 N {60 gf}	D3V-6G2-1A3	D3V-6G2-1C23	D3V-6G2-1C3
			SPDT-NC		-	-	-
			SPDT-NO		-	-	-
		Long hinge lever 	SPDT	0.20 N {20 gf}	D3V-6G3-1A3	D3V-6G3-1C23	D3V-6G3-1C3
			SPDT-NC		-	-	-
			SPDT-NO		-	-	-
		Simulated roller lever 	SPDT	0.29 N {30 gf}	D3V-6G4-1A3	D3V-6G4-1C23	D3V-6G4-1C3
			SPDT-NC		-	-	-
			SPDT-NO		-	-	-
		Short hinge roller lever 	SPDT	0.59 N {60 gf}	D3V-6G5-1A3	D3V-6G5-1C23	D3V-6G5-1C3
			SPDT-NC		-	-	-
			SPDT-NO		-	-	-
		Hinge roller lever 	SPDT	0.29 N {30 gf}	D3V-6G6-1A3	D3V-6G6-1C23	D3V-6G6-1C3
			SPDT-NC		-	-	-
			SPDT-NO		-	-	-

Note. If you need mounting hole 2.9 mm, add "-K" at last of model.
Consult your OMRON sales representative when you can't find a model on this List of Models.

●0.1 A (OF: 0.49 N {50 gf})

Ratings	Contact gap	Actuators	Contact form	Terminals Maximum operating force (OF)	Solder terminals (A)	Quick-connect terminals (#187) (C2)	Quick-connect terminals (#250) (C)
0.1 A	1 mm (F gap)	 Pin plunger	SPDT	0.49 N {50 gf}	D3V-01-1A3	D3V-01-1C23	D3V-01-1C3
			SPDT-NC		D3V-01-2A3	D3V-01-2C23	D3V-01-2C3
			SPDT-NO		D3V-01-3A3	D3V-01-3C23	D3V-01-3C3
		 Short hinge lever	SPDT	0.49 N {50 gf}	D3V-011-1A3	D3V-011-1C23	D3V-011-1C3
			SPDT-NC		D3V-011-2A3	D3V-011-2C23	D3V-011-2C3
			SPDT-NO		D3V-011-3A3	D3V-011-3C23	D3V-011-3C3
		 Hinge lever	SPDT	0.59 N {60 gf}	D3V-012-1A3	D3V-012-1C23	D3V-012-1C3
			SPDT-NC		D3V-012-2A3	D3V-012-2C23	D3V-012-2C3
			SPDT-NO		D3V-012-3A3	D3V-012-3C23	D3V-012-3C3
		 Long hinge lever	SPDT	0.20 N {20 gf}	D3V-013-1A3	D3V-013-1C23	D3V-013-1C3
			SPDT-NC		D3V-013-2A3	D3V-013-2C23	D3V-013-2C3
			SPDT-NO		D3V-013-3A3	D3V-013-3C23	D3V-013-3C3
		 Simulated roller lever	SPDT	0.29 N {30 gf}	D3V-014-1A3	D3V-014-1C23	D3V-014-1C3
			SPDT-NC		D3V-014-2A3	D3V-014-2C23	D3V-014-2C3
			SPDT-NO		D3V-014-3A3	D3V-014-3C23	D3V-014-3C3
		 Short hinge roller lever	SPDT	0.59 N {60 gf}	D3V-015-1A3	D3V-015-1C23	D3V-015-1C3
			SPDT-NC		D3V-015-2A3	D3V-015-2C23	D3V-015-2C3
			SPDT-NO		D3V-015-3A3	D3V-015-3C23	D3V-015-3C3
		 Hinge roller lever	SPDT	0.29 N {30 gf}	D3V-016-1A3	D3V-016-1C23	D3V-016-1C3
			SPDT-NC		D3V-016-2A3	D3V-016-2C23	D3V-016-2C3
			SPDT-NO		D3V-016-3A3	D3V-016-3C23	D3V-016-3C3

Note. If you need mounting hole 2.9 mm, add "-K" at last of model.

Consult your OMRON sales representative when you can't find a model on this List of Models.

Contact Form

●SPDT

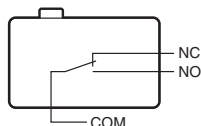

●SPST-NC

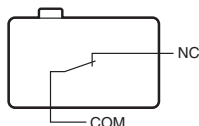

●SPST-NO

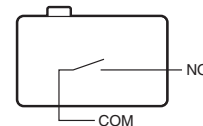

Contact Specifications

Item	Model	D3V-21	D3V-16	D3V-11	D3V-6	D3V-01
Contact	Specification	Rivet				Crossbar
	Material	Silver alloy				Gold alloy
	Gap (standard value)	0.5 mm	1.0 mm (F gap) or 0.5 mm (G gap)			1.0 mm
Inrush current	NC	50 A max.	40 A max.	24 A max.	15 A max.	---
	NO					
Minimum applicable load (see note)		160 mA at 5 VDC				1 mA at 5 VDC

Note. For more information on the minimum applicable load, refer to *Using Micro Loads* on page 11.

D
3
V

Ratings

Model	Rated voltage	Item	Resistive load
D3V-21	250 VAC		21 A
	125 VDC		0.6 A
	250 VDC		0.3 A
D3V-16	250 VAC		16 A
	125 VDC		0.6 A
	250 VDC		0.3 A
D3V-11	250 VAC		11 A
	125 VDC		0.6 A
	250 VDC		0.3 A
D3V-6	250 VAC		6 A
	125 VDC		0.4 A
	250 VDC		0.3 A
D3V-01	125 VAC		0.1 A
	30 VDC		0.1 A

Note 1. The above current values are the normal current values of models with a contact gap of 1 mm (gap F), which vary with the normal current values of models with a contact gap of 0.5 mm (gap G).

Note 2. The ratings values apply under the following test conditions:

Ambient temperature: 20±2°C

Ambient humidity: 65±5%

Operating frequency: 30 operations/min

Approved Safety Standards

Consult your OMRON sales representative for specific models with standard approvals.

UL1054 (File No. E41515)/CSA C22.2 No.55 (File No. LR21642)

Rated voltage	Model	D3V-21G	D3V-16	D3V-16G	D3V-11	D3V-11G	D3V-6	D3V-6G	D3V-01
125 VAC		---	16 A, 1/2 HP	16 A, 1/2 HP	11 A, 1/2 HP	11 A, 1/2 HP	6 A, 1/4 HP	6 A, 1/4 HP	0.1 A
250 VAC		20.1 A	16 A, 1/2 HP	16 A, 1/2 HP	11 A, 1/2 HP	11 A, 1/2 HP	6 A, 1/4 HP	6 A, 1/4 HP	---
125 VDC		---	0.6 A	0.1 A	0.6 A	0.1 A	---	---	---
250 VDC		---	0.3 A	---	0.3 A	---	---	---	---

EN 61058-1: 1992+A1: 1993 (License No. 40024894)

Rated voltage	Model	D3V-21G	D3V-16	D3V-11	D3V-6	D3V-01
125 VAC		---	---	---	---	0.1 A
250 VAC		20 (4) A	16 (3) A	11 (3) A	6 (2) A	---

Testing conditions: 5E4 (50,000 operations), T85 (0 to 85°C) for D3V-21/D3V-01, T105 (0 to 105°C) for D3V-16/D3V-11/D3V-6

Rated voltage	Model	D3V-21G
250 VAC		21 (8) A

Testing conditions: 10,000 operations, T85 (0 to 85°C)

Characteristics

Item	Model	D3V-21	D3V-16	D3V-11	D3V-6	D3V-01
Permissible operating speed		0.1 mm to 1 m/s (pin plunger models)				
Permissible operating frequency		Mechanical: 600 operations/min max. Electrical: 30 operations/min max.				
Insulation resistance		100 MΩ min. (at 500 VDC with insulation tester)				
Contact resistance (initial values)		50 mΩ max.	30 mΩ max.			0.49N {50 gf}: 50 mΩ max. 0.25N {25 gf}: 100 mΩ max.
Dielectric strength (see note 2)		1,000 VAC, 50/60 Hz for 1 min between terminals of the same polarity				
		2,000 VAC, 50/60 Hz for 1 min between current-carrying metal parts and ground, and between each terminal and non-current-carrying metal parts				
Vibration resistance (see note 3)		Malfunction: 10 to 55 Hz, 1.5-mm double amplitude				
Shock resistance (see note 3)		Destruction: 400 m/s ² {approx. 40 G} max. Malfunction: 100 m/s ² {approx. 10 G} max.				
Durability (see note 4)	Mechanical	10,000,000 operations min.				
	Electrical	50,000 operations min.	100,000 operations min.	200,000 operations min.	500,000 operations min.	
Degree of protection		IEC IP40				
Degree of protection against electric shock		Class I				
Proof tracking index (PTI)		250				
Ambient operating temperature		-25 to +85°C (at ambient humidity of 60% max.) (with no icing or condensation)	-25 to +105°C (at ambient humidity of 60% max.) (with no icing or condensation)			-25 to +85°C (at ambient humidity of 60% max.) (with no icing or condensation)
Ambient operating humidity		85% max. (for +5 to +35°C)				
Weight		Approx. 6.2 g (pin plunger models)				

Note 1. The data given above are initial values.

Note 2. The dielectric strength values shown in the table are for models with a Separator.

Note 3. For the pin plunger models, the above values apply for use at both the free position and total travel position. For the lever models, they apply at the total travel position.

Note 4. For testing conditions, contact your OMRON sales representative.

Terminals/Apearances (Unit: mm)

Solder Terminals (A)	Quick-connect Terminals (#187) (C2)	Quick-connect Terminals (#250) (C)
<p>t = 0.5 Three, solder terminals</p>	<p>t = 0.5 Three, quick-connect terminals (#187)</p>	<p>t = 0.8 Three, quick-connect terminals (#250)</p>
<p>Note: Indicates the length to the center of the 1.6-dia. holes</p>	<p>1.6-dia. terminal hole</p>	<p>1.65-dia. terminal hole</p>

Note. The table below is for the SPDT contact specifications. Two terminals will be available for SPST-NO or SPST-NC contact specifications. For terminal positions, refer to Contact Form on page 5.

Mounting Holes (Unit: mm)

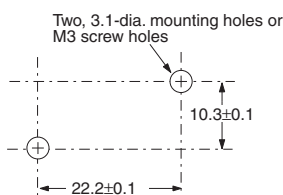

●Long Hinge Lever Models

D3V-21G3-1C4A

D3V-163-1□5

D3V-113-1□5

D3V-113-1□4

D3V-63-1□4

D3V-6G3-1□3

D3V-013-1□3

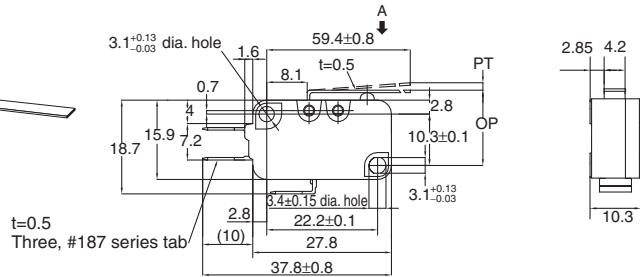
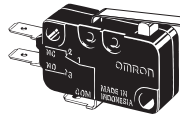

Operating Characteristics		Model	D3V-21G3-1C4A	D3V-163-1□5 D3V-113-1□5	D3V-113-1□4 D3V-63-1□4	D3V-6G3-1□3	D3V-013-1□3
Operating Force	OF	Max.	0.44 N {45 gf}	0.69 N {70 gf}	0.34 N {35 gf}	0.20 N {20 gf}	
	RF	Min.	0.03 N {3 gf}	0.06 N {6 gf}	---	---	
Pretravel	PT	Max.	9.0 mm	9.0 mm	9.0 mm	9.0 mm	9.0 mm
	OT	Min.	2.0 mm	2.0 mm	2.0 mm	3.2 mm	3.2 mm
Movement Differential	MD	Max.	2.0 mm	2.8 mm	2.0 mm	2.0 mm	2.8 mm
		Operating Position	OP	15.2 ^{+2.6} _{-3.2} mm		15.2±2.6 mm	

●Simulated Roller Lever Models

D3V-21G4-1C4A

D3V-164-1□5

D3V-114-1□5

D3V-114-1□4

D3V-64-1□4

D3V-6G4-1□3

D3V-014-1□3

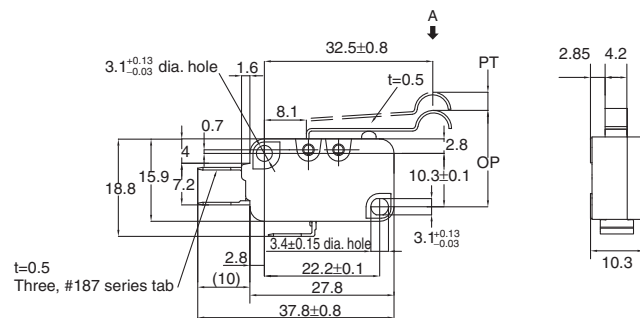
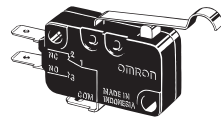

Operating Characteristics		Model	D3V-21G4-1C4A	D3V-164-1□5 D3V-114-1□5	D3V-114-1□4 D3V-64-1□4	D3V-6G4-1□3	D3V-014-1□3
Operating Force	OF	Max.	0.83 N {85 gf}	1.23 N {125 gf}	0.59 N {60 gf}	0.29 N {30 gf}	
	RF	Min.	0.07 N {7 gf}	0.14 N {14 gf}	0.06 N {6 gf}	---	
Pretravel	PT	Max.	4.0 mm	4.0 mm	4.0 mm	4.0 mm	4.0 mm
	OT	Min.	1.6 mm	1.6 mm	1.6 mm	1.6 mm	1.6 mm
Movement Differential	MD	Max.	1.4 mm	1.5 mm	1.5 mm	1.4 mm	1.5 mm
		Operating Position	OP	18.7±1.2 mm			

●Short Hinge Roller Lever Models

D3V-21G5-1C4A

D3V-165-1□5

D3V-115-1□5

D3V-115-1□4

D3V-65-1□4

D3V-6G5-1□3

D3V-015-1□3

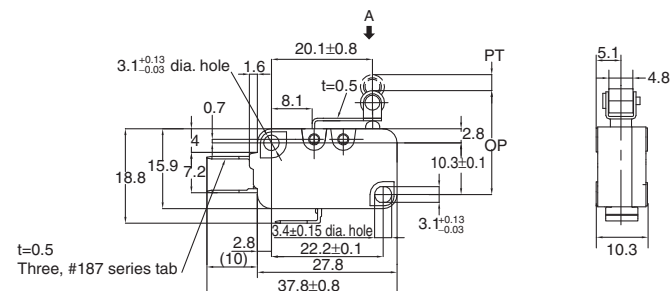
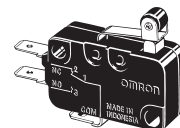

Operating Characteristics		Model	D3V-21G5-1C4A	D3V-165-1□5 D3V-115-1□5	D3V-115-1□4 D3V-65-1□4	D3V-6G5-1□3	D3V-015-1□3
Operating Force	OF	Max.	1.42 N {145 gf}	2.35 N {240 gf}	1.18 N {120 gf}	0.59 N {60 gf}	
	RF	Min.	0.2 N {20 gf}	0.49 N {50 gf}	0.15 N {15 gf}	0.06 N {6 gf}	
Pretravel	PT	Max.	1.6 mm	1.6 mm	1.6 mm	1.6 mm	1.6 mm
	OT	Min.	0.8 mm	0.8 mm	0.8 mm	0.8 mm	0.8 mm
Movement Differential	MD	Max.	0.5 mm	0.6 mm	0.6 mm	0.5 mm	0.6 mm
		Operating Position	OP	20.7±0.6 mm			

Note 1. Unless otherwise specified, a tolerance of ±0.4 mm applies to all dimensions.

Note 2. The operating characteristics are for operation in the A direction (↓).

●Hinge Roller Lever Models

D3V-21G6-1C4A

D3V-166-1□5

D3V-116-1□5

D3V-116-1□4

D3V-66-1□4

D3V-6G6-1□3

D3V-016-1□3

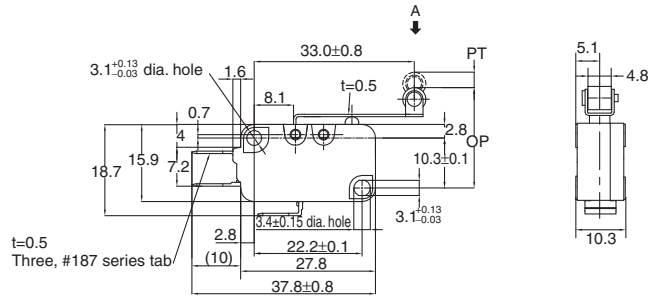
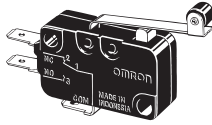

D
3
V

Operating Characteristics			Model	D3V-21G6-1C4A	D3V-166-1□5 D3V-116-1□5	D3V-116-1□4 D3V-66-1□4	D3V-6G6-1□3	D3V-016-1□3
Operating Force	OF	Max.		0.79 N {80 gf}	1.23 N {125 gf}	0.59 N {60 gf}	0.29 N {30 gf}	
Releasing Force	RF	Min.		0.05 N {5 gf}	0.14 N {14 gf}	0.06 N {6 gf}	---	
Pretravel	PT	Max.		4.0 mm	4.0 mm		4.0 mm	4.0 mm
Overtravel	OT	Min.		1.6 mm	1.6 mm		1.6 mm	1.6 mm
Movement Differential	MD	Max.		0.8 mm	1.5 mm		0.8 mm	1.5 mm
Operating Position	OP			20.7±1.2 mm				

Note 1. Unless otherwise specified, a tolerance of ±0.4 mm applies to all dimensions.

Note 2. The operating characteristics are for operation in the A direction (↓).

Precautions

★Please refer to "Common Precautions" for correct use.

Cautions

●Handling

Be careful not to drop the switch. Doing so may cause damage to the switch's internal components because it is designed for a small load.

Correct Use

●Mounting

Use two M3 mounting screws with an appropriate screwdriver to mount the switch. Tighten the screws to a torque of 0.39 to 0.59 N·m {4 to 6 kgf·cm}.

●Mounting Direction

Mount lever-operated switches with a maximum operating force of 0.49 N in a direction where the actuator weight will not be applied to the switch. Since the switch is designed for a small load, its resetting force is small. Therefore, resetting failure may occur if unnecessary load is applied to the switch.

●Insulation Distance

According to EN61058-1, the minimum insulation thickness for this switch should be 1.1 mm and minimum clearance distance between the terminal and mounting plate should be 1.9 mm. If the insulation distance cannot be provided in the product incorporating the switch, either use a switch with insulation barrier or use a Separator to ensure sufficient insulation distance.

●Using Micro Loads

Using a model for ordinary loads to open or close the contact of a micro load circuit may result faulty contact. Use models that operate in the following range. However, even when using micro load models within the operating range shown below, if inrush current occurs when the contact is opened or closed, it may increase contact wear and so decrease durability. Therefore, insert a contact protection circuit where necessary. The minimum applicable load is the N-level reference value. This value indicates the malfunction reference level for the reliability level of 60% (λ_{60}). The equation, $\lambda_{60} = 0.5 \times 10^{-6}/\text{operations}$ indicates that the estimated malfunction rate is less than 1/2,000,000 operations with a reliability level of 60%.

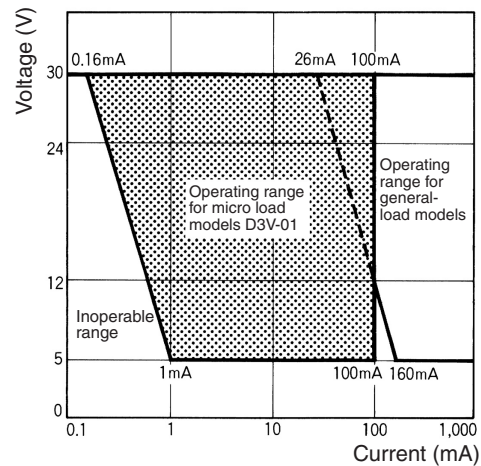

●Solder Terminal Approval Conditions

Soldering iron can be used. Soldering hook hole available.
Soldering terminal types 1 and 2 are met.

Actuator (Sold Separately)

Various Actuators are available as shown on D3V/V/VX/D2MV/D2RV Common Accessories.

Connector (Sold Separately)

Refer to Terminal Connectors.

• Application examples provided in this document are for reference only. In actual applications, confirm equipment functions and safety before using the product.
• Consult your OMRON representative before using the product under conditions which are not described in the manual or applying the product to nuclear control systems, railroad systems, aviation systems, vehicles, combustion systems, medical equipment, amusement machines, safety equipment, and other systems or equipment that may have a serious influence on lives and property if used improperly. Make sure that the ratings and performance characteristics of the product provide a margin of safety for the system or equipment, and be sure to provide the system or equipment with double safety mechanisms.

Note: Do not use this document to operate the Unit.

Mouser Electronics

Authorized Distributor

Click to View Pricing, Inventory, Delivery & Lifecycle Information:

Omron:

[D3V-16G2M1C25K](#) [D3V-11G2M1C25K](#) [D3V-11G4M1C25K](#) [D3V-16G4M1C25K](#) [D3V-16G21C25K](#) [D3V-11G21C25K](#) [D3V-11G1C25K](#) [D3V-11G6M1C25K](#) [D3V-16G6M1C25K](#) [D3V-11G61C25K](#) [D3V-16G61C25K](#) [D3V-16G41C25K](#) [D3V-11G41C25K](#) [D3V-16G2-3C25-K](#) [D3V-21G-1C4A-K](#) [D3V-11-2A5](#) [D3V-16G-1C25](#) [D3V-11-2C25](#) [D3V-16G-3C25](#) [D3V-16-1C5](#) [D3V-16G-1C5](#) [D3V-16G-3C5](#) [D3V-21G-1C4A](#) [D3V-11-1A4](#) [D3V-6-1C24](#) [D3V-11G-1C4](#) [D3V-01-1C23](#) [D3V-11G-1C23](#) [D3V-11G-1C3](#) [D3V-01-1C22](#) [D3V-01-3C22](#) [D3V-16-1A5-K](#) [D3V-11-1A5-K](#) [D3V-16G-1A5-K](#) [D3V-11G-1A5-K](#) [D3V-11-2A5-K](#) [D3V-16G-2A5-K](#) [D3V-11G-2A5-K](#) [D3V-16G-3A5-K](#) [D3V-11G-3A5-K](#) [D3V-16-1C25-K](#) [D3V-16G-2C25-K](#) [D3V-11G-2C25-K](#) [D3V-16G-3C25-K](#) [D3V-11G-3C25-K](#) [D3V-11G-1C5-K](#) [D3V-16G-2C5-K](#) [D3V-16G-3C5-K](#) [D3V-16G-1C4A-K](#) [D3V-21G-2C4A-K](#) [D3V-21G-3C4A-K](#) [D3V-6-1A4-K](#) [D3V-01-1A4-K](#) [D3V-11G-1A4-K](#) [D3V-6G-1A4-K](#) [D3V-11G-2A4-K](#) [D3V-6G-2A4-K](#) [D3V-11G-3A4-K](#) [D3V-6G-3A4-K](#) [D3V-16-1C24-K](#) [D3V-11-1C24-K](#) [D3V-6-1C24-K](#) [D3V-16G-1C24-K](#) [D3V-11G-1C24-K](#) [D3V-6G-1C24-K](#) [D3V-11G-2C24-K](#) [D3V-6G-2C24-K](#) [D3V-11-3C24-K](#) [D3V-11G-3C24-K](#) [D3V-6G-3C24-K](#) [D3V-11G-1C4-K](#) [D3V-6G-1C4-K](#) [D3V-11G-2C4-K](#) [D3V-6-3C4-K](#) [D3V-16G-3C4-K](#) [D3V-6G-3C4-K](#) [D3V-01-1A3-K](#) [D3V-01-1C23-K](#) [D3V-11G-1C23-K](#) [D3V-6G-1C23-K](#) [D3V-6G-2C23-K](#) [D3V-01-3C23-K](#) [D3V-6G-1C3-K](#) [D3V-01G-2C3-K](#) [D3V-6G-3C3-K](#) [D3V-01-1C22-K](#) [D3V-16G-1C25-K-H](#) [D3V-16-1C5-K-H](#) [D3V-11G-1C24-K-H](#) [D3V-01-3C23-T](#) [D3V-112-1C24](#) [D3V-114-1C4](#) [D3V-11G1-1C24-K](#) [D3V-11G1-1C25-K](#) [D3V-11G1M-1A4-K](#) [D3V-11G1M-1A5-K](#) [D3V-11G1M-1C24-K](#) [D3V-11G1M-1C25-K](#) [D3V-11G1M-2A4-K](#) [D3V-11G1M-2A5-K](#)