



Part No: CX-1606C

Description: magnetic buzzer

Date: 1/30/2006

Unit: mm

Page No: 1 of 4

### SCOPE

This specification applies to magnetic buzzer, CX-1606C

### SPECIFICATION

No.	Item	Unit	Specification	Condition
1	Rated Voltage	V <sub>DC</sub>	6.0	
2	Operating Volt.	V <sub>DC</sub>	4.0~7.0	
3	Mean Current	mA	Max. 50	
4	Sound Output	dBA	Min.85 (Typical 92)	Distance at 10cm(A-weight free air).
5	Resonant Frequency	Hz	2200 ± 300	
6	Operating Temp.	°C	-20 ~ +60	
7	Storage Temp.	°C	-30 ~ +70	
8	Dimension	mm	φ 16.0 × H14.0	See attached drawing.
9	Weight	gram	7.0	
10	Material		PPO (Black)	
11	Terminal		Pin type (Plating Au)	See attached drawing.
12	Environmental Protection Regulation		RoHS	

### TYPICAL FREQUENCY RESPONSE CURVE

VOLTAGE-SOUND PRESSURE LEVEL

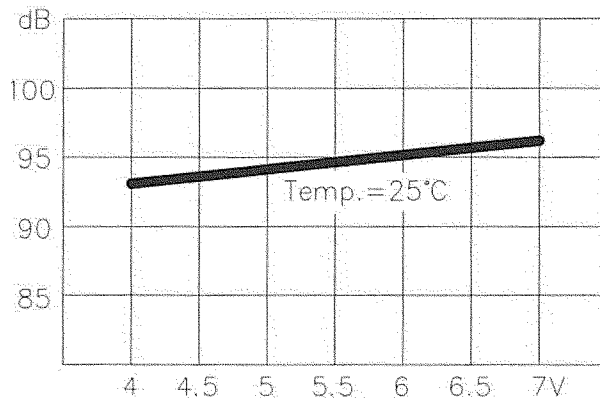

VOLTAGE-CURRENT CONSUMPTION

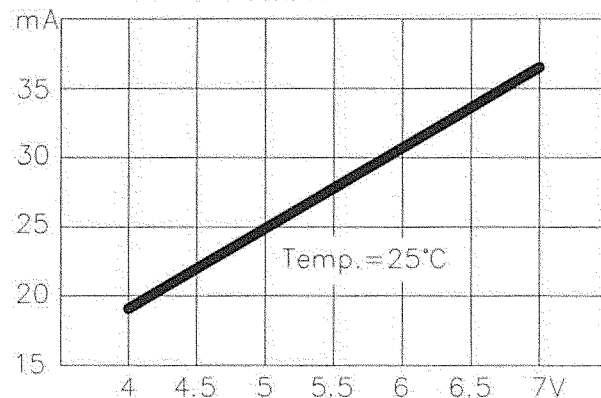

### APPEARANCE DRAWING

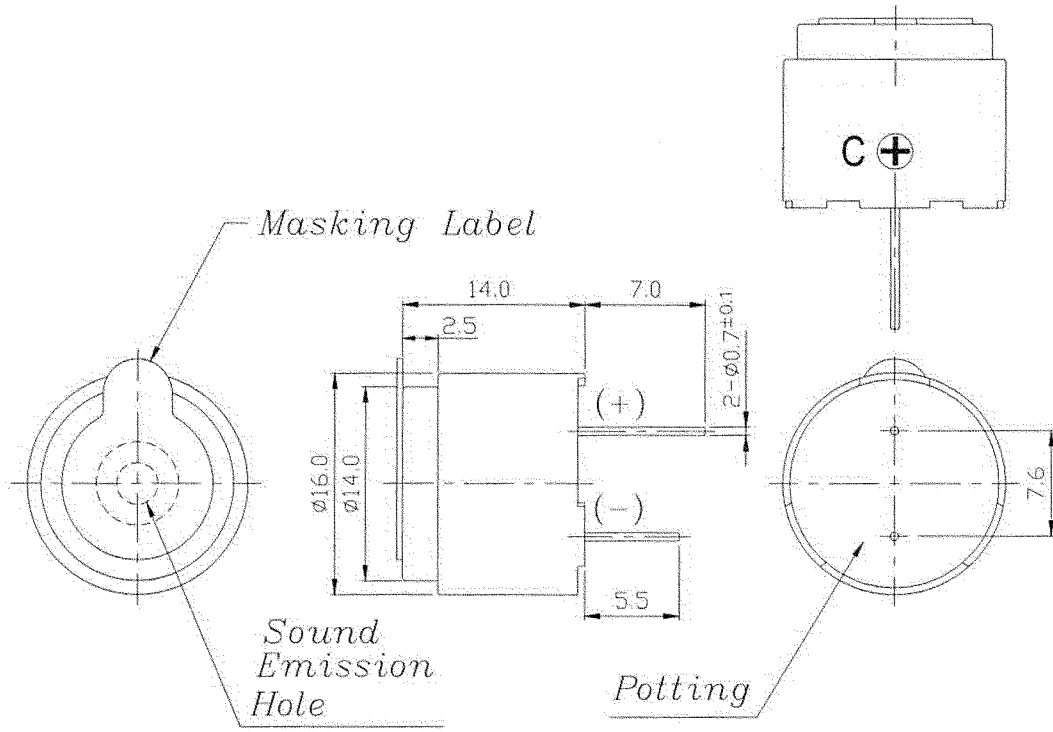

**Tol:  $\pm 0.5$**   
**Unit: mm**

### MEASUREMENT METHOD

+V DC

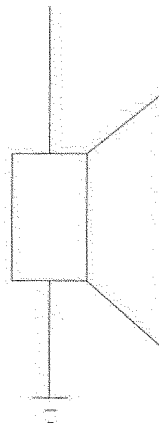



Part No: CX-1606C

Description: magnetic buzzer

Date: 1/30/2006

Unit: mm

Page No: 3 of 4

### MECHANICAL CHARACTERISTICS

No.	Item	Test condition	Evaluation standard
1	Solderability <sup>1</sup>	Lead terminals are immersed in rosin for 5 seconds and then immersed in solder bath of +270±5°C for 3±1 seconds.	90% min. lead terminals shall be wet with solder. (Except the edge of terminal)
2	Soldering Heat Resistance	Lead terminal are immersed up to 1.5mm from sounder's body in solder bath of +260±5°C for 3±1 seconds.	No interference in operation
3	Terminal Mechanical Strength	The force 10 seconds of 9.8N (1.0kg) is applied to each terminal in axial direction.	No damage and cutting off
4	Vibration	Buzzer shall be measured after being applied vibration of amplitude of 1.5mm with 10 to 55hz band of vibration frequency to each of 3 per-pendicular directions for 2 hours.	After the test the part shall meet specifications with-out any damage in appearance and the SPL should be in ±10dBA compared with initial one.
5	Drop test	The part only shall be dropped from a height of 75cm onto a 40mm thick wooden board 3 times in 3 axes (X.Y.Z). (a total of 9 times).	

Notes: 1. Not recommended for wave soldering

### ENVIRONMENT TEST

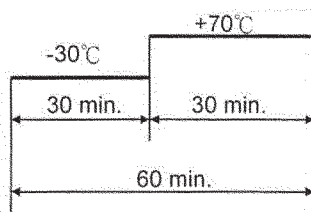
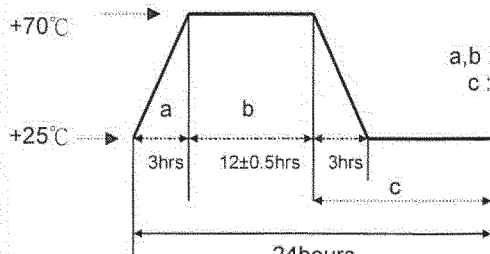
No.	Item	Test condition	Evaluation standard
1	High temp. test	After being placed in a chamber at +70°C for 96 hours.	After the test the part shall meet specifications with-out any degradation in appearance and performance except SPL. after 4 hours at +25°C. the SPL should be in ±10dBA compared with initial one.
2	Low temp. test	After being placed in a chamber at -30°C for 96 hours.	
3	Thermal Shock	The part shall be subjected to 10 cycles. One cycle shall consist of: 	
4	Temp./ Humidity Cycle	The part shall be subjected to 10 cycles. One cycle shall be 24 hours and consist of:  a, b : 90~98%RH c : 80~98%RH	

### RELIABILITY TEST

No.	Item	Test condition	Evaluation standard
1	Operating life test	1. Continuous life test The part shall be subjected to 72 hours at +45°C with 6VDC applied.  2. Intermittent life test A duty cycle of 1 minute on, 1 minutes off, a minimum of 10000 times at room temp.( +25±10°C) with 6VDC applied.	After the test the part shall meet specifications with-out any degradation in appearance and performance except SPL. after 4 hours at +25°C. the SPL should be in ±10dBA compared with initial one.

#### TEST CONDITION.

Standard Test Condition : a) Temperature : +5 ~ +35°C b) Humidity : 45-85% c) Pressure : 860-1060mbar

Judgement Test Condition : a) Temperature : +25 ± 2°C b) Humidity : 60-70% c) Pressure : 860-1060mbar

### PACKING STANDARD

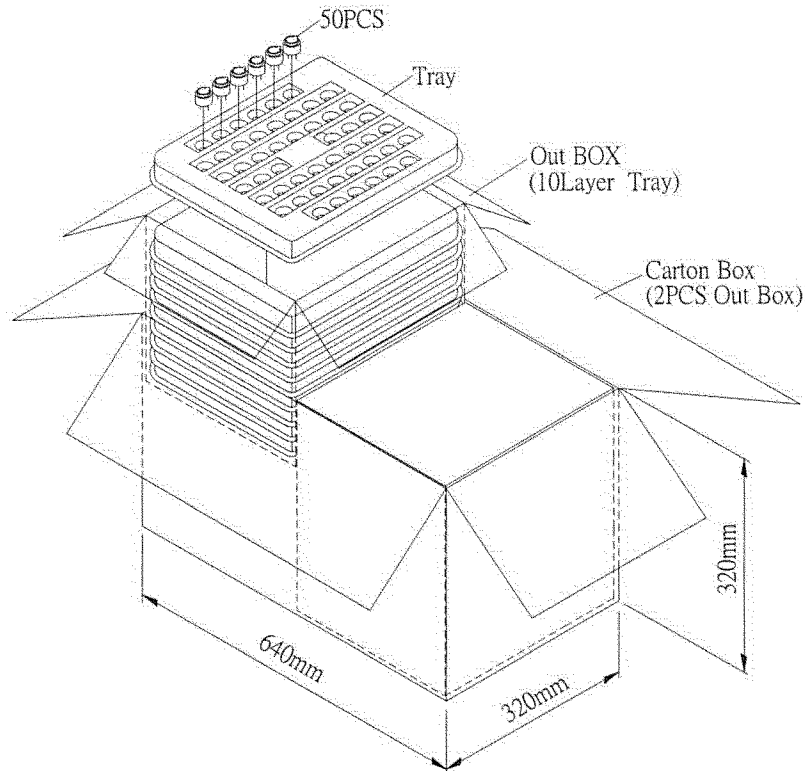

Tray	280mmx280mmx22mm	1x50PCS=50PCS
Out Box	310mmx310mmx310mm	10LAYERx50PCS=500PCS
Carton Box	640mmx320mmx320mm	500PCSx2=1000PCS