

Ultra Fast Recovery Diodes

$V_{RM}: 70 \sim 400V$

$I_o: 5.0 \sim 20A$

CTG

Rating/ Characteristics	Absolute Maximum Ratings						Electrical Characteristics (Ta = 25°C)					Others		
	V <sub>RSM</sub> (V)	V <sub>RM</sub> (V)	I <sub>o</sub> (A)	I <sub>FSM</sub> (A)	T <sub>j</sub> (°C)	T <sub>stg</sub> (°C)	V <sub>F</sub> (V)	I <sub>R</sub> (mA)	I <sub>R(H)</sub> (mA)	trr (μs)	I <sub>F</sub> /I <sub>RP</sub> (mA)	Outline Drawing	Weight(g)	Taping
Type No.	per chip		With Fin	50Hz Half-Sine Wave Single Pulse			Max. per chip	I <sub>F</sub> (A)	V <sub>R</sub> = V <sub>RM</sub> max (per chip)	V <sub>R</sub> = V <sub>RM</sub> , T <sub>j</sub> = 140°C max (per chip)				
CTG-11S	70	70	5.0	35	-40 ~ +140		1.3	2.5	1.5	0.1	100/100	Ⓢ66	2.6	For High Frequency Rectification
CTG-11R	70	70												
CTG-12S	200	200												
CTG-12R	200	200												
CTG-14S	400	400												
CTG-14R	400	400												
CTG-21S	70	70	10	65										
CTG-21R	70	70												
CTG-22S	200	200												
CTG-22R	200	200												
CTG-23S	300	300												
CTG-23R	300	300												
CTG-24S	400	400	8.0											
CTG-24R	400	400												
CTG-31S	70	70	20	150										
CTG-31R	70	70												
CTG-32S	200	200												
CTG-32R	200	200												
CTG-33S	300	300												
CTG-33R	300	300												
CTG-34S	400	400	16	100										
CTG-34R	400	400												

Thermal Resistance R<sub>th(j-c)</sub>: 3.0°C/W (CTG-11S~24R)  
1.5°C/W (CTG-31S~34R)

Outline Drawing Ⓢ66

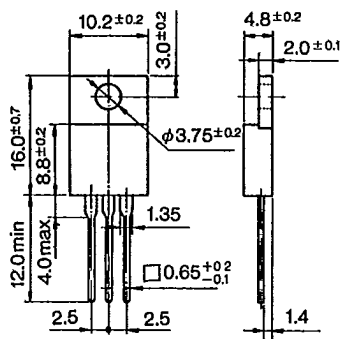

Outline Drawing Ⓢ67

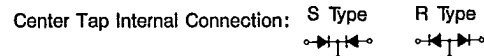
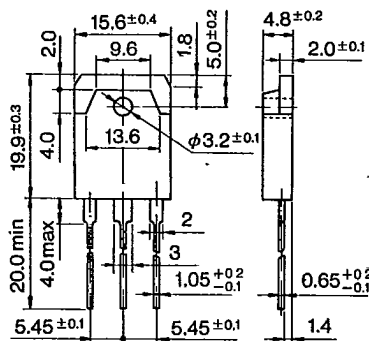

Ⓢ66 Ⓢ67 Plastic Molded, Flammability : UL94V-0 or Equivalent

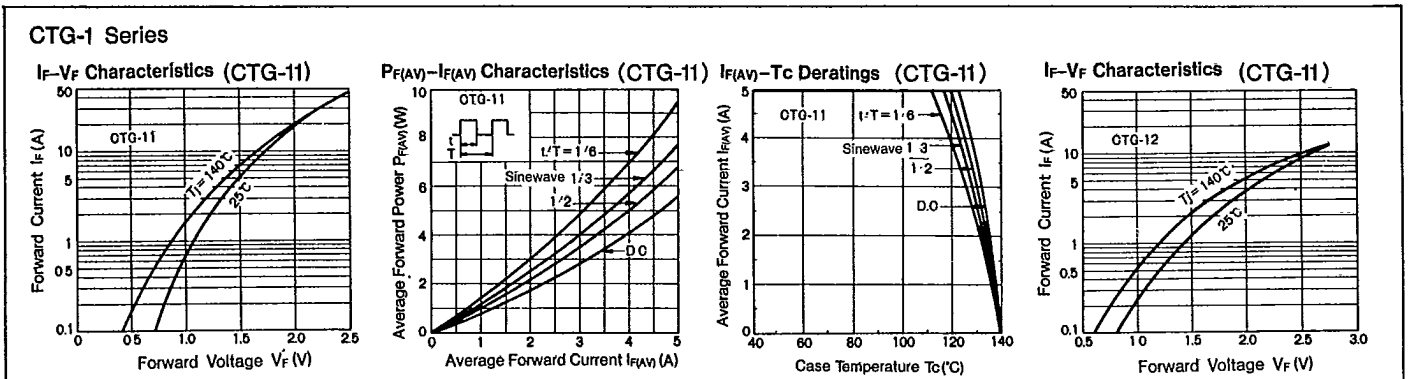

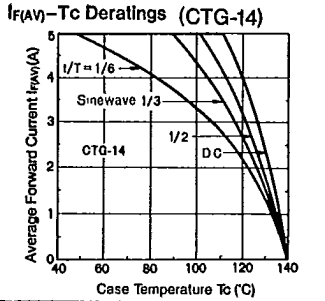
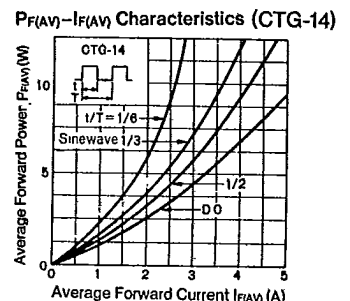
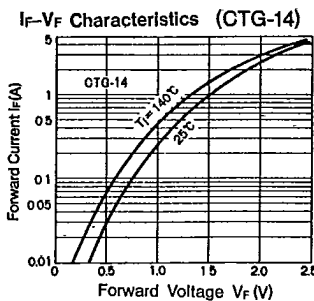
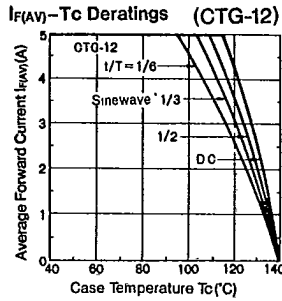
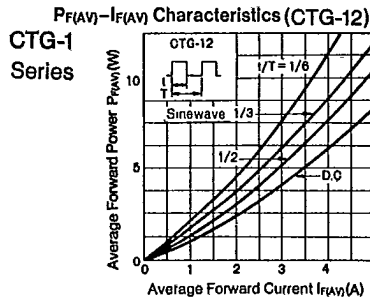

**CTG-2 Series**

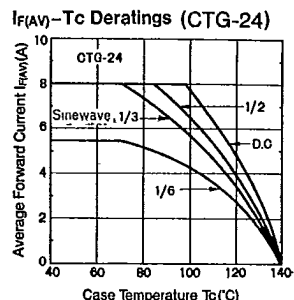
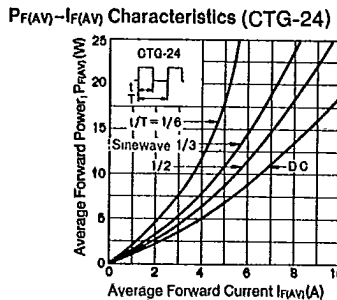
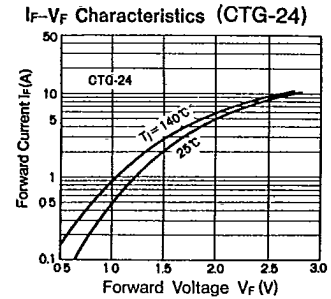
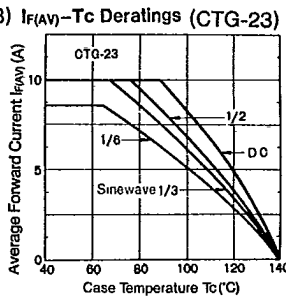
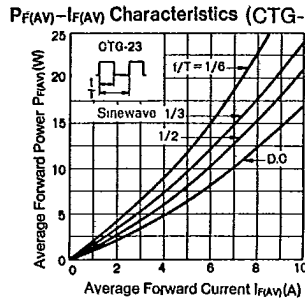
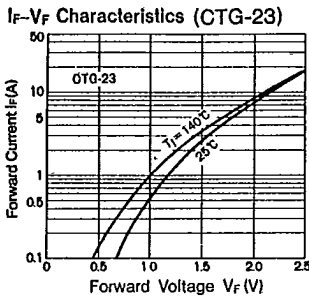
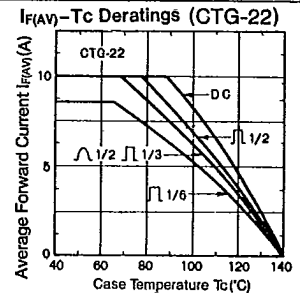
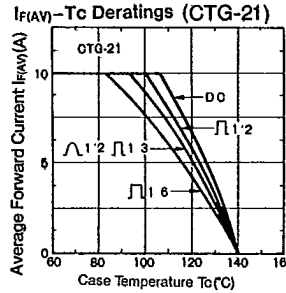

**CTG-3 Series**

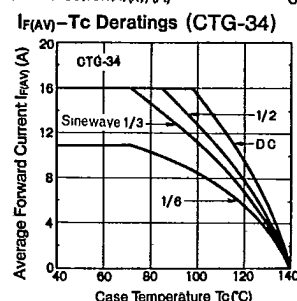
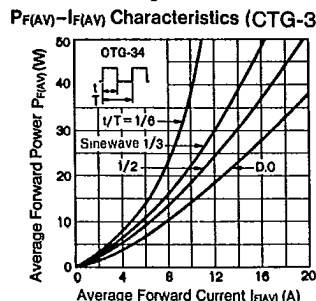
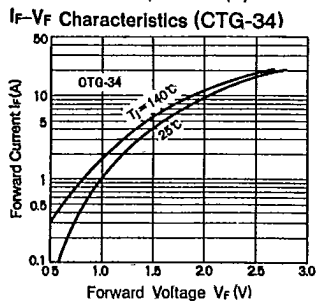
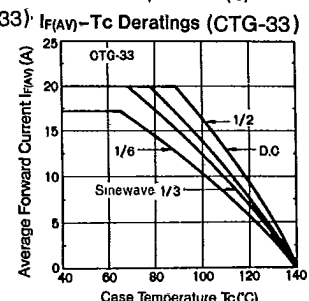
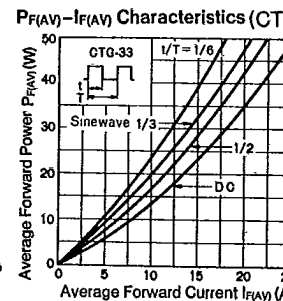
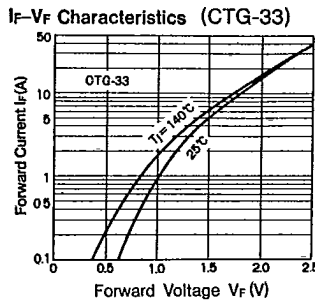
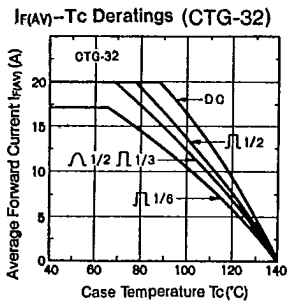
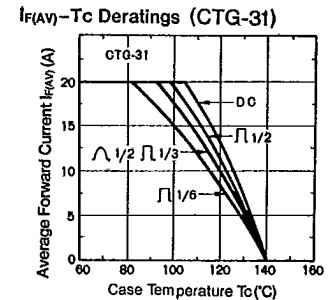

# Symbols/trr Measurement Circuit

## Symbols

$V_{RSM}$	Peak Reverse Surge Voltage	$I_{RSM}$	Peak Reverse Surge Current	$T_{stg}$	Storage Temperature
$V_{RM}$	Peak Reverse Voltage	$I_R$	Reverse Current	$t_{rr}$	Reverse Recovery Time
$V_{P-P}$	Reverse Voltage (Peak to Peak)	$I_{RP}$	Peak Reverse Current	$C_t$	Total Capacitance Between Terminals
$V_R$	Reverse Voltage	$I_{R(H)}$	Reverse Current (High Temperature)	$R_{th(j-c)}$	Thermal Resistance, Junction to Case
$V_F$	Forward Voltage	$I_Z$	Avalanche Current	$r_z$	Temperature Coefficient of Breakdown Voltage
$V_B$	Breakdown Voltage	$I_{ZSM}$	Allowable Avalanche Current	$R_z$	Equivalent Resistance of Breakdown Region
$I_o$	Average Rectified Forward Current	$T_a$	Ambient Temperature	$P_{F(AV)}$	Average Forward Power Dissipation
$I_F$	Forward Current	$T_j$	Junction Temperature	$I_t$	$I_t$ limiting Value
$I_{F(AV)}$	Average Forward Current	$T_{opr}$	Operating Ambient Temperature		
$I_{FSM}$	Peak Forward Surge Current	$T_c$	Case Temperature		

## Reverse Recovery Time Measurement Circuit

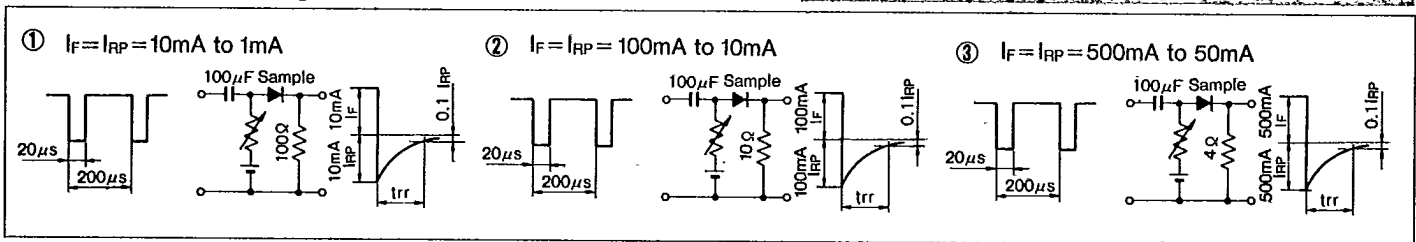

## Taping Specifications

Excluding High Voltage Diodes

Designation	Dimension (in mm)	Packaging Dimension and Marking	Quantity
<b>V</b> Add Suffix [V] to Type No.	<p><b>Tape Carrier Method</b></p> <p>(1) Right side of taping direction is cathode.                      (2) Place electrode side down when casing.                      (3) Provide leader tape of 150~200mm at beginning of tape.                      (4) Provide space of more than 10 pitches each for beginning and end of tape.</p>	<p><b>Reel</b></p> <p>Marking of Type No., Lot No. and Quantity</p>	1,800 pcs per reel
<b>V</b> Add Suffix [V] to type No.	<p><b>Axial Taping</b></p>	<p><b>Reel</b></p> <p>Markings of Type No. Lot No. and Quantity</p>	5,000 pcs per reel (2.7 φ body)  3,000 pcs per reel (4.0 φ body)

# Taping Specifications

Designation	Dimension (in mm)	Packaging Dimension and Marking	Quantity
<p><b>V1</b></p> <p>Add Suffix [V1] to Type No.</p>	<p><b>Axial Taping</b></p>	<p><b>Ammunition Pack</b></p>	<p>2,000 pcs per box (2.7 φ body)</p> <p>1,000 pcs per box (4.0 φ body)</p>
<p><b>VO</b></p> <p>Add Suffix [VO] to Type No.</p>	<p><b>Axial Taping</b></p>	<p><b>Ammunition Pack</b></p>	<p>2,000 pcs per box (2.7 φ body)</p> <p>(2.4 φ body)</p>
<p><b>V3</b></p> <p>Add Suffix [V3] to Type No.</p>	<p><b>Axial Taping</b></p>	<p><b>Reel</b></p>	<p>1,500 pcs per reel (5.2 φ body)</p>
<p><b>V4</b></p> <p>Add Suffix [V4] to Type No.</p>	<p><b>Axial Taping</b></p>	<p><b>Ammunition Pack</b></p>	<p>1,000 pcs per box (5.2 φ body)</p>
<p><b>W</b></p> <p>Add Suffix [W] to Type No.</p>	<p><b>Radial Taping</b></p>	<p><b>Ammunition Pack</b></p>	<p>4,000 pcs per box (2.7 φ body)</p> <p>(0.6 φ lead)</p>
<p><b>WS</b></p> <p>Add Suffix [WS] to Type No.</p>	<p><b>Radial Taping (Applicable to AO Series)</b></p>	<p><b>Ammunition Pack</b></p>	<p>2,500 pcs per box (2.4 φ body)</p>
<p><b>WK</b></p> <p>Add Suffix [WK] to Type No.</p>	<p><b>Radial Taping (Applicable to AO Series)</b></p>		<p>2,500 pcs per box (2.4 φ body)</p>

# Marking Guide

## 1 Small TMD

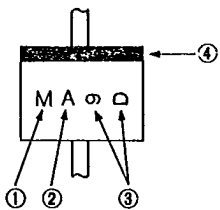

- ① Type Designation (in abbreviation)  
AM01 is abbreviated as M.
- ② Class Designation  
Z: 200V, No Letter: 400V, A: 600V
- ③ A: Year (Last Number of AD Year)  
B: Month (Jan. to Sept. are represented by numbers 1 to 9 respectively, and Oct., Nov., and Dec. are abbreviated as O, N and D respectively)
- ④ Cathode Band: Successive Band, however AU02 Type is Non-Successive Band.

## 2 E/EO Type TMD

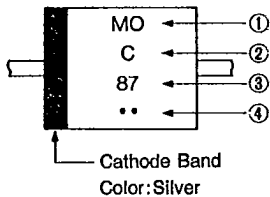

- ① Type Designation (in abbreviation)  
EM01 is abbreviated as MO, EM2 is abbreviated as M2.
- ② Class Designation  
Z: 200V, No Letter: 400V, A: 600V  
B: 800 V, C: 1000V, F: 1500V  
However, EU02A to be marked 2A, and EU2YX to be marked Y.
- ③ Abbreviations Representing Production Period  
A: Year (Last Number of AD Year)  
B: Month (1~9, O, N, D)
- ④ Production Period Divided in 3 ten day terms  
.: 1st 10days    .. : 2nd 10days    ... : 3rd 10days

## 3 R Type TMD

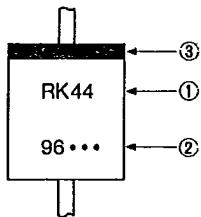

- ① Type Designation: Mark in 2 sets
- ② Production Period: Mark in 4 sets  
A: Year (Last Number of AD Year)  
B: Month (1~9, O, N, D)
- ③ Production Period Divided in 3 ten day terms  
.: 1st 10days    .. : 2nd 10days    ... : 3rd 10days
- ④ Cathode Band Color: Silver: For Power Supply  
Yellow: For Middle Speed  
Red : For High Speed and Ultra-High Speed

## 4 RB40/60

(RB40 Series)

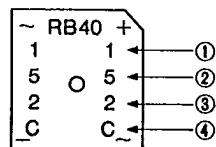

- ① Peak Reverse Voltage Designation  
1, 2, 4, 6, C  
Production Period
- ② Year (Last Number of AD Year)
- ③ Month (1~9, O, N, D)
- ④ Divided in 3 ten day terms  
A: 1st 10days, B: 2nd 10days  
C: 3rd 10days  
Color Designation: Silver

(RB60 Series)

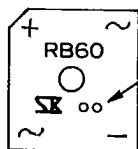

Dot Designation RB601 Violet  
RB602 No Color  
RB604 Blue  
RB606 White

## 5 RBV/RBA

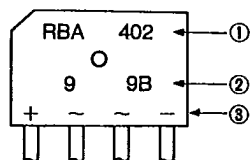

- ① Type Designation
- ② Lot Number  
1st : Year (Last Number of AD Year)  
2nd: Month (1~9, O, N, D)  
3rd : Divided 1~3 ten day Terms  
A: 1st 10 days B: 2nd 10 days  
C: 3rd 10 days
- ③ In-Put Designation

## 6 T0220 Type (FM or CT Type)

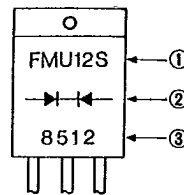

- ① Type Designation  
Show FMU-12S as FMU12S.
- ② Polarity: Rectifier Symbols
- ③ Lot Number (Laser Marking)  
1st : Year (Last Number of AD Year)  
2nd : Month (0~9, O, N, D)  
3rd, 4th: Day

## 7 T0220 Type (FM or CT Type, single chip)

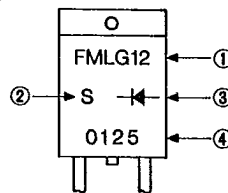

- ① Type Designation: Omit Last Letter  
Show FML-G12S as FMLG12.
- ② Last Letter of Type Designation
- ③ Polarity: Rectifier Symbols
- ④ Lot Number (Laser Marking)  
1st : Year (Last Number of AD Year)  
2nd : Month (0~9, O, N, D)  
3rd, 4th: Day

## 8 T03P Type (FM or CT Type)

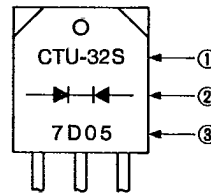

- ① Type shown in full designation  
However, CTB-34/34S/34M are marked as CTB-34, CTU-G3DR is marked as CTUG3DR.
- ② Polarity: Rectifier Symbols
- ③ Lot Number:  
1) M, U, G and L Types  
First Number : Last Digit of AD Year  
Second Number : Month  
Third and Fourth Numbers: Day  
Fifth Number : None  
2) For types CTB-34/34S/34M, the fifth letter shows type designation. If no fifth number, the type is CTB-33 or CTB-34.  
3) Marking Color: Silver

## 9 MI-10/15 Type

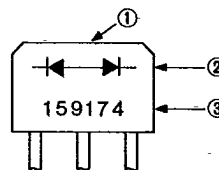

- ① MI-10/15 is die-stamped on the top of the case.
- ② Rectifier Symbols
- ③ Lot Number:  
First Number : Peak Reverse Voltage:  
(Letter) 0=50V, 1=100V, 2=200V,  
4=400V, 6=600V, C=1000V  
Second Number : Last Digit of AD Year  
Third Number : Month  
Fourth and Fifth Numbers: Day  
Sixth Number : Production number and  
U: Voltage Doubler Type

## 10 SFP Type

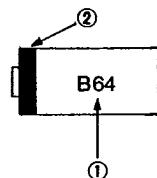

- ① Type Designation:  
SFPB-64 is abbreviated at B64.
- ② Cathode Band