

CSD87501L 30 V Dual Common Drain N-Channel NexFET™ Power MOSFET

1 Features

- Low On-Resistance
- Small Footprint of 3.37 × 1.47 mm
- Ultra-Low Profile – 0.2 mm High
- Pb-Free
- RoHS Compliant
- Halogen Free
- Gate ESD Protection

2 Applications

- Battery Management
- Battery Protection
- USB Type-C /PD

3 Description

This 30 V, 6.6 mΩ, 3.37 mm × 1.47 mm LGA Dual NexFET™ power MOSFET is designed to minimize resistance and gate charge in a small footprint. Its small size and common drain configuration make the device ideal for multi-cell battery pack applications and small handheld devices.

Top View

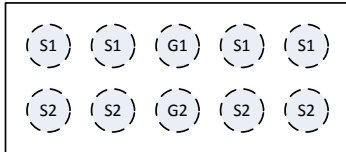

Configuration

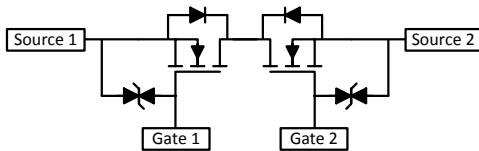

$R_{S1S2(on)}$ vs V_{GS}

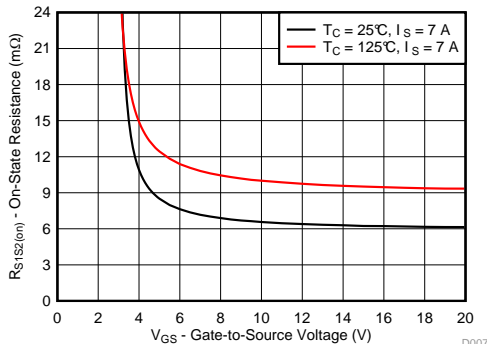

Gate Charge

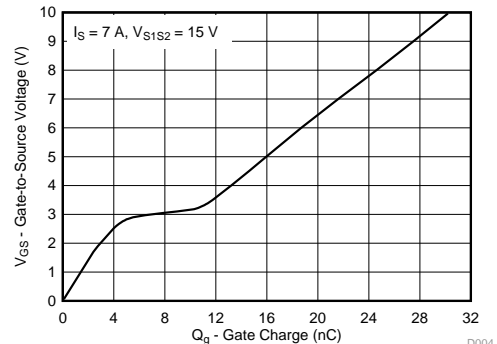

Product Summary

$T_A = 25^\circ\text{C}$		TYPICAL VALUE		UNIT
V_{S1S2}	Source-to-Source Voltage	30		V
Q_g	Gate Charge Total (4.5 V)	15		nC
Q_{gd}	Gate Charge Gate-to-Drain	6.0		nC
$R_{S1S2(on)}$	Source-to-Source On-Resistance	$V_{GS} = 4.5\text{ V}$	9.3	mΩ
		$V_{GS} = 10\text{ V}$	6.6	mΩ
$V_{GS(th)}$	Threshold Voltage	1.8		V

Ordering Information⁽¹⁾

Device	Media	Qty	Package	Ship
CSD87501L	7-Inch Reel	3000	3.37 mm X 1.47 mm Land Grid Array Package	Tape and Reel
CSD87501LT	7-Inch Reel	250		

(1) For all available packages, see the orderable addendum at the end of the data sheet.

Absolute Maximum Ratings

$T_A = 25^\circ\text{C}$		VALUE	UNIT
V_{S1S2}	Source-to-Source Voltage	30	V
V_{GS}	Gate-to-Source Voltage	±20	V
I_S	Continuous Source Current ⁽¹⁾	14	A
I_{SM}	Pulsed Source Current ⁽²⁾	72	A
P_D	Power Dissipation	2.5	W
$V_{(ESD)}$ Rating	Human Body Model (HBM)	2	kV
T_J, T_{stg}	Operating Junction and Storage Temperature Range	-55 to 150	°C

(1) Typical $R_{\theta JA} = 50^\circ\text{C/W}$ on a 1 inch², 2 oz. Cu pad on a 0.06 inch thick FR4 PCB.

(2) Typical min Cu $R_{\theta JA} = 135^\circ\text{C/W}$, pulse duration ≤100 μs, duty cycle ≤1%.



Table of Contents

1 Features	1	6 Device and Documentation Support	7
2 Applications	1	6.1 Trademarks	7
3 Description	1	6.2 Electrostatic Discharge Caution	7
4 Revision History	2	6.3 Glossary	7
5 Specifications	3	7 Mechanical, Packaging, and Orderable Information	8
5.1 Electrical Characteristics	3	7.1 Package Dimensions	8
5.2 Thermal Information	3	7.2 Recommended PCB Pattern	9
5.3 Typical MOSFET Characteristics	4	7.3 Recommended Stencil Pattern	9

4 Revision History

Changes from Original (February 2015) to Revision A	Page
• Extended Y axis in Figure 9 down to 0.01 A	5

5 Specifications

5.1 Electrical Characteristics

 $(T_A = 25^\circ\text{C}$ unless otherwise stated)

PARAMETER		TEST CONDITIONS	MIN	TYP	MAX	UNIT
STATIC CHARACTERISTICS						
BV_{S1S2}	Source-to-Source Voltage	$V_{GS} = 0\text{ V}, I_S = 250\ \mu\text{A}$	30			V
I_{S1S2}	Source-to-Source Leakage Current	$V_{GS} = 0\text{ V}, V_{S1S2} = 24\text{ V}$			1	μA
I_{GSS}	Gate-to-Source Leakage Current	$V_{S1S2} = 0\text{ V}, V_{GS} = 20\text{ V}$			10	μA
$V_{GS(th)}$	Gate-to-Source Threshold Voltage	$V_{S1S2} = V_{GS}, I_S = 250\ \mu\text{A}$	1.3	1.8	2.3	V
$R_{S1S2(on)}$	Source-to-Source On-Resistance	$V_{GS} = 4.5\text{ V}, I_S = 7\text{ A}$		9.3	11.0	$\text{m}\Omega$
		$V_{GS} = 10\text{ V}, I_S = 7\text{ A}$		6.6	7.8	$\text{m}\Omega$
g_{fs}	Transconductance	$V_{S1S2} = 3\text{ V}, I_S = 7\text{ A}$		48		S
DYNAMIC CHARACTERISTICS⁽¹⁾						
C_{iss}	Input Capacitance	$V_{GS} = 0\text{ V}, V_{S1S2} = 15\text{ V}, f = 1\text{ MHz}$		1620	2110	pF
C_{oss}	Output Capacitance			189	246	pF
C_{rss}	Reverse Transfer Capacitance			152	198	pF
R_G	Series Gate Resistance			300	450	Ω
Q_g	Gate Charge Total (4.5 V)	$V_{S1S2} = 15\text{ V}, I_S = 7\text{ A}$		15	20	nC
Q_g	Gate Charge Total (10 V)			31	40	nC
Q_{gd}	Gate Charge Gate-to-Drain			6.0		nC
Q_{gs}	Gate Charge Gate-to-Source			5.0		nC
$Q_{g(th)}$	Gate Charge at V_{th}			2.5		nC
Q_{oss}	Output Charge		$V_{S1S2} = 15\text{ V}, V_{GS} = 0\text{ V}$		7.6	
$t_{d(on)}$	Turn On Delay Time	$V_{S1S2} = 15\text{ V}, V_{GS} = 10\text{ V}, I_{S1S2} = 7\text{ A}, R_G = 0\ \Omega$		164		ns
t_r	Rise Time			260		ns
$t_{d(off)}$	Turn Off Delay Time			709		ns
t_f	Fall Time			712		ns

(1) Dynamic characteristics values specified are per single FET.

5.2 Thermal Information

 $(T_A = 25^\circ\text{C}$ unless otherwise stated)

THERMAL METRIC		MIN	TYP	MAX	UNIT
$R_{\theta JA}$	Junction-to-Ambient Thermal Resistance ⁽¹⁾		135		$^\circ\text{C}/\text{W}$
	Junction-to-Ambient Thermal Resistance ⁽²⁾		50		

(1) Device mounted on FR4 material with minimum Cu mounting area.

(2) Device mounted on FR4 material with 1 inch² (6.45 cm²), 2 oz. (0.071 mm thick) Cu.

5.3 Typical MOSFET Characteristics

($T_A = 25^\circ\text{C}$ unless otherwise stated)

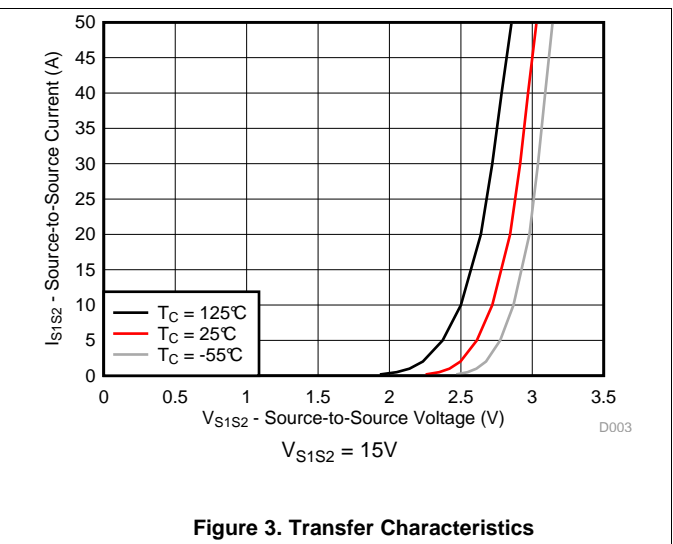
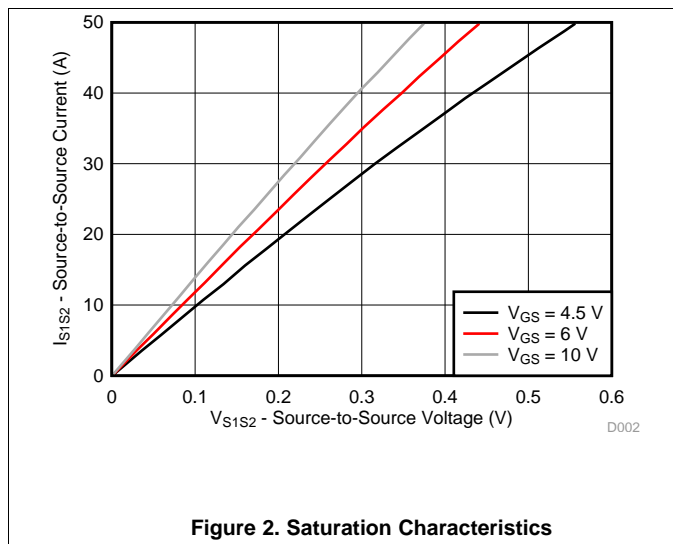
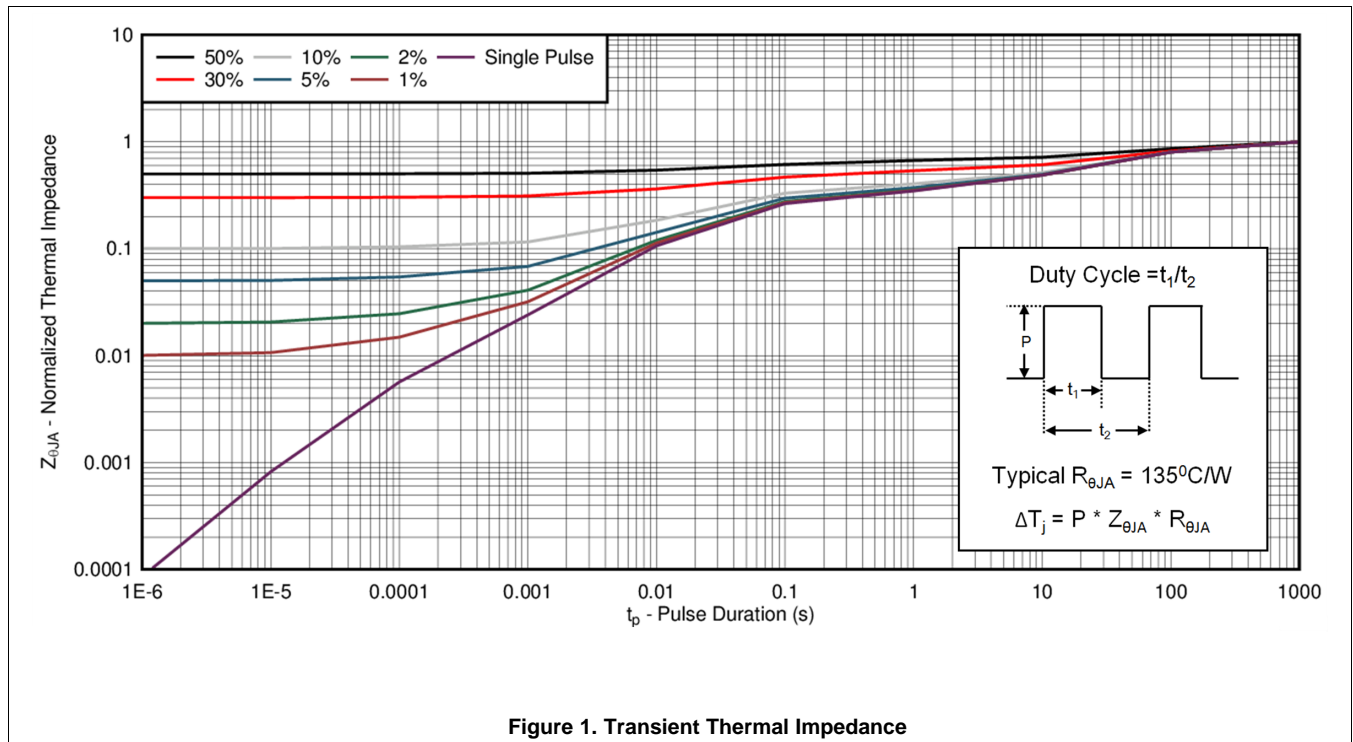

Typical MOSFET Characteristics (continued)

($T_A = 25^\circ\text{C}$ unless otherwise stated)

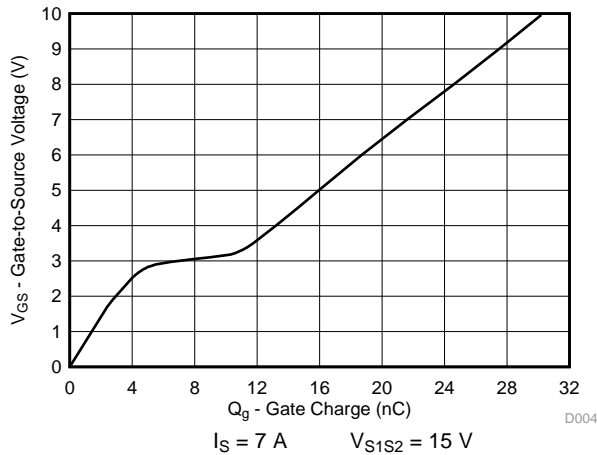

Figure 4. Gate Charge

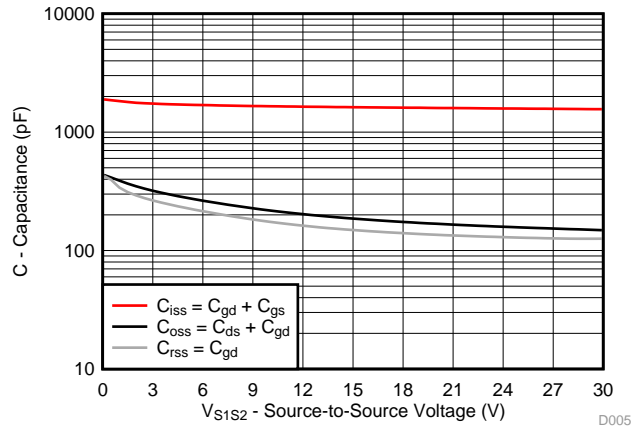

Figure 5. Capacitance

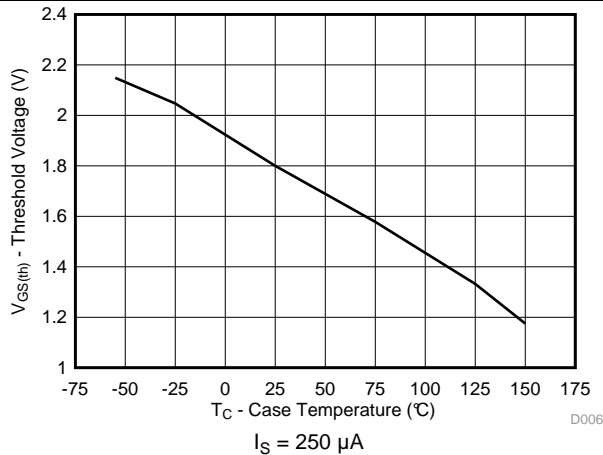

Figure 6. Threshold Voltage vs Temperature

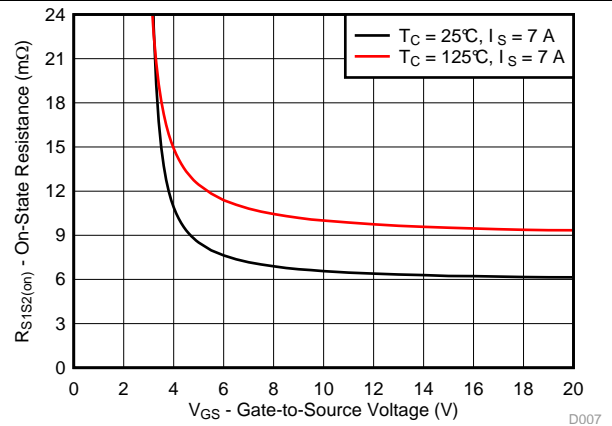

Figure 7. On-State Source-to-Source Resistance vs Gate-to-Source Voltage

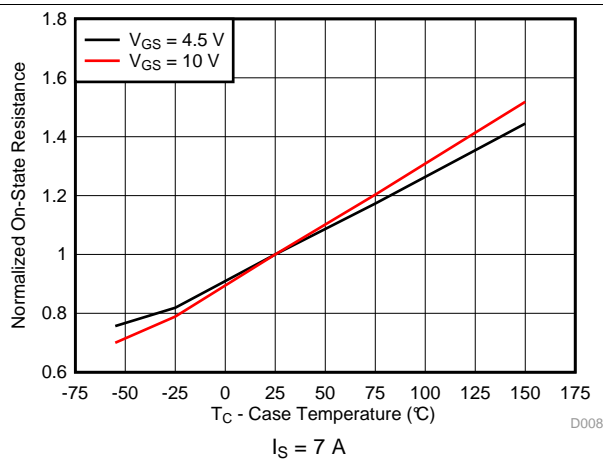

Figure 8. Normalized On-State Resistance vs Temperature

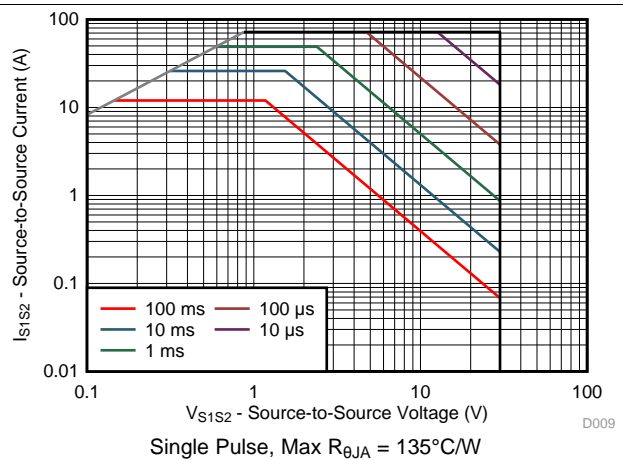

Figure 9. Maximum Safe Operating Area

Typical MOSFET Characteristics (continued)

($T_A = 25^\circ\text{C}$ unless otherwise stated)

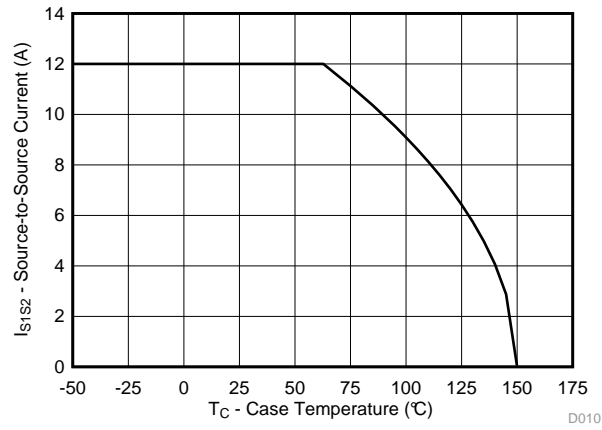

Figure 10. Maximum Source Current vs Temperature

6 Device and Documentation Support

6.1 Trademarks

NexFET is a trademark of Texas Instruments.
All other trademarks are the property of their respective owners.

6.2 Electrostatic Discharge Caution



These devices have limited built-in ESD protection. The leads should be shorted together or the device placed in conductive foam during storage or handling to prevent electrostatic damage to the MOS gates.

6.3 Glossary

[SLYZ022](#) — *TI Glossary*.

This glossary lists and explains terms, acronyms, and definitions.

7 Mechanical, Packaging, and Orderable Information

The following pages include mechanical, packaging, and orderable information. This information is the most current data available for the designated devices. This data is subject to change without notice and revision of this document. For browser-based versions of this data sheet, refer to the left-hand navigation.

7.1 Package Dimensions

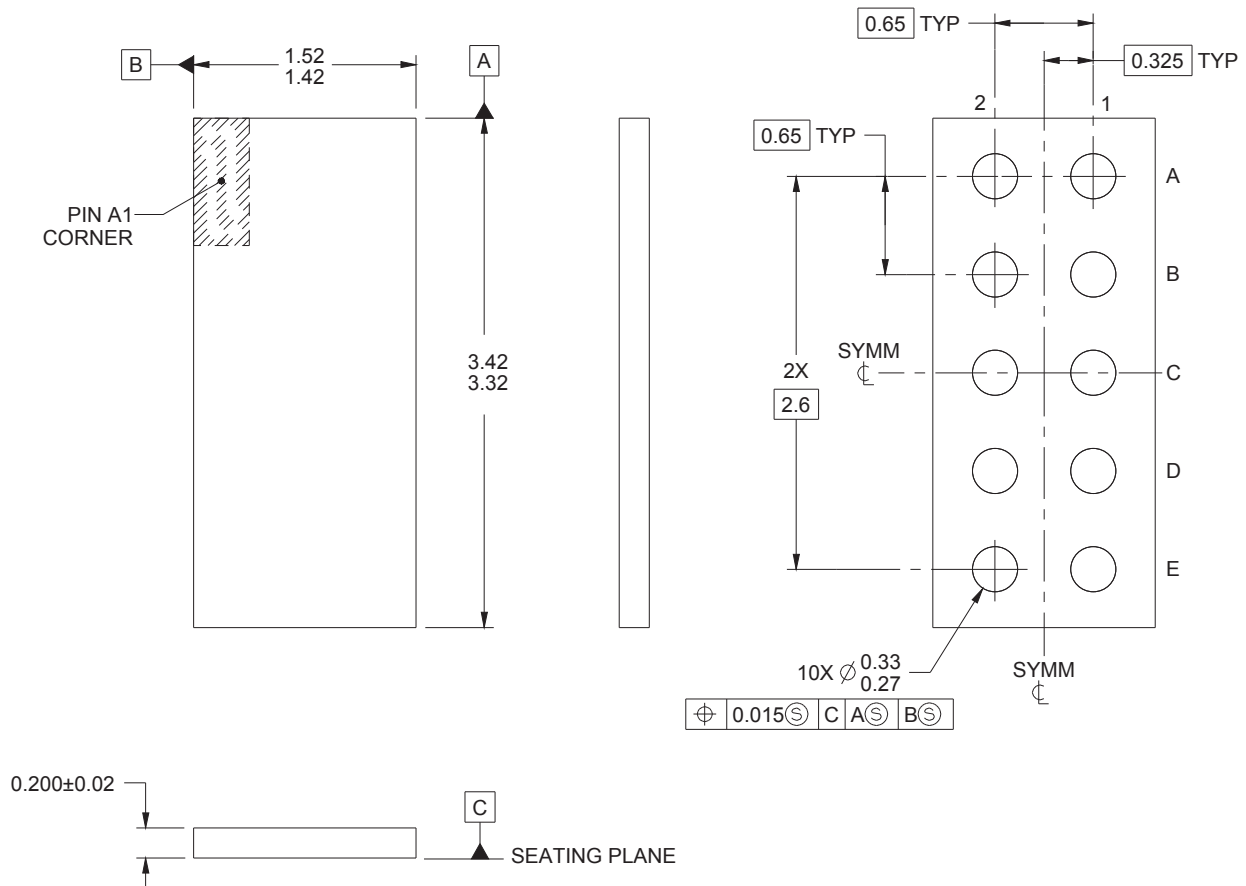

All dimensions in millimeters.

7.2 Recommended PCB Pattern

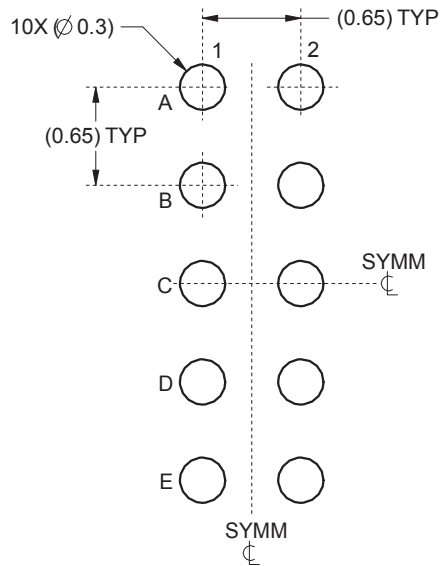

7.3 Recommended Stencil Pattern

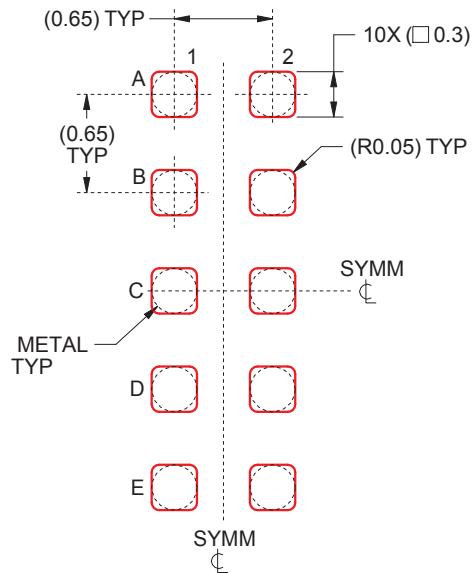

All dimensions are in millimeters unless otherwise noted.

PACKAGING INFORMATION

Orderable Device	Status (1)	Package Type	Package Drawing	Pins	Package Qty	Eco Plan (2)	Lead/Ball Finish (6)	MSL Peak Temp (3)	Op Temp (°C)	Device Marking (4/5)	Samples
CSD87501L	ACTIVE	PICOSTAR	YJG	10	3000	Green (RoHS & no Sb/Br)	Call TI	Level-1-260C-UNLIM		CSD87501	Samples
CSD87501LT	ACTIVE	PICOSTAR	YJG	10	250	Green (RoHS & no Sb/Br)	Call TI	Level-1-260C-UNLIM		CSD87501	Samples

(1) The marketing status values are defined as follows:

ACTIVE: Product device recommended for new designs.

LIFEBUY: TI has announced that the device will be discontinued, and a lifetime-buy period is in effect.

NRND: Not recommended for new designs. Device is in production to support existing customers, but TI does not recommend using this part in a new design.

PREVIEW: Device has been announced but is not in production. Samples may or may not be available.

OBSOLETE: TI has discontinued the production of the device.

(2) Eco Plan - The planned eco-friendly classification: Pb-Free (RoHS), Pb-Free (RoHS Exempt), or Green (RoHS & no Sb/Br) - please check <http://www.ti.com/productcontent> for the latest availability information and additional product content details.

TBD: The Pb-Free/Green conversion plan has not been defined.

Pb-Free (RoHS): TI's terms "Lead-Free" or "Pb-Free" mean semiconductor products that are compatible with the current RoHS requirements for all 6 substances, including the requirement that lead not exceed 0.1% by weight in homogeneous materials. Where designed to be soldered at high temperatures, TI Pb-Free products are suitable for use in specified lead-free processes.

Pb-Free (RoHS Exempt): This component has a RoHS exemption for either 1) lead-based flip-chip solder bumps used between the die and package, or 2) lead-based die adhesive used between the die and leadframe. The component is otherwise considered Pb-Free (RoHS compatible) as defined above.

Green (RoHS & no Sb/Br): TI defines "Green" to mean Pb-Free (RoHS compatible), and free of Bromine (Br) and Antimony (Sb) based flame retardants (Br or Sb do not exceed 0.1% by weight in homogeneous material)

(3) MSL, Peak Temp. - The Moisture Sensitivity Level rating according to the JEDEC industry standard classifications, and peak solder temperature.

(4) There may be additional marking, which relates to the logo, the lot trace code information, or the environmental category on the device.

(5) Multiple Device Markings will be inside parentheses. Only one Device Marking contained in parentheses and separated by a "~" will appear on a device. If a line is indented then it is a continuation of the previous line and the two combined represent the entire Device Marking for that device.

(6) Lead/Ball Finish - Orderable Devices may have multiple material finish options. Finish options are separated by a vertical ruled line. Lead/Ball Finish values may wrap to two lines if the finish value exceeds the maximum column width.

Important Information and Disclaimer: The information provided on this page represents TI's knowledge and belief as of the date that it is provided. TI bases its knowledge and belief on information provided by third parties, and makes no representation or warranty as to the accuracy of such information. Efforts are underway to better integrate information from third parties. TI has taken and continues to take reasonable steps to provide representative and accurate information but may not have conducted destructive testing or chemical analysis on incoming materials and chemicals. TI and TI suppliers consider certain information to be proprietary, and thus CAS numbers and other limited information may not be available for release.

In no event shall TI's liability arising out of such information exceed the total purchase price of the TI part(s) at issue in this document sold by TI to Customer on an annual basis.

IMPORTANT NOTICE

Texas Instruments Incorporated and its subsidiaries (TI) reserve the right to make corrections, enhancements, improvements and other changes to its semiconductor products and services per JESD46, latest issue, and to discontinue any product or service per JESD48, latest issue. Buyers should obtain the latest relevant information before placing orders and should verify that such information is current and complete. All semiconductor products (also referred to herein as "components") are sold subject to TI's terms and conditions of sale supplied at the time of order acknowledgment.

TI warrants performance of its components to the specifications applicable at the time of sale, in accordance with the warranty in TI's terms and conditions of sale of semiconductor products. Testing and other quality control techniques are used to the extent TI deems necessary to support this warranty. Except where mandated by applicable law, testing of all parameters of each component is not necessarily performed.

TI assumes no liability for applications assistance or the design of Buyers' products. Buyers are responsible for their products and applications using TI components. To minimize the risks associated with Buyers' products and applications, Buyers should provide adequate design and operating safeguards.

TI does not warrant or represent that any license, either express or implied, is granted under any patent right, copyright, mask work right, or other intellectual property right relating to any combination, machine, or process in which TI components or services are used. Information published by TI regarding third-party products or services does not constitute a license to use such products or services or a warranty or endorsement thereof. Use of such information may require a license from a third party under the patents or other intellectual property of the third party, or a license from TI under the patents or other intellectual property of TI.

Reproduction of significant portions of TI information in TI data books or data sheets is permissible only if reproduction is without alteration and is accompanied by all associated warranties, conditions, limitations, and notices. TI is not responsible or liable for such altered documentation. Information of third parties may be subject to additional restrictions.

Resale of TI components or services with statements different from or beyond the parameters stated by TI for that component or service voids all express and any implied warranties for the associated TI component or service and is an unfair and deceptive business practice. TI is not responsible or liable for any such statements.

Buyer acknowledges and agrees that it is solely responsible for compliance with all legal, regulatory and safety-related requirements concerning its products, and any use of TI components in its applications, notwithstanding any applications-related information or support that may be provided by TI. Buyer represents and agrees that it has all the necessary expertise to create and implement safeguards which anticipate dangerous consequences of failures, monitor failures and their consequences, lessen the likelihood of failures that might cause harm and take appropriate remedial actions. Buyer will fully indemnify TI and its representatives against any damages arising out of the use of any TI components in safety-critical applications.

In some cases, TI components may be promoted specifically to facilitate safety-related applications. With such components, TI's goal is to help enable customers to design and create their own end-product solutions that meet applicable functional safety standards and requirements. Nonetheless, such components are subject to these terms.

No TI components are authorized for use in FDA Class III (or similar life-critical medical equipment) unless authorized officers of the parties have executed a special agreement specifically governing such use.

Only those TI components which TI has specifically designated as military grade or "enhanced plastic" are designed and intended for use in military/aerospace applications or environments. Buyer acknowledges and agrees that any military or aerospace use of TI components which have **not** been so designated is solely at the Buyer's risk, and that Buyer is solely responsible for compliance with all legal and regulatory requirements in connection with such use.

TI has specifically designated certain components as meeting ISO/TS16949 requirements, mainly for automotive use. In any case of use of non-designated products, TI will not be responsible for any failure to meet ISO/TS16949.

Products

Audio	www.ti.com/audio
Amplifiers	amplifier.ti.com
Data Converters	dataconverter.ti.com
DLP® Products	www.dlp.com
DSP	dsp.ti.com
Clocks and Timers	www.ti.com/clocks
Interface	interface.ti.com
Logic	logic.ti.com
Power Mgmt	power.ti.com
Microcontrollers	microcontroller.ti.com
RFID	www.ti-rfid.com
OMAP Applications Processors	www.ti.com/omap
Wireless Connectivity	www.ti.com/wirelessconnectivity

Applications

Automotive and Transportation	www.ti.com/automotive
Communications and Telecom	www.ti.com/communications
Computers and Peripherals	www.ti.com/computers
Consumer Electronics	www.ti.com/consumer-apps
Energy and Lighting	www.ti.com/energy
Industrial	www.ti.com/industrial
Medical	www.ti.com/medical
Security	www.ti.com/security
Space, Avionics and Defense	www.ti.com/space-avionics-defense
Video and Imaging	www.ti.com/video

TI E2E Community

e2e.ti.com