



# CPH6445

## N-Channel Power MOSFET 60V, 3.5A, 117mΩ, Single CPH6

ON Semiconductor®

<http://onsemi.com>

### Features

- 4V drive
- Low ON-resistance
- Protection diode in

### Specifications

#### Absolute Maximum Ratings at Ta=25°C

Parameter	Symbol	Conditions	Ratings	Unit
Drain-to-Source Voltage	V <sub>DSS</sub>		60	V
Gate-to-Source Voltage	V <sub>GSS</sub>		±20	V
Drain Current (DC)	I <sub>D</sub>		3.5	A
Drain Current (Pulse)	I <sub>DP</sub>	PW≤10μs, duty cycle≤1%	14	A
Allowable Power Dissipation	P <sub>D</sub>	When mounted on ceramic substrate (1200mm <sup>2</sup> ×0.8mm)	1.6	W
Channel Temperature	T <sub>ch</sub>		150	°C
Storage Temperature	T <sub>stg</sub>		-55 to +150	°C

Stresses exceeding those listed in the Maximum Ratings table may damage the device. If any of these limits are exceeded, device functionality should not be assumed, damage may occur and reliability may be affected.

### Package Dimensions

unit : mm (typ)

7018A-003

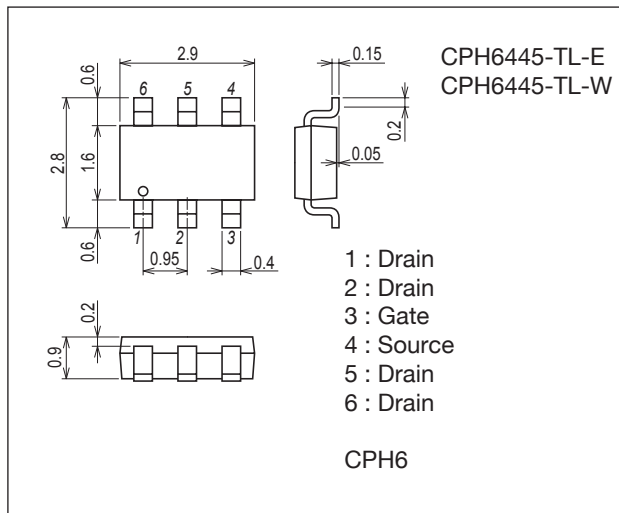

### Product & Package Information

- Package : CPH6
- JEITA, JEDEC : SC-74, SOT-26, SOT-457
- Minimum Packing Quantity : 3,000 pcs./reel

### Packing Type: TL

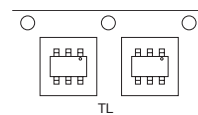

### Marking

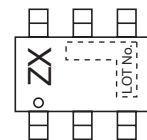

### Electrical Connection

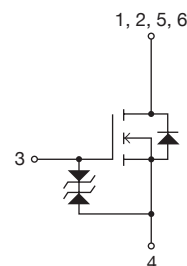

### ORDERING INFORMATION

See detailed ordering and shipping information on page 2 of this data sheet.

# CPH6445

## Electrical Characteristics at Ta=25°C

Parameter	Symbol	Conditions	Ratings			Unit
			min	typ	max	
Drain-to-Source Breakdown Voltage	$V_{(BR)DSS}$	$I_D=1mA, V_{GS}=0V$	60			V
Zero-Gate Voltage Drain Current	$I_{DSS}$	$V_{DS}=60V, V_{GS}=0V$			1	$\mu A$
Gate-to-Source Leakage Current	$I_{GSS}$	$V_{GS}=\pm 16V, V_{DS}=0V$			$\pm 10$	$\mu A$
Cutoff Voltage	$V_{GS(off)}$	$V_{DS}=10V, I_D=1mA$	1.2		2.6	V
Forward Transfer Admittance	$ y_{fs} $	$V_{DS}=10V, I_D=1.5A$	1.2	2.0		S
Static Drain-to-Source On-State Resistance	$R_{DS(on)1}$	$I_D=1.5A, V_{GS}=10V$		92	117	$m\Omega$
	$R_{DS(on)2}$	$I_D=0.7A, V_{GS}=4.5V$		120	168	$m\Omega$
	$R_{DS(on)3}$	$I_D=0.7A, V_{GS}=4V$		132	185	$m\Omega$
Input Capacitance	$C_{iss}$	$V_{DS}=20V, f=1MHz$		310		pF
Output Capacitance	$C_{oss}$			40		pF
Reverse Transfer Capacitance	$C_{rss}$			25		pF
Turn-ON Delay Time	$t_{d(on)}$		See specified Test Circuit.		6.0	
Rise Time	$t_r$			5.5		ns
Turn-OFF Delay Time	$t_{d(off)}$			27		ns
Fall Time	$t_f$			13		ns
Total Gate Charge	$Q_g$	$V_{DS}=30V, V_{GS}=10V, I_D=3.5A$			6.8	
Gate-to-Source Charge	$Q_{gs}$			1.1		nC
Gate-to-Drain "Miller" Charge	$Q_{gd}$			1.4		nC
Diode Forward Voltage	$V_{SD}$		$I_S=3.5A, V_{GS}=0V$		0.85	1.2

Product parametric performance is indicated in the Electrical Characteristics for the listed test conditions, unless otherwise noted. Product performance may not be indicated by the Electrical Characteristics if operated under different conditions.

## Switching Time Test Circuit

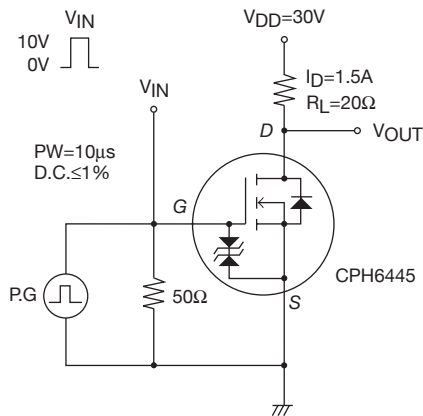

## Ordering Information

Device	Package	Shipping	memo
CPH6445-TL-E	CPH6	3,000pcs./reel	Pb-Free
CPH6445-TL-W			Pb-Free and Halogen Free

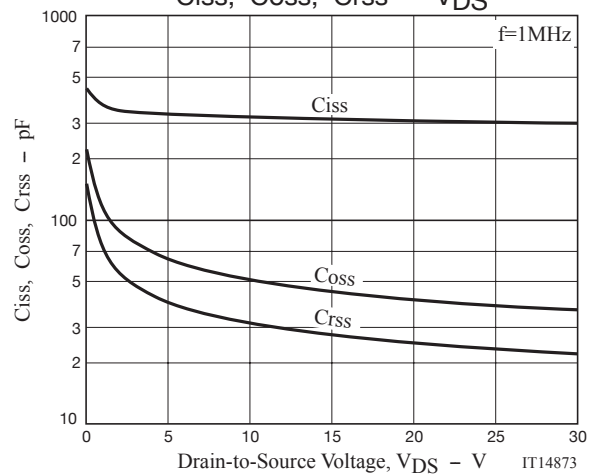
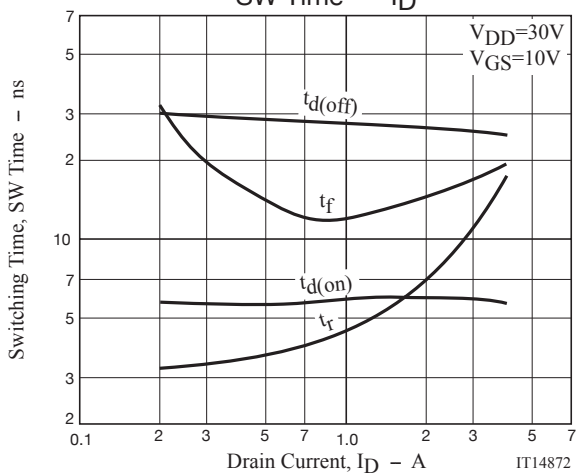
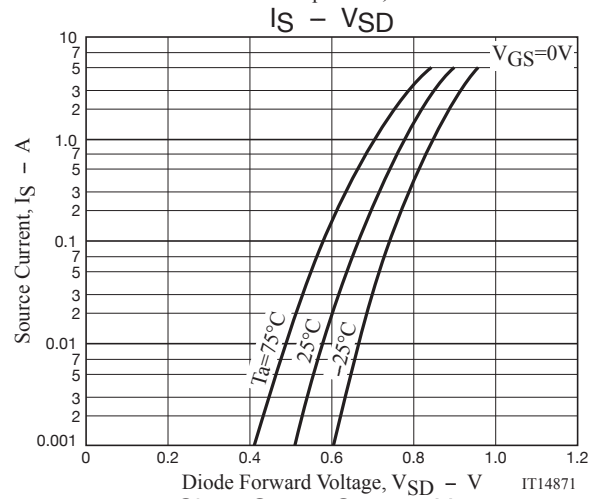
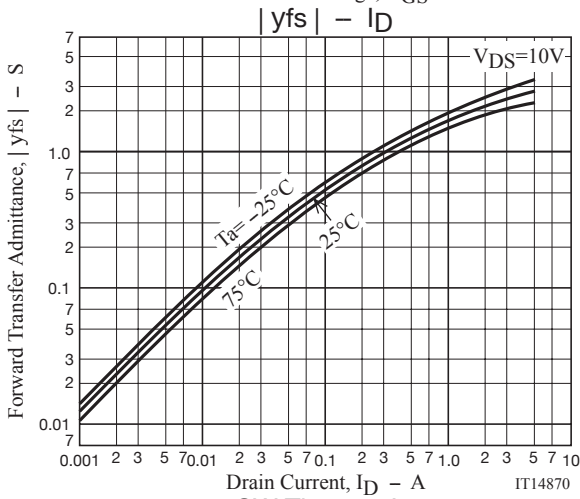
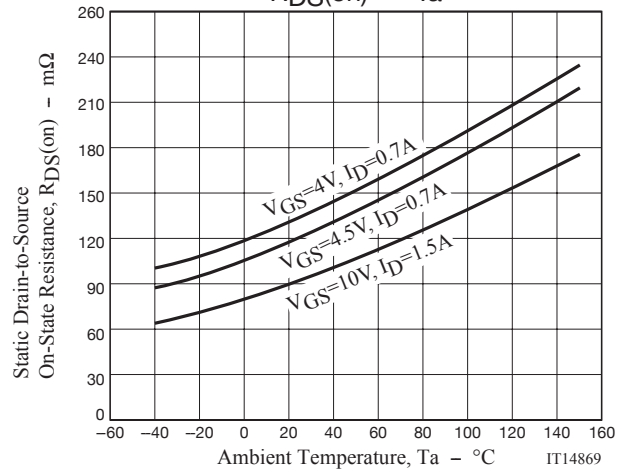
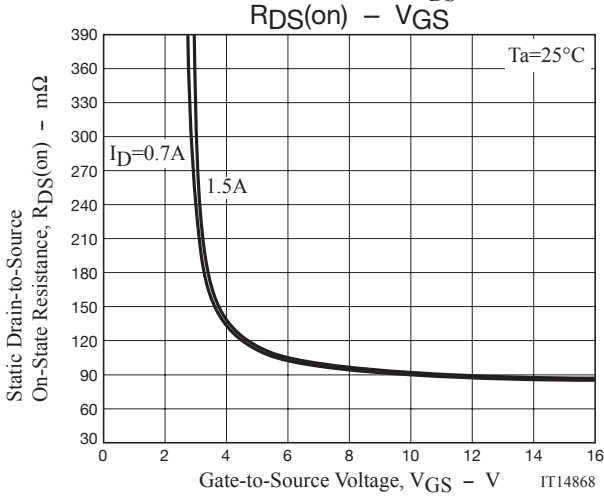
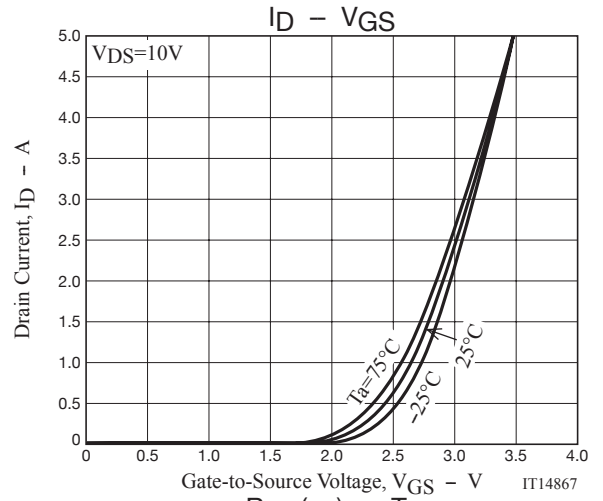
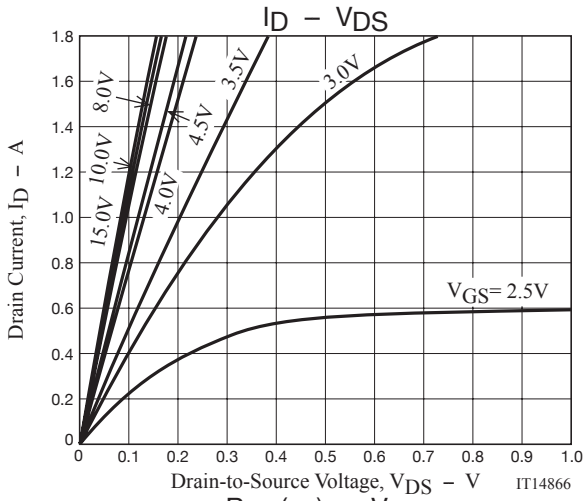

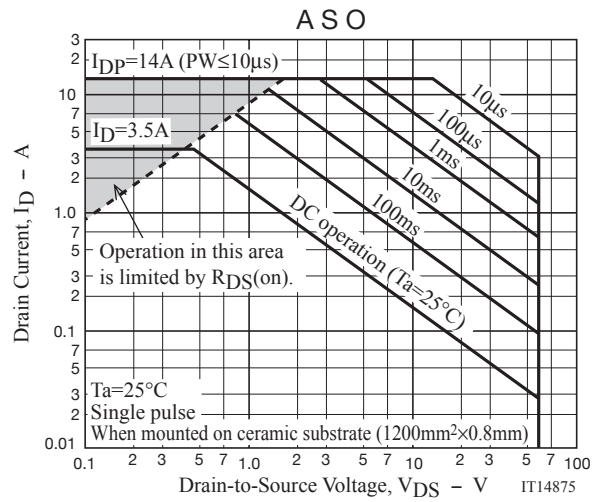
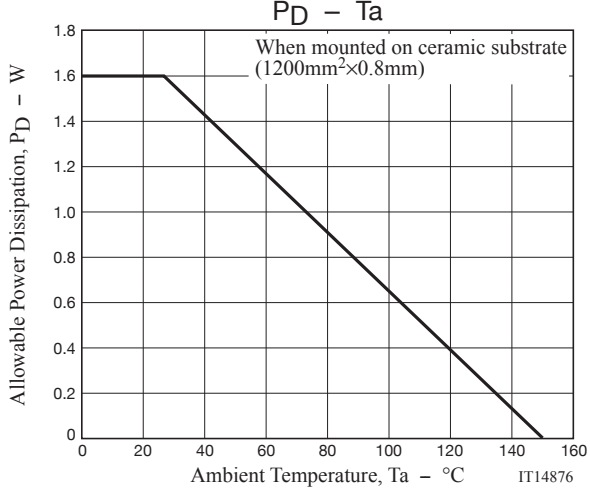
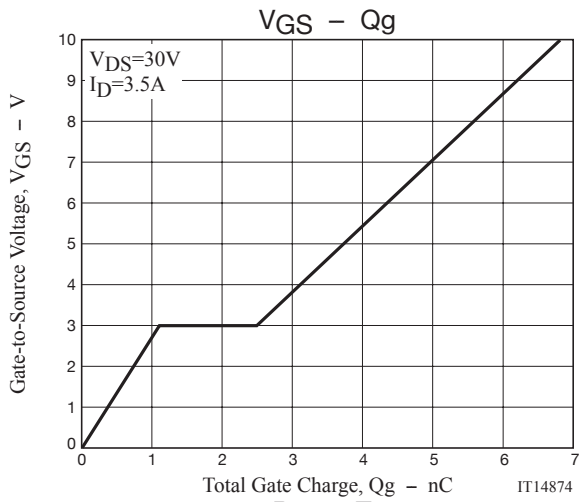



# Mouser Electronics

Authorized Distributor

Click to View Pricing, Inventory, Delivery & Lifecycle Information:

[onsemi:](#)

[CPH6445-TL-E](#) [CPH6445-TL-W](#)