

# Cree® PLCC6 3 in 1 SMD LED

## CLYBB-FKA



### PRODUCT DESCRIPTION

This SMD LED features an IPx8 water resistant rating in a PLCC6 package. These high performance tricolor SMT LEDs are designed to work in a wide range of applications. A wide viewing angle and high brightness make these LEDs suitable for outdoor and full color video signage applications.

The encapsulation resin contains UV inhibitors to minimize the effects of long-term exposure to direct sunlight, resulting in stable light output over the life of the LED. This PLCC6 package has an increased package height to ease in the manufacturing process.

### FEATURES

- Size (mm): 2.8x2.8x2.3
- Dominant Wavelength:  
Red (619 - 624nm)  
Green (520 - 535nm)  
Blue (465 - 475nm)
- Luminous Intensity (mcd)  
Red (280 - 560)  
Green (560 - 1120)  
Blue (101 - 202)
- Water-Resistant (IPx8)\*
- Moisture Sensitivity Level: 5a
- Lead-Free
- RoHS Compliant

### APPLICATIONS

- Outdoor Full-Color Video Screen
- Decorative lighting
- Amusement

\*: This part is tested under the condition of assembling it on a PCB with isolating the electrical path by silicone. The leads area of the LED is not IPx8 rated and it's required to insulate for moisture by customer in outdoor application.

### ABSOLUTE MAXIMUM RATINGS ( $T_A = 25^\circ\text{C}$ )

Items	Symbol	Absolute Maximum Rating			Unit
		R	G	B	
Forward Current <sup>Note 1</sup>	$I_F$	50	35	20	mA
Peak Forward Current <sup>Note 2</sup>	$I_{FP}$	200	100	100	mA
Reverse Voltage	$V_R$	5	5	5	V
Power Dissipation	$P_D$	130	119	72	mW
Operation Temperature	$T_{opr}$	-40 ~ +85			$^\circ\text{C}$
Storage Temperature	$T_{stg}$	-40 ~ +100			$^\circ\text{C}$
Junction Temperature	$T_J$	110	110	110	$^\circ\text{C}$
Junction/ambient 1 chip on	$R_{THJA}$	440	480	420	$^\circ\text{C}/\text{W}$
Junction/solder point 1 chip on	$R_{THJS}$	180	230	200	$^\circ\text{C}/\text{W}$
Electrostatic Discharge Classification(MIL-STD-883E)	ESD	1000 V			

**Note:** 1.Single-color light.  
2.Pulse width  $\leq 0.1$  msec, duty  $\leq 1/10$ .

### TYPICAL ELECTRICAL & OPTICAL CHARACTERISTICS ( $T_A = 25^\circ\text{C}$ )

Characteristics	Condition	Symbol	Values			Unit
			R	G	B	
Dominant Wavelength	$I_F = 15$ mA(R) $I_F = 10$ mA(G) $I_F = 10$ mA(B)	$\lambda_{DOM}$	619~624	520~535	465~475	nm
Spectral bandwidth at 50% $I_{REL}$ max	$I_F = 15$ mA(R) $I_F = 10$ mA(G) $I_F = 10$ mA(B)	$\Delta \lambda$	24	38	28	nm
Forward Voltage	$I_F = 15$ mA(R) $I_F = 10$ mA(G) $I_F = 10$ mA(B)	$V_{F(avg)}$	2.1	2.7	2.8	V
		$V_{F(max)}$	2.6	3.4	3.6	V
Luminous Intensity	$I_F = 15$ mA(R) $I_F = 10$ mA(G) $I_F = 10$ mA(B)	$I_{V(min)}$	280	560	101	mcd
		$I_{V(avg)}$	420	730	135	mcd
Luminous Intensity(Reference)	$I_F = 20$ mA(R/G/B)	$I_{V(avg)}$	550	1220	245	mcd
Reverse Current (max)	$V_R = 5$ V	$I_R$	10	10	10	$\mu\text{A}$

**Note:** Continuous reverse voltage can cause LED damage.

**INTENSITY BIN LIMIT (RED  $I_F = 15$  mA, GREEN  $I_F = 10$  mA, BLUE  $I_F = 10$  mA)**

Red			Green			Blue		
Bin Code	Min.(mcd)	Max.(mcd)	Bin Code	Min.(mcd)	Max.(mcd)	Bin Code	Min.(mcd)	Max.(mcd)
G	280	355	K	560	710	56	101	126
fg	318	403	np	635	805	C	112	140
H	355	450	M	710	900	78	126	160
hj	403	505	qr	805	1010	D	140	180
J	450	560	N	900	1120	9a	160	202

Tolerance of measurement of luminous intensity is  $\pm 10\%$ .

**COLOR BIN LIMIT (RED  $I_F = 15$  mA, GREEN  $I_F = 10$  mA, BLUE  $I_F = 10$  mA)**

Red			Green			Blue		
Bin Code	Min.(nm)	Max.(nm)	Bin Code	Min.(nm)	Max.(nm)	Bin Code	Min.(nm)	Max.(nm)
RB	619	624	G7	520	525	B4	465	470
			G23	522.5	527.5	B45	467.5	472.5
			G8	525	530	B5	470	475
			G45	527.5	532.5			
			G9	530	535			

Tolerance of measurement of dominant wavelength is  $\pm 1$  nm.

**ORDER CODE TABLE\***

Kit Number	Color	Luminous Intensity (mcd)		Dominant Wavelength (nm)				Pack- age
		Min.	Max.	Color Bin	Min. (nm)	Color Bin	Max. (nm)	
CLYBB-FKA-CGJKN569aBB79453	Red	280	560	RB	619	RB	624	Reel
	Green	560	1120	G7	520	G9	535	Reel
	Blue	101	202	B4	465	B5	475	Reel
CLYBB-FKA-CG1K1561BB7C4S3	Red	Any 1 Intensity bin from G(280) - J(560)		RB	619	RB	624	Reel
	Green	Any 1 Intensity bin from K(560) - N(1120)		Any 1 hue bin from G7(520) - G9(535)			Reel	
	Blue	Any 1 Intensity bin from 56(101) - 9a(202)		Any 1 hue bin from B4(465) - B5(475)			Reel	
CLYBB-FKA-CH1np1C1BB7C4S3	Red	Any 1 Intensity bin from H(355) - J(560)		RB	619	RB	624	Reel
	Green	Any 1 Intensity bin from np(635) - N(1120)		Any 1 hue bin from G7(520) - G9(535)			Reel	
	Blue	Any 1 Intensity bin from C(112) - 9a(202)		Any 1 hue bin from B4(465) - B5(475)			Reel	

Notes:

1. The above kit numbers represent the order codes which include multiple intensity-bin and color-bin codes. Only one intensity-bin code and one color-bin code will be shipped on each reel. Single intensity-bin code and single color-bin code will be orderable in certain quantities. For example, any 1 intensity bin from K - N means only 1 intensity bin (K or np or M or qr or N) will be shipped by Cree. For example, any 1 color bin from G7 - G9 means only 1 color bin (G7 or G23 or G8 or G45 or G9) will be shipped by Cree.
2. Please refer to the "Cree LED Lamp Reliability Test Standards" document #1 for reliability test conditions.
3. Please refer to the "Cree LED Lamp Soldering & Handling" document #2 for information about how to use this LED product safely.

#1: Refer to [http://www.cree.com/led-components/media/documents/LED\\_Lamp\\_Reliability\\_Test\\_Standard.pdf](http://www.cree.com/led-components/media/documents/LED_Lamp_Reliability_Test_Standard.pdf)

#2: Refer to <http://www.cree.com/led-components/media/documents/sh-HB.pdf>

## GRAPHS

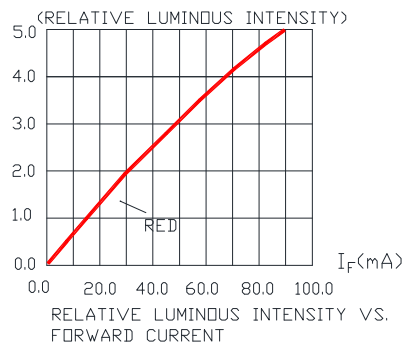
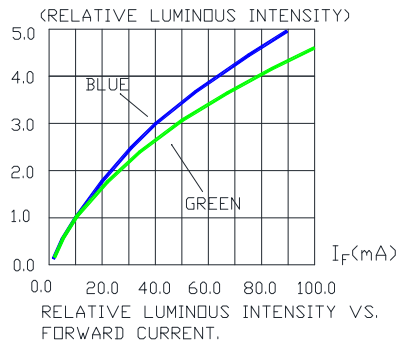
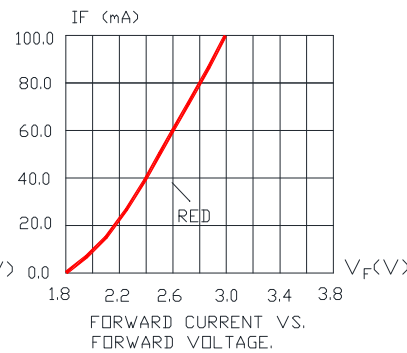
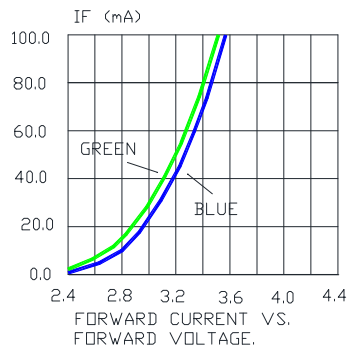
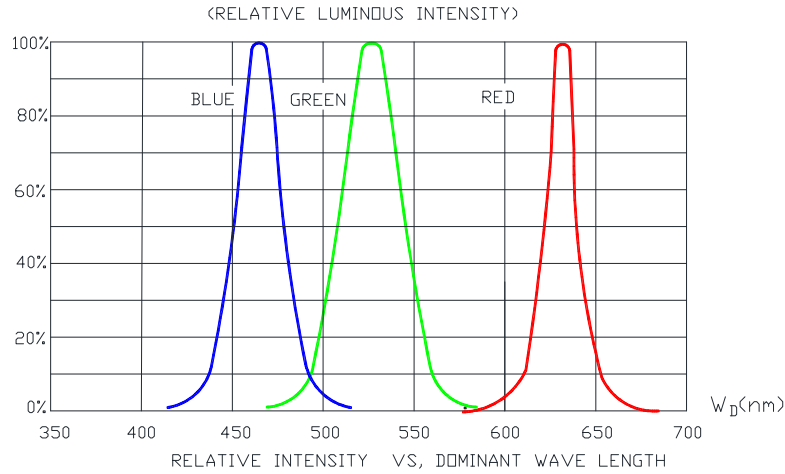

The above data are collected from statistical figures that do not necessarily correspond to the actual parameters of each single LED. Hence, these data will be changed without further notice.

## GRAPHS

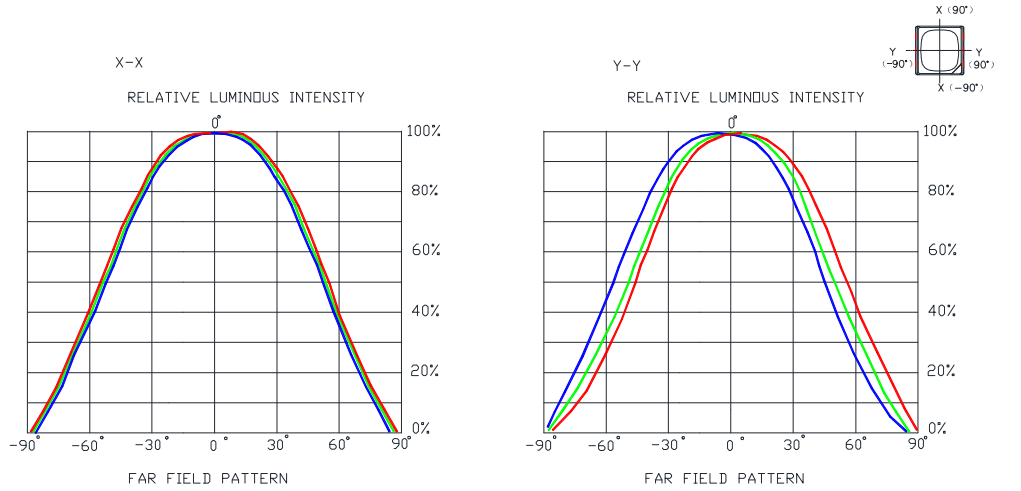

FAR FIELD PATTERN

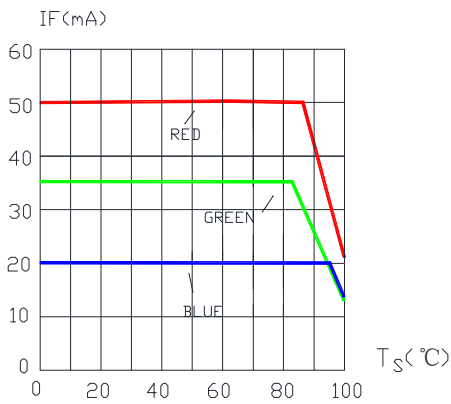

MAXIMUM FORWARD DC CURRENT VS, SOLDER POINT TEMPERATURE.

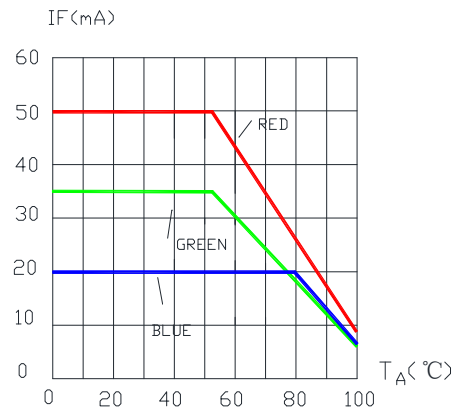

MAXIMUM FORWARD DC CURRENT VS, AMBIENT TEMPERATURE.

The above data are collected from statistical figures that do not necessarily correspond to the actual parameters of each single LED. Hence, these data will be changed without further notice.

## MECHANICAL DIMENSIONS

All dimensions are in mm.

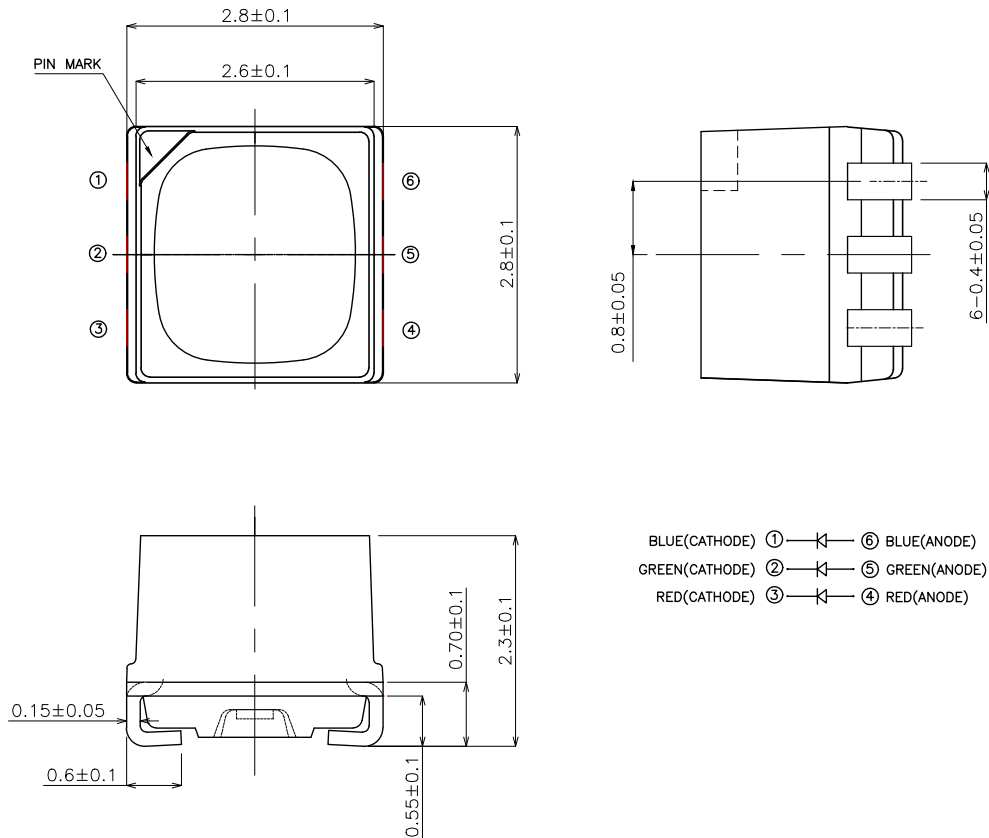

## NOTES

### RoHS Compliance

The levels of RoHS-restricted materials in this product are below the maximum concentration values (also referred to as the threshold limits) permitted for such substances, or are used in an exempted application in accordance with EU Directive 2011/65/EC (RoHS2), as implemented by EU member states on January 2, 2013 and amended on March 31, 2015 by EU Directive 2015/863/EU.

RoHS Declarations for this product can be obtained from your Cree representative or from the Product Ecology section of the Cree website.

### Vision Advisory Claim

Users should be cautioned not to stare at the light of this LED product. The bright light can damage the eye.

## KIT NUMBER SYSTEM

Cree LED lamps are tested and sorted into performance bins. A bin is specified by ranges of color, forward voltage, and brightness. Sorted LEDs are packaged for shipping in various convenient options. Please refer to the "Cree LED Lamp Packaging Standard" document for more information about shipping and packaging options.

Cree LEDs are sold by order codes in combinations of bins called kits. Order codes are configured in the following manner:

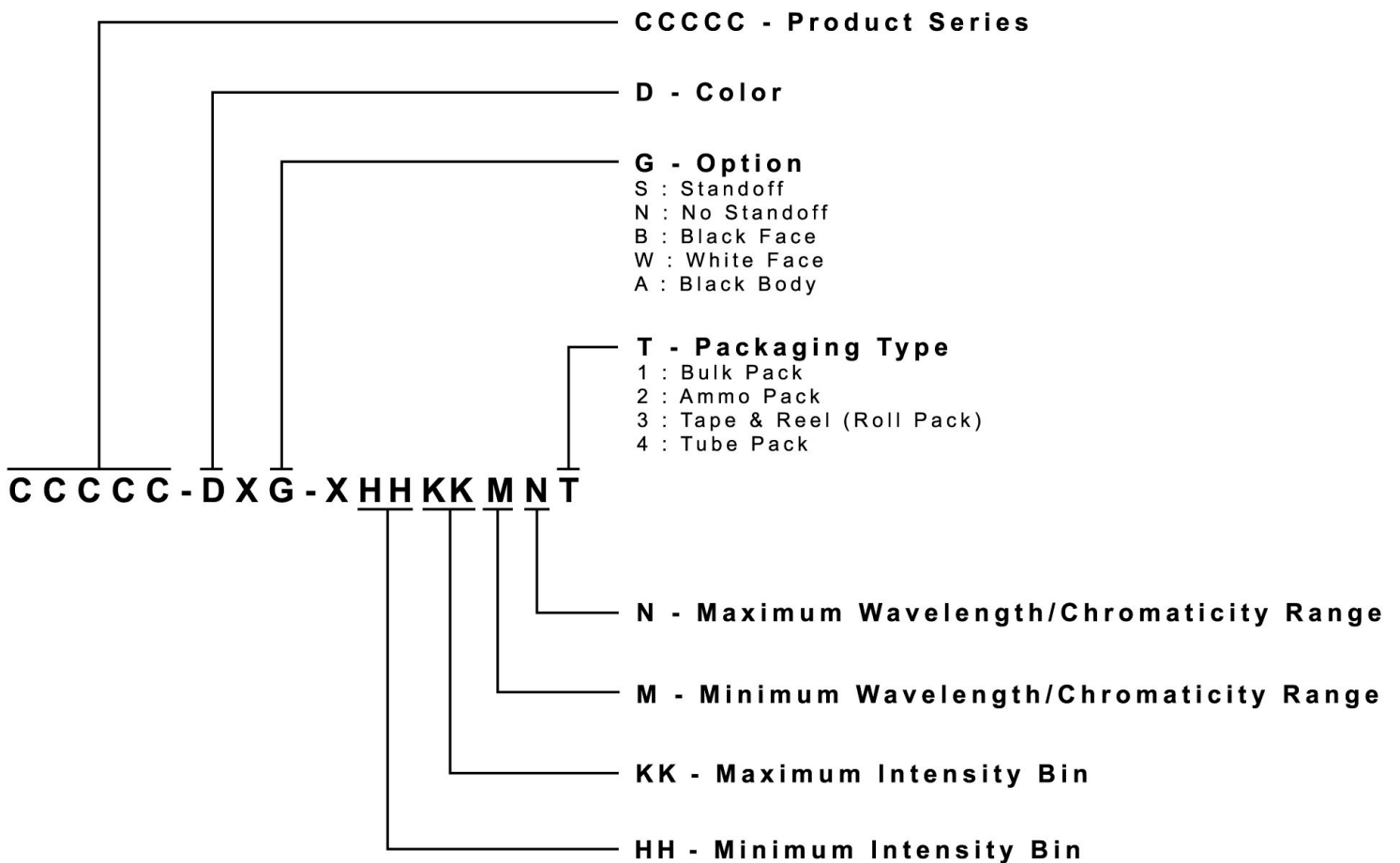

## REFLOW SOLDERING

- The CLYBB-FKA is rated as a MSL 5a product.
- The recommended floor life out of bag is 24hrs.
- The temperature profile is as below.

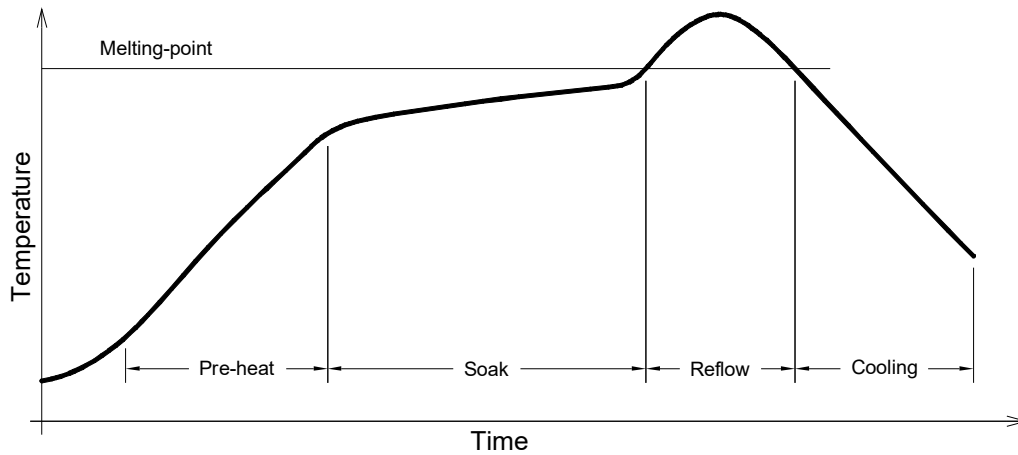

Use only with CLYBB-FKA

Solder
Average ramp-up rate = 4°C/s max
Preheat temperature = 150°C ~200°C
Preheat time = 120s max
Ramp-down rate = 6°C/s max
Peak temperature = 235°C max
Time within 5°C of actual Peak Temperature = 10s max
Duration above 217°C is 45s max

Refer to "<http://www.cree.com/led-components/media/documents/sh-HB.pdf>" for soldering & handling details.

## NOTES

---

- The packaging sizes of these SMD products are very small and the resin is still soft after solidification. Users are required to handle with care. Never touch the resin surface of SMD products.
- To avoid damaging the product's surface and interior device, it is recommended to choose a special nozzle to pick up the SMD products during the process of SMT production. If handling is necessary, take special care when picking up these products. The following method is necessary:

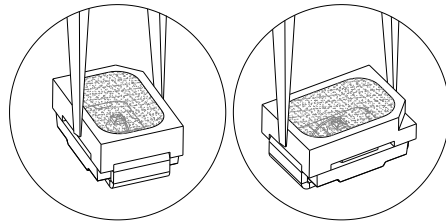

## PACKAGING

- The boxes are not water resistant and they must be kept away from water and moisture.
- The LEDs are packed in cardboard boxes after packaging in normal or anti-electrostatic bags.
- Cardboard boxes will be used to protect the LEDs from mechanical shocks during transportation.
- The reel pack is applied in SMD LED.
- Max 6500 pcs per reel.

