

# CGH55030F1 / CGH55030P1

30 W, 5500-5800 MHz, 28V, GaN HEMT for WiMAX

## Description

Cree's CGH55030F1/CGH55030P1 is a gallium nitride (GaN) high electron mobility transistor (HEMT) designed specifically for high efficiency, high gain and wide bandwidth capabilities, which makes the CGH55030F1/CGH55030P1 ideal for 5.5-5.8 GHz WiMAX and BWA amplifier applications. The transistor is available in both screw-down, flange and solder-down, pill packages. Based on appropriate external match adjustment, the CGH55030F1/CGH55030P1 is suitable for 4.9 - 5.5 GHz applications as well.

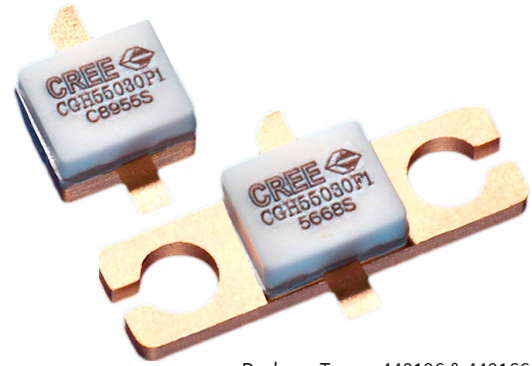

Package Types: 440196 & 440166  
PN: CGH55030P1 & CGH55030F1

## Typical Performance Over 5.5-5.8GHz ( $T_c = 25^\circ\text{C}$ ) of Demonstration Amplifier

Parameter	5.50 GHz	5.65 GHz	5.80 GHz	Units
Small Signal Gain	9.5	10.0	9.5	dB
EVM at $P_{AVE} = 29\text{ dBm}$	1.1	0.9	0.9	%
EVM at $P_{AVE} = 36\text{ dBm}$	2.2	1.4	1.4	%
Drain Efficiency at $P_{AVE} = 4\text{ W}$	23	24	25	%
Input Return Loss	10.8	22	9.3	dB

Note: Measured in the CGH55030-AMP amplifier circuit, under 802.16 OFDM, 3.5 MHz Channel BW, 1/4 Cyclic Prefix, 64 QAM Modulated Burst, Symbol Length of 59, Coding Type RS-CC, Coding Rate Type 2/3, PAR = 9.8 dB @ 0.01 % Probability on CCDF.

## Features

- 300 MHz Instantaneous Bandwidth
- 30 W Peak Power Capability
- 10 dB Small Signal Gain
- 4 W  $P_{AVE} < 2.0\%$  EVM
- 25% Efficiency at 4 W Average Power
- Designed for WiMAX Fixed Access 802.16-2004 OFDM Applications
- Designed for Multi-carrier DOCSIS Applications

 Large Signal Models Available for ADS and MWO

**RoHS**  
COMPLIANT

**Absolute Maximum Ratings (not simultaneous) at 25 °C Case Temperature**

Parameter	Symbol	Rating	Units	Conditions
Drain-Source Voltage	$V_{DSS}$	120	Volts	25 °C
Gate-to-Source Voltage	$V_{GS}$	-10, +2	Volts	25 °C
Power Dissipation	$P_{DISS}$	14	Watts	
Storage Temperature	$T_{STG}$	-65, +150	°C	
Operating Junction Temperature	$T_J$	225	°C	
Maximum Forward Gate Current	$I_{GMAX}$	7.0	mA	25 °C
Maximum Drain Current <sup>1</sup>	$I_{DMAX}$	3	A	25 °C
Soldering Temperature <sup>2</sup>	$T_S$	245	°C	
Screw Torque	$\tau$	40	in-oz	
Thermal Resistance, Junction to Case <sup>3</sup>	$R_{\theta JC}$	4.8	°C/W	85 °C
Case Operating Temperature <sup>3</sup>	$T_C$	-40, +150	°C	30 seconds

Notes:

<sup>1</sup> Current limit for long term, reliable operation<sup>2</sup> Refer to the Application Note on soldering at [wolfspeed.com/rf/document-library](http://wolfspeed.com/rf/document-library)<sup>3</sup> Measured for the CGH55030F1 at  $P_{DISS} = 14$  W**Electrical Characteristics ( $T_C = 25$  °C)**

Characteristics	Symbol	Min.	Typ.	Max.	Units	Conditions
<b>DC Characteristics<sup>1</sup></b>						
Gate Threshold Voltage	$V_{GS(th)}$	-3.8	-3.0	-2.3	$V_{DC}$	$V_{DS} = 10$ V, $I_D = 7.2$ mA
Gate Quiescent Voltage	$V_{GS(Q)}$	-	-2.7	-	$V_{DC}$	$V_{DS} = 28$ V, $I_D = 250$ mA
Saturated Drain Current	$I_{DS}$	5.8	7.0	-	A	$V_{DS} = 6.0$ V, $V_{GS} = 2$ V
Drain-Source Breakdown Voltage	$V_{BR}$	84	-	-	$V_{DC}$	$V_{GS} = -8$ V, $I_D = 7.2$ mA
<b>RF Characteristics<sup>2</sup> (<math>T_C = 25</math> °C, <math>F_0 = 5.65</math> GHz unless otherwise noted)</b>						
Small Signal Gain	$G_{SS}$	8.5	10.0	-	dB	$V_{DD} = 28$ V, $I_{DQ} = 250$ mA
Drain Efficiency <sup>4</sup>	$\eta$	19	24	-	%	$V_{DD} = 28$ V, $I_{DQ} = 250$ mA, $P_{AVE} = 4$ W
Error Vector Magnitude	EVM	-	2.0	2.5	%	$V_{DD} = 28$ V, $I_{DQ} = 250$ mA, $P_{AVE} = 4$ W
Output Mismatch Stress	VSWR	-	-	10 : 1	$\Psi$	No damage at all phase angles, $V_{DD} = 28$ V, $I_{DQ} = 250$ mA, $P_{AVE} = 4$ W
<b>Dynamic Characteristics</b>						
Input Capacitance	$C_{GS}$	-	9.0	-	pF	$V_{DS} = 28$ V, $V_{GS} = -8$ V, $f = 1$ MHz
Output Capacitance	$C_{DS}$	-	2.6	-	pF	$V_{DS} = 28$ V, $V_{GS} = -8$ V, $f = 1$ MHz
Feedback Capacitance	$C_{GD}$	-	0.4	-	pF	$V_{DS} = 28$ V, $V_{GS} = -8$ V, $f = 1$ MHz

Notes:

<sup>1</sup> Measured on wafer prior to packaging.<sup>2</sup> Measured in the CGH55030-AMP test fixture.<sup>3</sup> Under 802.16 OFDM, 3.5 MHz Channel BW, 1/4 Cyclic Prefix, 64 QAM Modulated Burst, 5 ms Burst, Symbol Length of 59, Coding Type RS-CC, Coding Rate Type 2/3, PAR = 9.8 dB @ 0.01 % Probability on CCDF<sup>4</sup> Drain Efficiency =  $P_{OUT} / P_{DC}$



Typical WiMAX Performance

Small Signal S-Parameters vs Frequency of  
CGH55030F1 and CGH55030P1 in the CGH55030-AMP  
 $V_{DD} = 28\text{ V}, I_{DQ} = 250\text{ mA}$

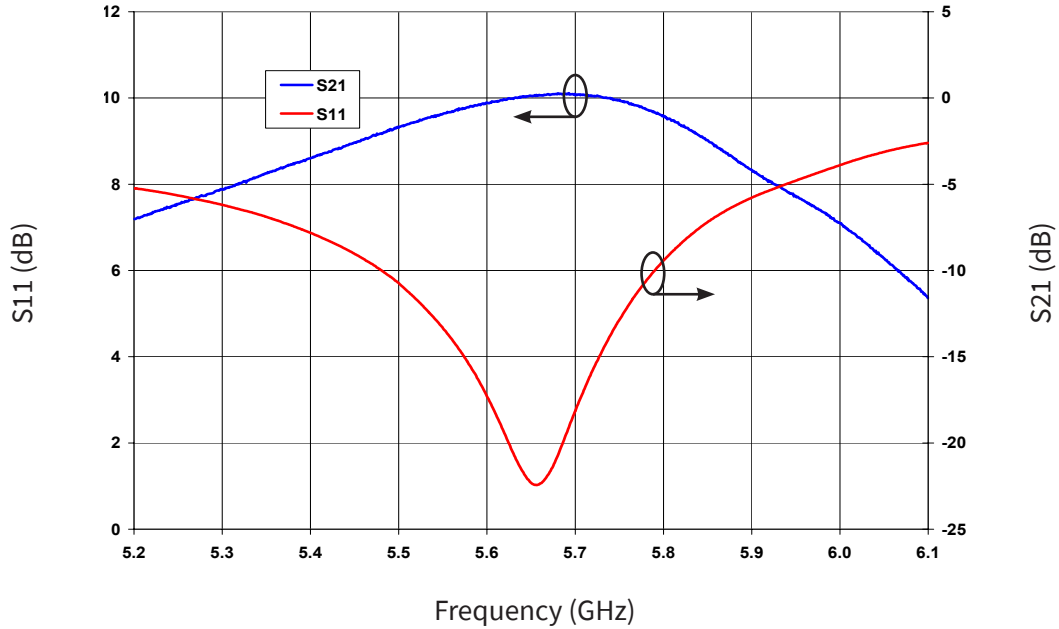

Typical EVM and Efficiency versus Frequency of  
CGH55030F1 and CGH55030P1 in the CGH55030-AMP  
 $V_{DD} = 28\text{ V}, I_{DQ} = 250\text{ mA}, 802.16\text{-}2004\text{ OFDM}, \text{PAR}=9.8\text{ dB}, P_{AVE} = 5\text{ W}$

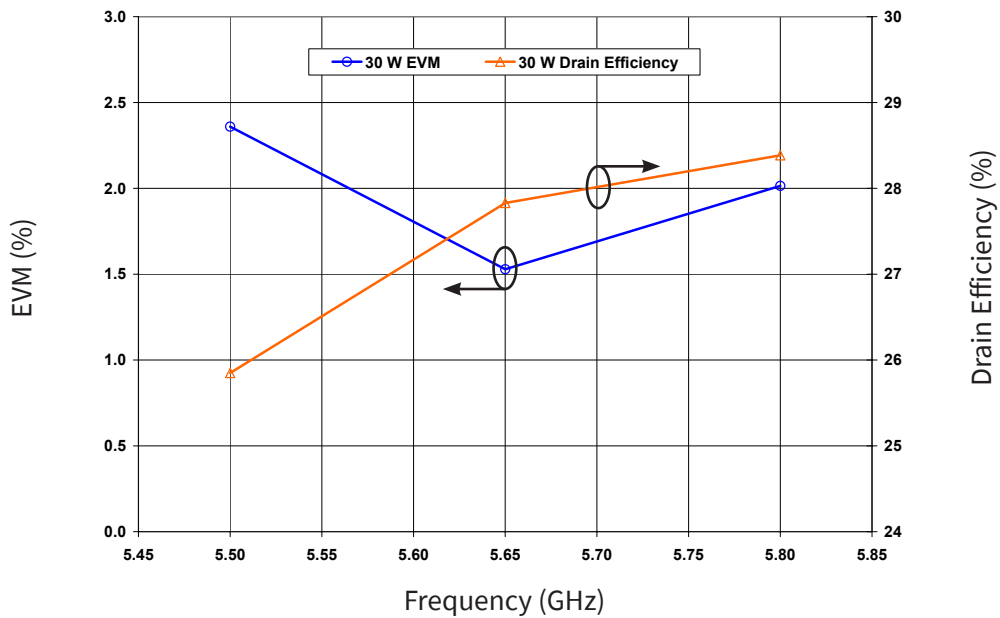

Note:

Under 802.16 OFDM, 3.5 MHz Channel BW, 1/4 Cyclic Prefix, 64 QAM Modulated Burst, Symbol Length of 59, Coding Type RS-CC, Coding Rate Type 2/3, PAR = 9.8 dB @ 0.01 % Probability on CCDF



Typical WiMAX Performance

**Drain Efficiency and Gain vs Output Power of CGH55030F1 and CGH55030P1 in CGH55030-AMP**  
**VDD = 28 V, IDQ = 250 mA, 802.16-2004 OFDM, PAR=9.8 dB**

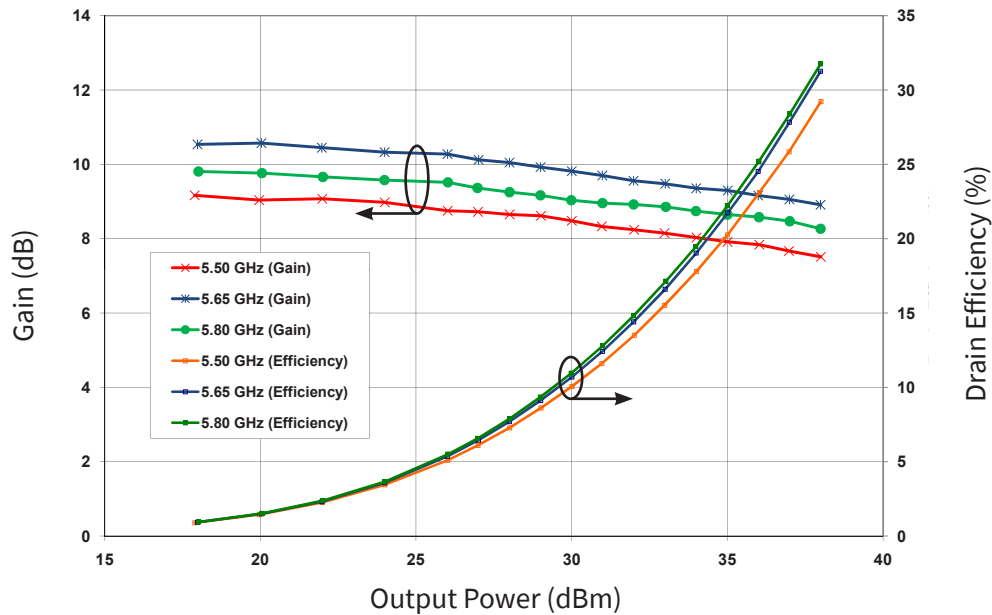

Note:  
 Under 802.16 OFDM, 3.5 MHz Channel BW, 1/4 Cyclic Prefix, 64 QAM Modulated Burst, Symbol Length of 59, Coding Type RS-CC, Coding Rate Type 2/3, PAR = 9.8 dB @ 0.01 % Probability on CCDF

**Typical EVM and Drain Efficiency vs Output Power of CGH55030F1 and CGH55030P1 in CGH55030-AMP at 5.50GHz, 5.65 GHz, 5.80GHz, 802.16-2004 OFDM, PAR=9.8 dB**

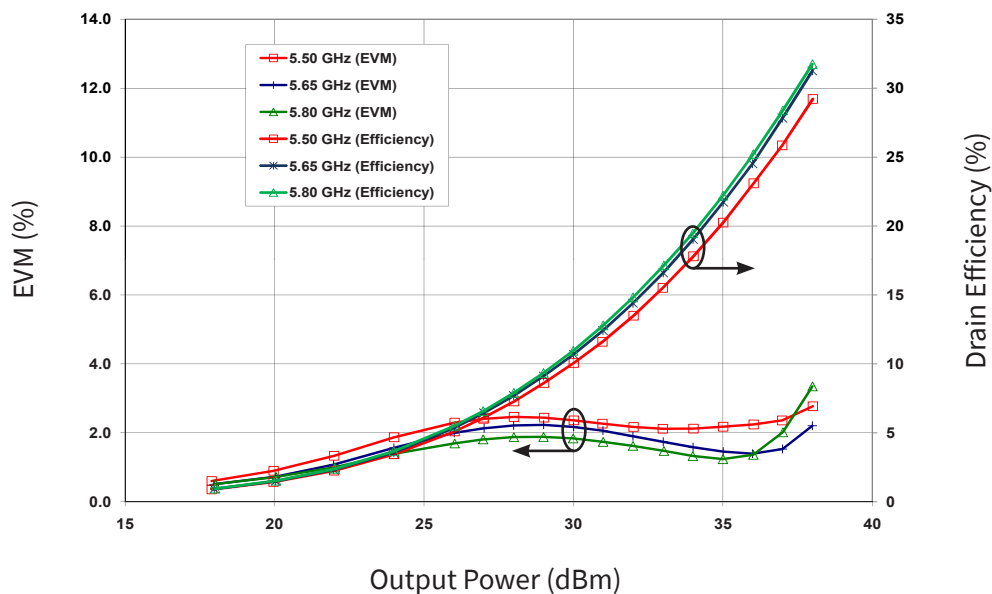

Note:  
 Under 802.16 OFDM, 3.5 MHz Channel BW, 1/4 Cyclic Prefix, 64 QAM Modulated Burst, Symbol Length of 59, Coding Type RS-CC, Coding Rate Type 2/3, PAR = 9.8 dB @ 0.01 % Probability on CCDF.



Typical DOCSIS Performance

**Modulation Error Ratio vs Output Power of CGH55030F1 and CGH55030P1 in Broadband Amplifier Circuit**

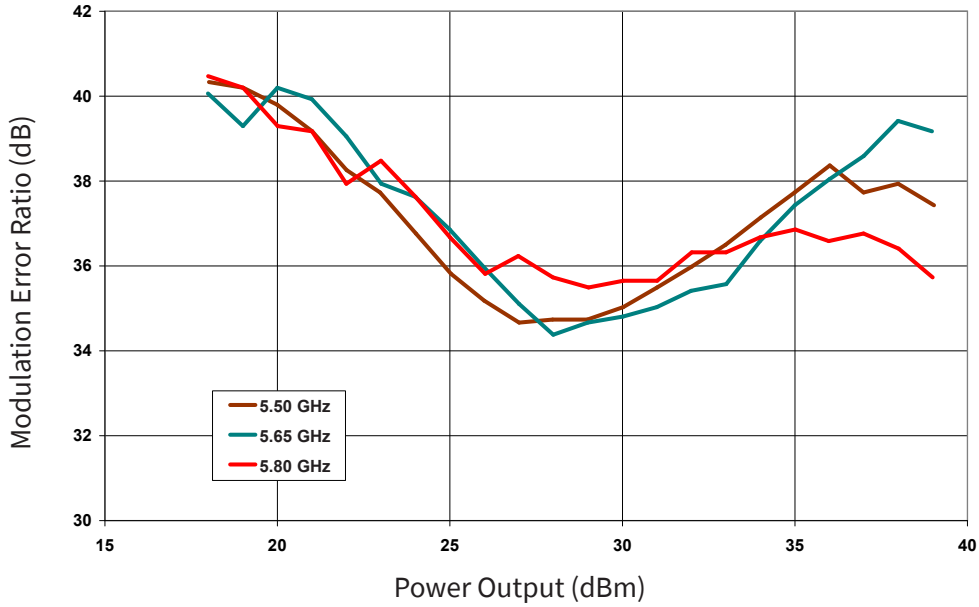

Note:

MER is the metric of choice for cable systems and can be related to EVM by the following equation:  $EVM(\%) = 100 \times 10^{-((MER_{dB} + MTAdB)/20)}$ . MTA is the "maximum-to-average constellation power ratio" which varies with the modulation type: MTA = 0 for BPSK and QPSK; 2.55 for 16QAM and 8QAM-DS; 3.68 for 64QAM and 32QAM-DS; 4.23 for 256QAM and 128QAM-DS

**EVM vs Output Power of CGH55030F1 and CGH55030P1 in Broadband Amplifier Circuit**

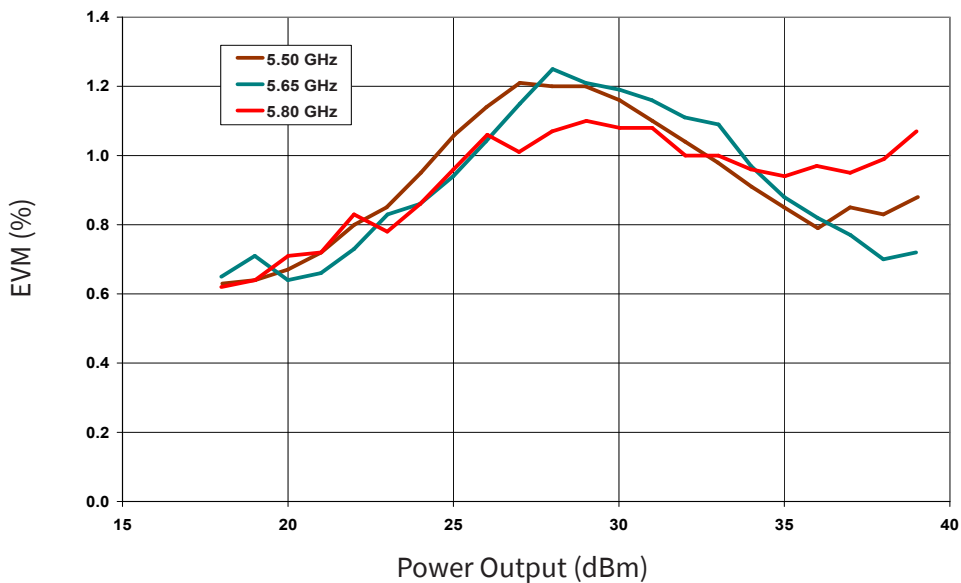

Note:

Under DOCSIS, 6.0 MHz Channel BW, 64 QAM, PN23, Filter Alpha 0.18, PAR = 6.7dB



**Typical Performance**

**Simulated Maximum Available Gain and K Factor of the CGH55030F1/P1**  
 $V_{DD} = 28\text{ V}, I_{DQ} = 250\text{ mA}$

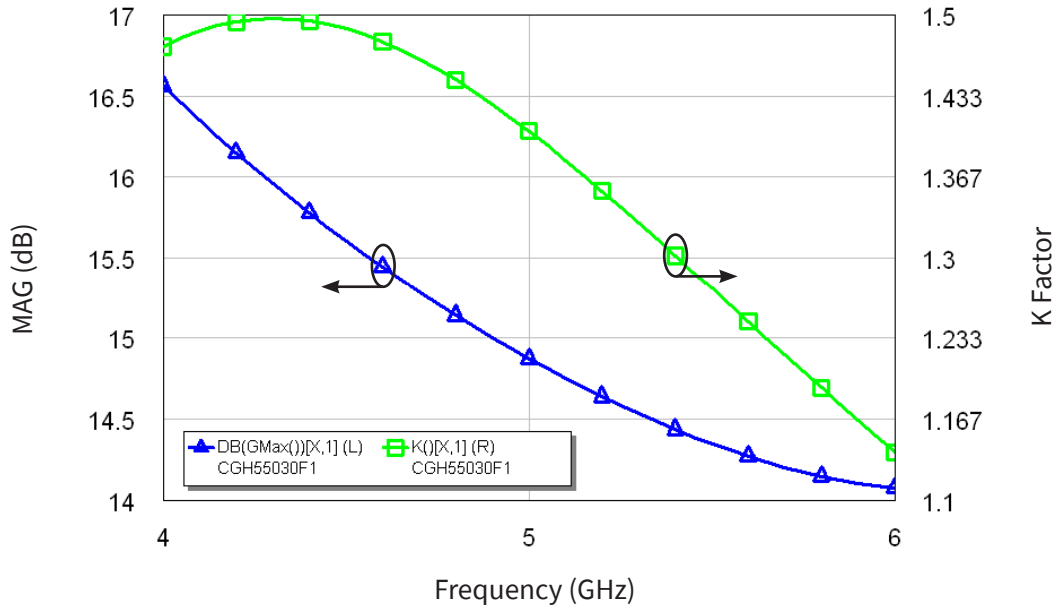

**Typical Noise Performance**

**Simulated Minimum Noise Figure and Noise Resistance vs Frequency of the CGH55030F1/P1**  
 $V_{DD} = 28\text{ V}, I_{DQ} = 250\text{ mA}$

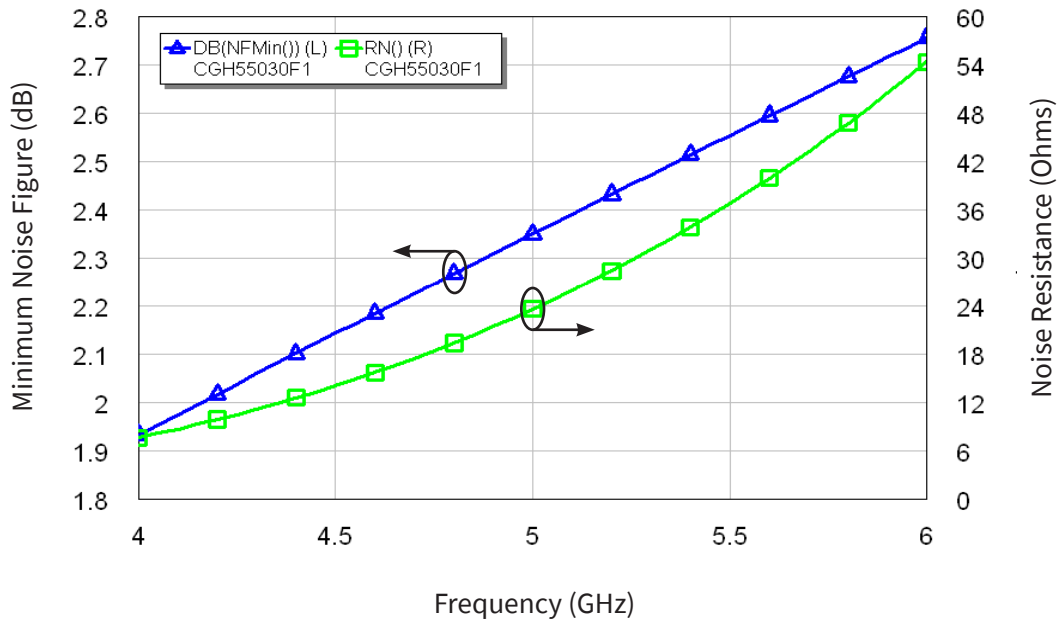



**Source and Load Impedances**

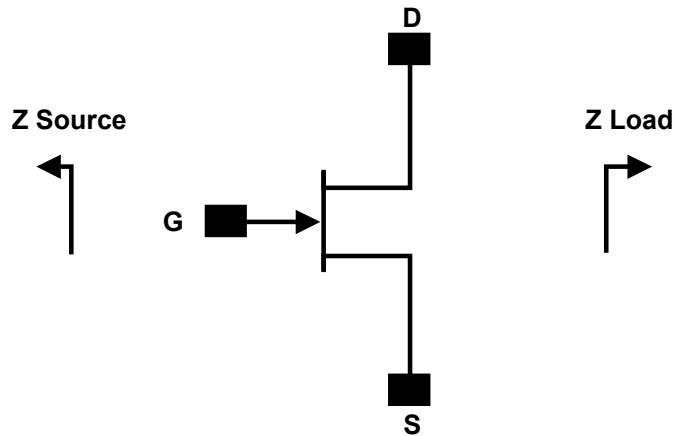

Frequency	Z Source	Z Load
5500	8.0 - j12.4	14.1 - j12.6
5650	8.7 - j13.1	14.7 - j11.7
5800	8.4 - j14.0	15.4 - j11.0

Note 1.  $V_{DD} = 28V$ ,  $I_{DQ} = 250$  mA in the 440166 package  
 Note 2. Impedances are extracted from the CGH55030-AMP demonstration amplifier and are not source and load pull data derived from the transistor

**Electrostatic Discharge (ESD) Classifications**

Parameter	Symbol	Class	Test Methodology
Human Body Model	HBM	1A (> 250 V)	JEDEC JESD22 A114-D
Charge Device Model	CDM	II ( 200 V - 500V)	JEDEC JESD22 C101-C

Note 1. Area exceeds Maximum Case Operating Temperature (See Page 2).



## CGH55030-AMP Demonstration Amplifier Circuit Bill of Materials

Designator	Description	Qty
R1	RES, 1/16W, 0603, 1%, 562 OHMS	1
R2	RES, 1/16W, 0603, 1%, 22.6 OHMS	1
C2	CAP, 0.3pF, +/-0.05pF, 0402, ATC600L	1
C16	CAP, 33 UF, 20%, G CASE	1
C15	CAP, 1.0UF, 100V, 10%, X7R, 1210	1
C8	CAP 10UF 16V TANTALUM	1
C9	CAP, 0.4pF, +/-0.05pF, 0603, ATC600S	1
C1	CAP, 1.2pF, +/-0.1pF, 0603, ATC600S	1
C6, C13	CAP,200 PF,0603 PKG, 100 V	2
C4, C11	CAP, 10.0pF,+/-5%, 0603, ATC600S	2
C5, C12	CAP, 39pF, +/-5%, 0603, ATC600S	2
C7, C14	CAP, 330000PF, 0805, 100V, TEMP STABILIZ	2
J3, J4	CONN, SMA, PANEL MOUNT JACK, FLANGE	2
J1	HEADER RT>PLZ .1CEN LK 5POS	1
-	PCB, RO4350B, Er = 3.48, h = 20 mil	1
-	CGH55030	1

## CGH55030-AMP Demonstration Amplifier Circuit

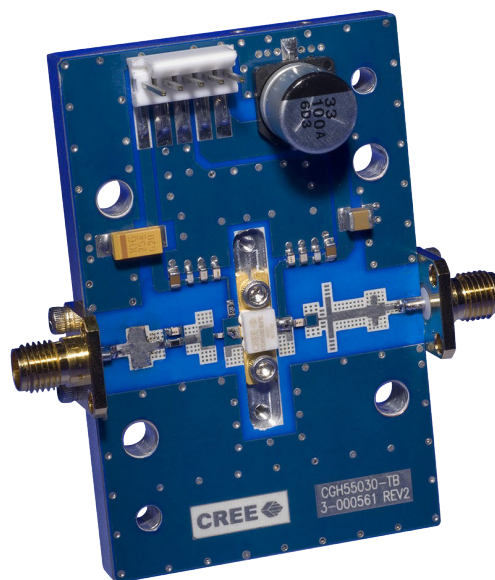



**CGH55030-AMP Demonstration Amplifier Circuit Schematic**

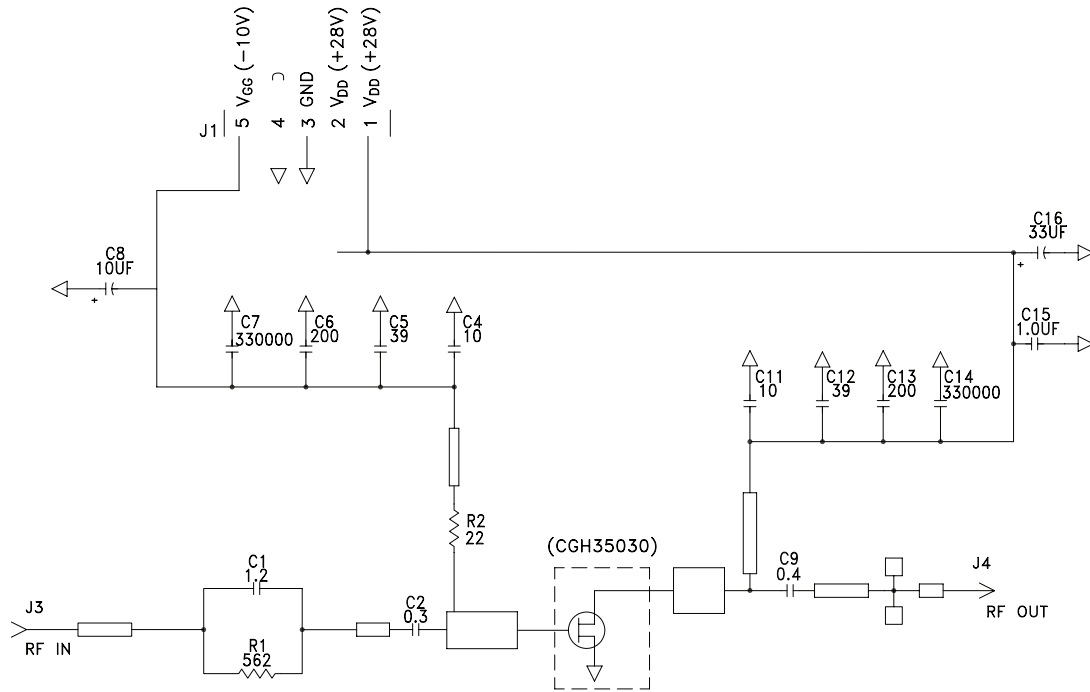

**CGH55030-AMP Demonstration Amplifier Circuit Outline**

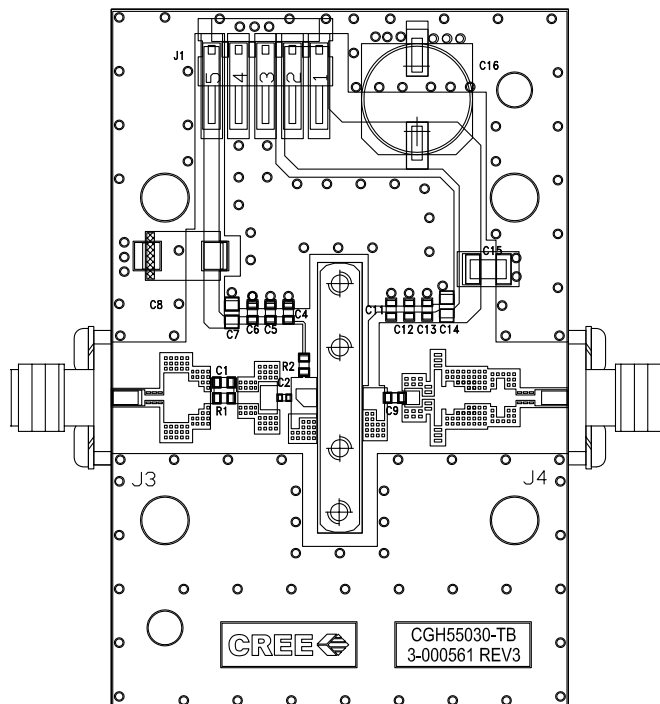

**Typical Package S-Parameters for CGH55030F1 and CGH55030P1**  
 (Small Signal,  $V_{DS} = 28\text{ V}$ ,  $I_{DQ} = 250\text{ mA}$ , angle in degrees)

Frequency	Mag S11	Ang S11	Mag S21	Ang S21	Mag S12	Ang S12	Mag S22	Ang S22
500 MHz	0.917	-157.22	12.62	91.45	0.018	7.56	0.458	-158.97
600 MHz	0.916	-161.92	10.57	87.33	0.018	4.70	0.465	-160.93
700 MHz	0.916	-165.46	9.07	83.78	0.018	2.41	0.472	-162.19
800 MHz	0.916	-168.28	7.94	80.58	0.018	0.51	0.478	-163.04
900 MHz	0.916	-170.61	7.05	77.64	0.017	-1.12	0.485	-163.64
1.0 GHz	0.916	-172.60	6.33	74.88	0.017	-2.55	0.493	-164.09
1.2 GHz	0.917	-175.88	5.24	69.73	0.017	-4.94	0.508	-164.77
1.4 GHz	0.918	-178.57	4.46	64.94	0.017	-6.84	0.525	-165.36
1.6 GHz	0.919	179.09	3.87	60.41	0.016	-8.31	0.542	-165.99
1.8 GHz	0.921	176.98	3.40	56.07	0.016	-9.39	0.559	-166.73
2.0 GHz	0.922	175.03	3.03	51.90	0.015	-10.06	0.577	-167.59
2.2 GHz	0.924	173.17	2.73	47.87	0.014	-10.31	0.594	-168.57
2.4 GHz	0.925	171.39	2.47	43.97	0.014	-10.12	0.610	-169.67
2.6 GHz	0.926	169.65	2.26	40.19	0.013	-9.46	0.626	-170.88
2.8 GHz	0.928	167.93	2.08	36.52	0.013	-8.31	0.642	-172.17
3.0 GHz	0.929	166.24	1.92	32.94	0.013	-6.65	0.656	-173.55
3.2 GHz	0.930	164.54	1.78	29.45	0.012	-4.49	0.670	-175.00
3.4 GHz	0.931	162.85	1.66	26.05	0.012	-1.85	0.683	-176.50
3.6 GHz	0.932	161.14	1.55	22.72	0.012	1.19	0.695	-178.06
3.8 GHz	0.933	159.42	1.46	19.46	0.012	4.55	0.706	-179.66
4.0 GHz	0.933	157.68	1.38	16.27	0.012	8.08	0.716	178.70
4.1 GHz	0.934	156.80	1.34	14.69	0.012	9.87	0.721	177.86
4.2 GHz	0.934	155.91	1.31	13.12	0.012	11.64	0.726	177.02
4.3 GHz	0.934	155.01	1.27	11.57	0.012	13.38	0.730	176.17
4.4 GHz	0.934	154.11	1.24	10.03	0.013	15.08	0.735	175.30
4.5 GHz	0.935	153.20	1.21	8.49	0.013	16.71	0.739	174.44
4.6 GHz	0.935	152.28	1.18	6.97	0.013	18.26	0.743	173.56
4.7 GHz	0.935	151.35	1.16	5.46	0.013	19.72	0.746	172.67
4.8 GHz	0.935	150.41	1.13	3.95	0.014	21.09	0.750	171.78
4.9 GHz	0.935	149.46	1.11	2.46	0.014	22.35	0.753	170.88
5.0 GHz	0.935	148.49	1.08	0.96	0.015	23.50	0.756	169.97
5.1 GHz	0.935	147.52	1.06	-0.52	0.015	24.55	0.760	169.05
5.2 GHz	0.935	146.53	1.04	-2.00	0.016	25.48	0.762	168.12
5.3 GHz	0.935	145.53	1.02	-3.48	0.016	26.30	0.765	167.18
5.4 GHz	0.935	144.52	1.00	-4.96	0.017	27.02	0.768	166.24
5.5 GHz	0.935	143.49	0.99	-6.43	0.018	27.62	0.770	165.28
5.6 GHz	0.935	142.45	0.97	-7.90	0.018	28.12	0.773	164.32
5.7 GHz	0.934	141.39	0.95	-9.37	0.019	28.53	0.775	163.35
5.8 GHz	0.934	140.31	0.94	-10.84	0.020	28.83	0.777	162.36
5.9 GHz	0.934	139.22	0.93	-12.32	0.020	29.05	0.779	161.37
6.0 GHz	0.934	138.12	0.91	-13.79	0.021	29.18	0.781	160.36

To download the s-parameters in s2p format, go to the [CGH55030F1/P1](#) Product page and click on the documentation tab.

**Product Dimensions CGH55030F1 (Package Type — 440166)**

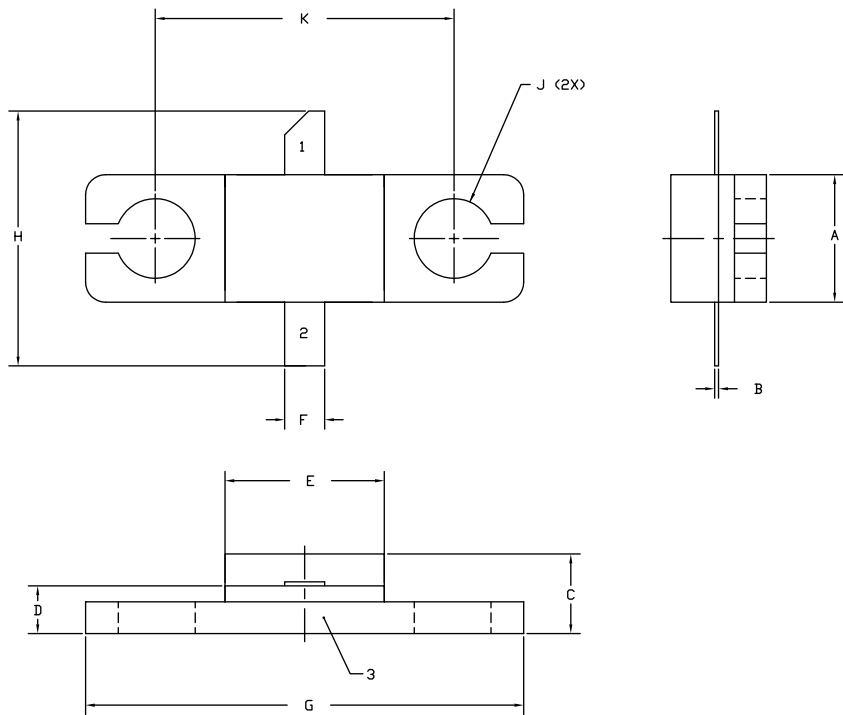

- NOTES:
1. DIMENSIONING AND TOLERANCING PER ANSI Y14.5M, 1982.
  2. CONTROLLING DIMENSION: INCH.
  3. ADHESIVE FROM LID MAY EXTEND A MAXIMUM OF 0.020" BEYOND EDGE OF LID.
  4. LID MAY BE MISALIGNED TO THE BODY OF THE PACKAGE BY A MAXIMUM OF 0.008" IN ANY DIRECTION.
  5. ALL PLATED SURFACES ARE NI/AU

DIM	INCHES		MILLIMETERS	
	MIN	MAX	MIN	MAX
A	0.155	0.165	3.94	4.19
B	0.004	0.006	0.10	0.15
C	0.115	0.135	2.92	3.43
D	0.057	0.067	1.45	1.70
E	0.195	0.205	4.95	5.21
F	0.045	0.055	1.14	1.40
G	0.545	0.555	13.84	14.09
H	0.280	0.360	7.11	9.14
J	Ø .100		2.54	
K	0.375		9.53	

PIN 1. GATE  
 PIN 2. DRAIN  
 PIN 3. SOURCE

**Product Dimensions CGH55030P1 (Package Type — 440196)**

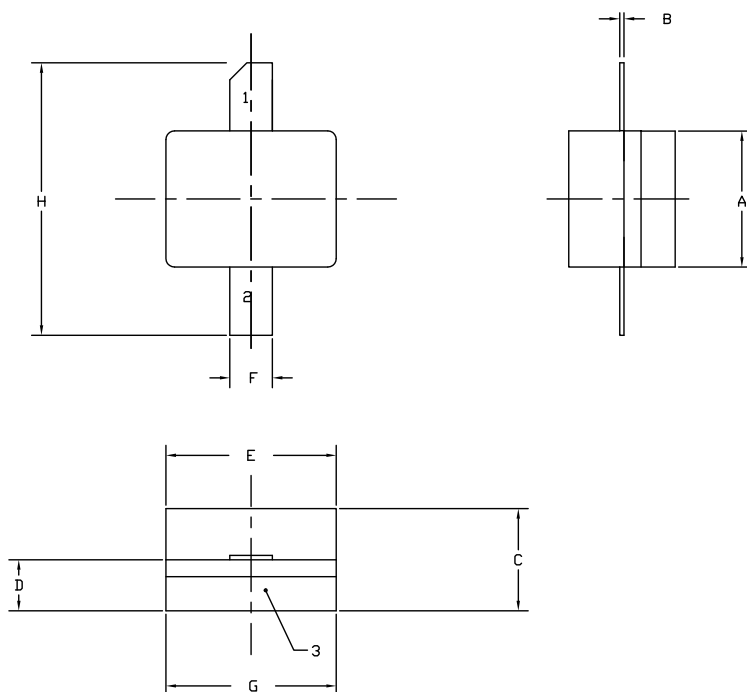

- NOTES:
1. DIMENSIONING AND TOLERANCING PER ANSI Y14.5M, 1982.
  2. CONTROLLING DIMENSION: INCH.
  3. ADHESIVE FROM LID MAY EXTEND A MAXIMUM OF 0.020" BEYOND EDGE OF LID.
  4. LID MAY BE MISALIGNED TO THE BODY OF THE PACKAGE BY A MAXIMUM OF 0.008" IN ANY DIRECTION.
  5. ALL PLATED SURFACES ARE NI/AU

DIM	INCHES		MILLIMETERS	
	MIN	MAX	MIN	MAX
A	0.155	0.165	3.94	4.19
B	0.003	0.006	0.10	0.15
C	0.115	0.135	2.92	3.17
D	0.057	0.067	1.45	1.70
E	0.195	0.205	4.95	5.21
F	0.045	0.055	1.14	1.40
G	0.195	0.205	4.95	5.21
H	0.280	0.360	7.11	9.14

PIN 1. GATE  
 PIN 2. DRAIN  
 PIN 3. SOURCE



**Product Ordering Information**

Order Number	Description	Unit of Measure	Image
CGH55030F1	GaN HEMT	Each	
CGH55030P1	GaN HEMT	Each	
CGH55030F1-AMP	Test board with GaN HEMT installed	Each	



For more information, please contact:

4600 Silicon Drive  
Durham, North Carolina, USA 27703  
[www.wolfspeed.com/RF](http://www.wolfspeed.com/RF)

Sales Contact  
[RFSales@cree.com](mailto:RFSales@cree.com)

## Notes

---

### Disclaimer

Specifications are subject to change without notice. “Typical” parameters are the average values expected by Cree in large quantities and are provided for information purposes only. Cree products are not warranted or authorized for use as critical components in medical, life-saving, or life-sustaining applications, or other applications where a failure would reasonably be expected to cause severe personal injury or death. No responsibility is assumed by Cree for any infringement of patents or other rights of third parties which may result from use of the information contained herein. No license is granted by implication or otherwise under any patent or patent rights of Cree.