

# SMD Power Inductor CDRH10D68



## Description

- Ferrite drum core construction.
- Magnetically shielded.
- L × W × H: 10.5 × 10.5 × 7.1 mm Max.
- Product weight: 2.6g(Ref.)
- Moisture Sensitivity Level: 1
- RoHS compliance.

## Environmental Data

- Operating temperature range: -40°C ~ +105°C (including coil's self temperature rise)
- Storage temperature range: -40°C ~ +105°C
- Solder reflow temperature: 260 °C peak.

## Packaging

- Carrier tape and reel packaging
- 12.9" diameter reel
- 500pcs per reel

## Applications

- Ideally Used in Notebook PC, DSC/DVC, Game Machine, etc as DC-DC converter inductors.

## Dimension - [mm]

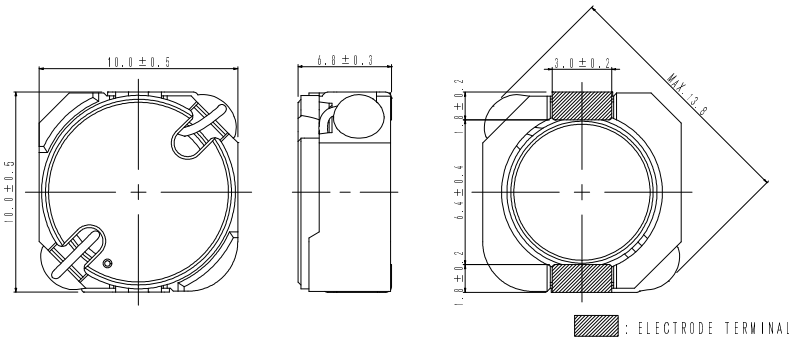

## Land pattern and Schematics - [mm]

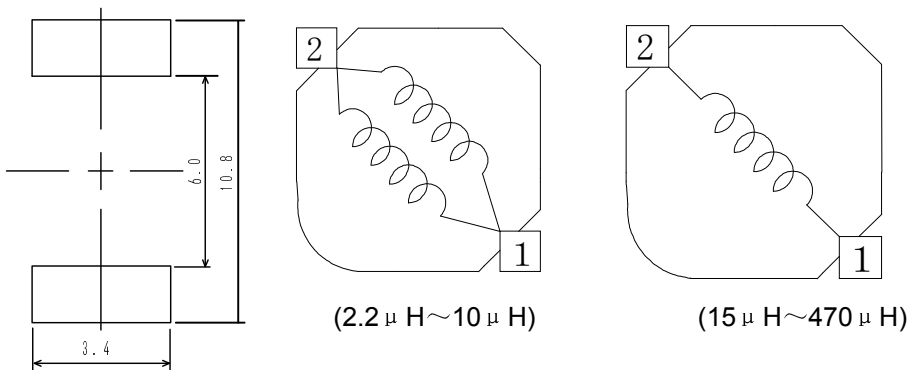

# SMD Power Inductor CDRH10D68



## Electrical Characteristics

Part Name	Stamp	Inductance ( $\mu$ H) [ within ] ※1	D.C.R. (m $\Omega$ ) Max. (Typ.) (at 20°C)	Saturation Current (A) ※2		Temperature Rise Current (A) ※3
				at 20°C	at 105°C	
CDRH10D68NP-2R2NC	2R2	2.2 $\pm$ 25%	7.20(5.7)	9.8	8.0	9.0
CDRH10D68NP-3R3NC	3R3	3.3 $\pm$ 25%	8.50(6.8)	8.4	6.8	8.0
CDRH10D68NP-4R7NC	4R7	4.7 $\pm$ 25%	9.80(7.9)	7.9	6.5	7.0
CDRH10D68NP-6R0NC	6R0	6.0 $\pm$ 25%	14.0(11.2)	6.5	5.2	5.5
CDRH10D68NP-8R2NC	8R2	8.2 $\pm$ 25%	15.8(12.7)	5.1	4.0	5.3
CDRH10D68NP-100MC	100	10 $\pm$ 20%	21.5(17.2)	4.8	3.8	4.4
CDRH10D68NP-150MC	150	15 $\pm$ 20%	34.5(27.6)	4.5	3.6	3.6
CDRH10D68NP-180MC	180	18 $\pm$ 20%	37.0(29.7)	3.6	2.9	3.4
CDRH10D68NP-220MC	220	22 $\pm$ 20%	40.2(32.1)	3.0	2.6	3.2
CDRH10D68NP-330MC	330	33 $\pm$ 20%	60.4(48.3)	2.7	2.2	2.6
CDRH10D68NP-470MC	470	47 $\pm$ 20%	106.3(85.0)	2.4	2.0	2.1
CDRH10D68NP-680MC	680	68 $\pm$ 20%	149.8(119.8)	2.0	1.6	1.7
CDRH10D68NP-820MC	820	82 $\pm$ 20%	163.3(130.6)	1.7	1.4	1.6
CDRH10D68NP-101MC	101	100 $\pm$ 20%	205.0(164.3)	1.5	1.2	1.5
CDRH10D68NP-151MC	151	150 $\pm$ 20%	291.9(233.5)	1.3	1.1	1.3
CDRH10D68NP-181MC	181	180 $\pm$ 20%	325.7(260.6)	1.2	0.9	1.2
CDRH10D68NP-221MC	221	220 $\pm$ 20%	362.4(290.0)	1.0	0.8	1.1
CDRH10D68NP-331MC	331	330 $\pm$ 20%	525.1(420.1)	0.8	0.6	0.9
CDRH10D68NP-471MC	471	470 $\pm$ 20%	739.6(591.7)	0.7	0.5	0.8

※1 Inductance measuring condition: at 100kHz.

※2 The saturation current: This indicates the value of DC current when the inductance decreases to 65% of its nominal.

※3 The temperature rise: The value of DC current when the temperature rise is  $\Delta T=40^{\circ}\text{C}$  ( $T_a=20^{\circ}\text{C}$ ).

# SMD Power Inductor CDRH10D68

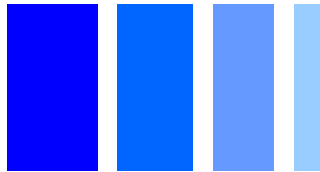

## Saturation Current & Temperature Rise Graph

— L (20°C) — L (100°C) —  $\Delta T$

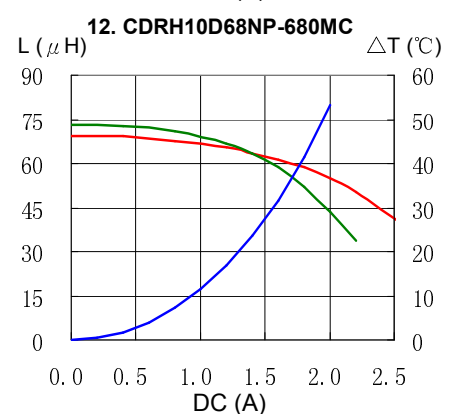
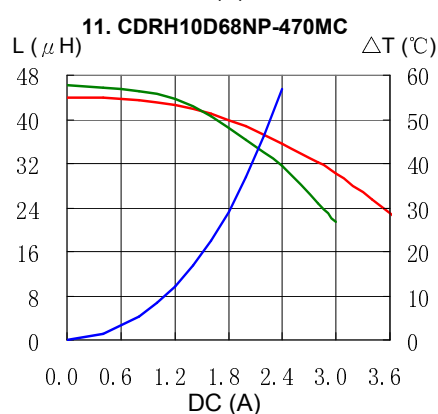
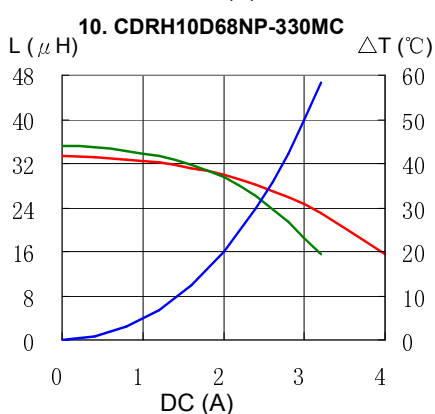
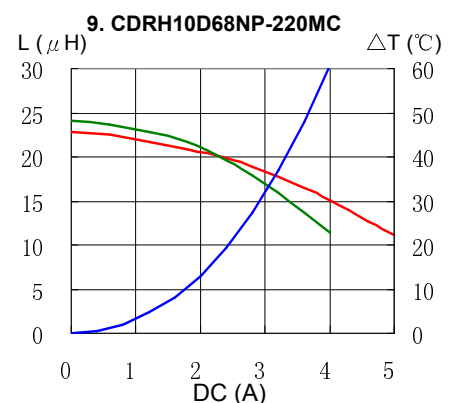
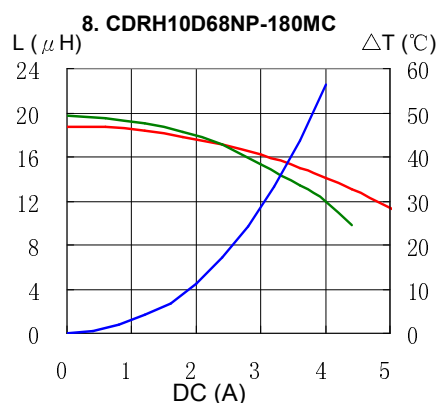
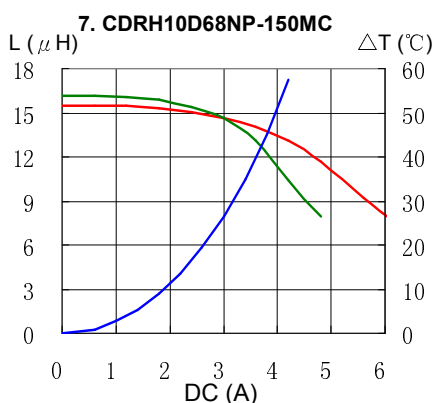
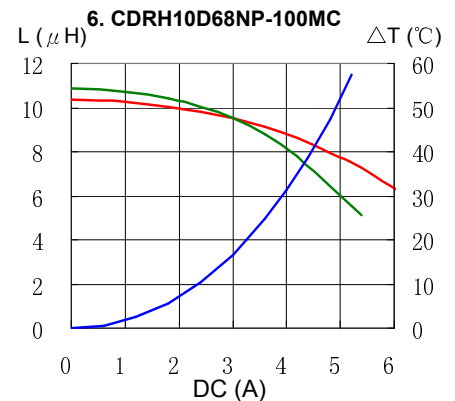
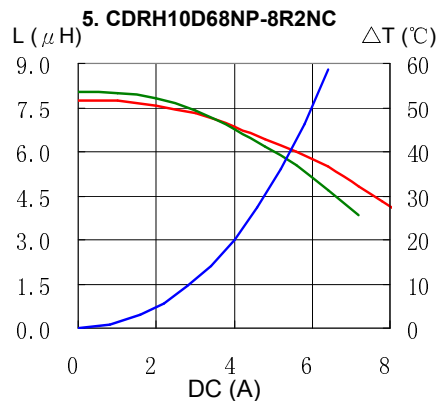
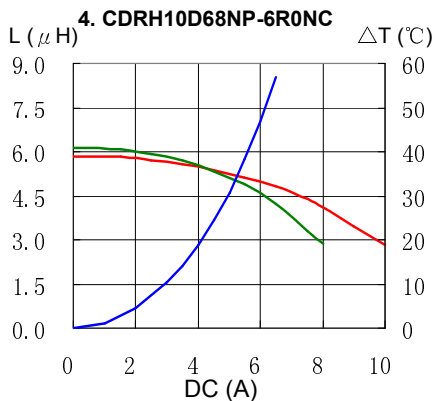
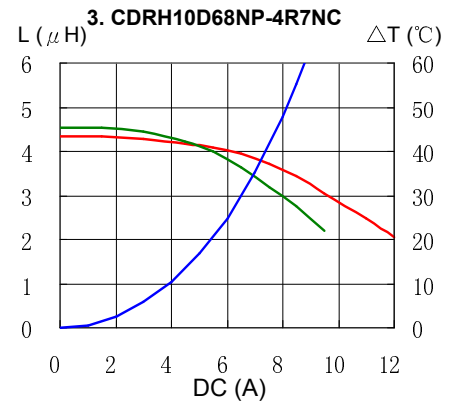
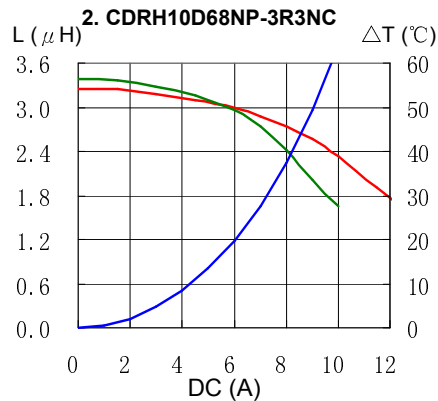
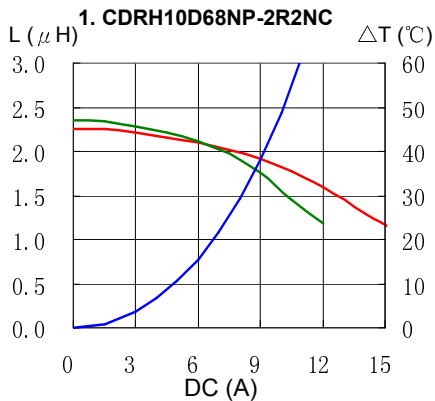

# SMD Power Inductor CDRH10D68



## Saturation Current & Temperature Rise Graph

— L (20°C) — L (100°C) —  $\Delta T$

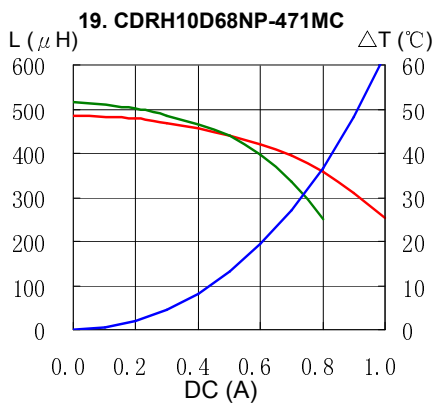
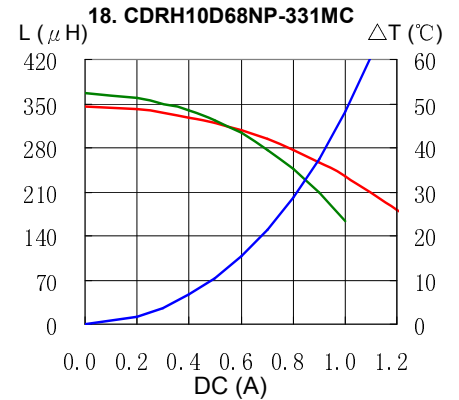
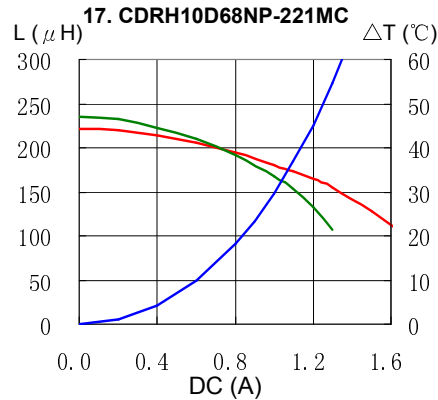
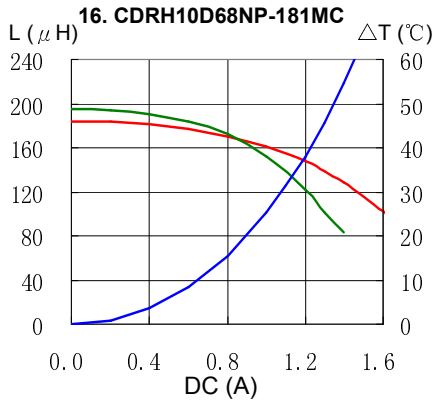
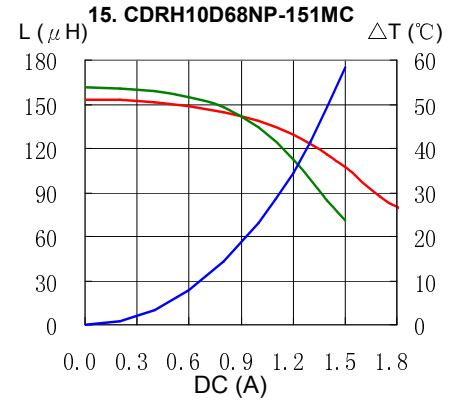
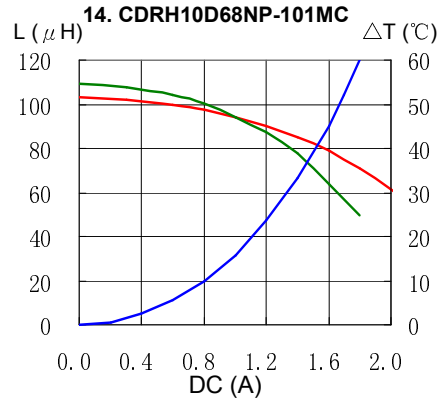
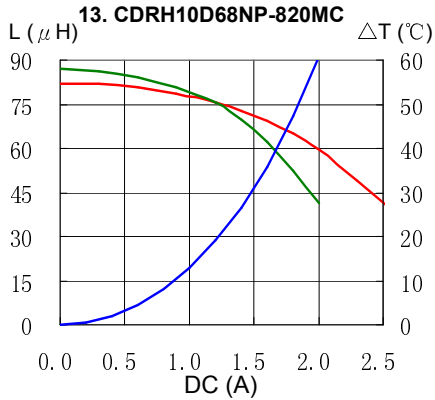

# SMD Power Inductor CDRH10D68



## Solder Reflow Condition

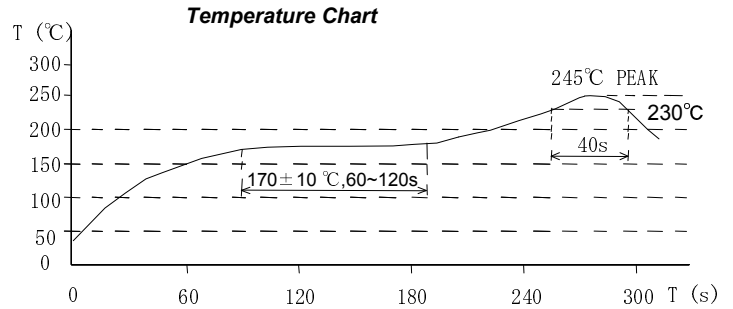
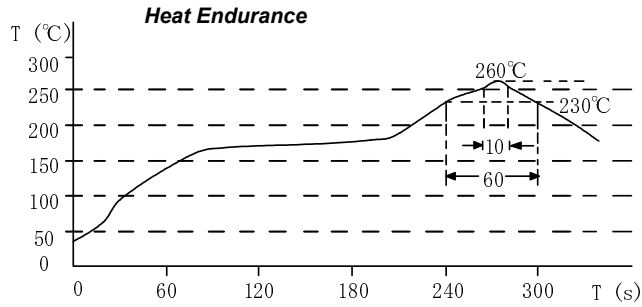

Please refer to the sales offices on our website - <http://www.sumida.com>

### Hong Kong

Tel. +852-2880-6688  
FAX. +852-2565-9600  
[sales@hk.sumida.com](mailto:sales@hk.sumida.com)

### Tokyo

Tel. +81-3-5202-7112  
FAX. +81-3-5202-7105  
[sales@jp.sumida.com](mailto:sales@jp.sumida.com)

### Chicago

Tel. +1-847-545-6700  
FAX. +1-847-545-6720  
[sales@us.sumida.com](mailto:sales@us.sumida.com)

### Shanghai

Tel. +86-021-5836-3299  
FAX. +86-021-5836-3266  
[shanghai.sales@cn.sumida.com](mailto:shanghai.sales@cn.sumida.com)

### Seoul

Tel. +82-2-6237-0777  
FAX. +82-2-6237-0778  
[sales@kr.sumida.com](mailto:sales@kr.sumida.com)

### Oberzell

Tel. +49-8591-937-0  
FAX. +49-8591-937-103  
[contact@sumida-eu.com](mailto:contact@sumida-eu.com)

### Shenzhen

Tel. +86-755-8291-0228  
FAX. +86-755-8291-0338  
[shenzhen.sales@cn.sumida.com](mailto:shenzhen.sales@cn.sumida.com)

### Singapore

Tel. +65-6296-3388  
FAX. +65-6296-3390  
[sales@sg.sumida.com](mailto:sales@sg.sumida.com)

### Neumarkt

Tel. +49-9181-4509-110  
FAX. +49-9181-4509-310  
[infocomp@eu.sumida.com](mailto:infocomp@eu.sumida.com)

### Taipei

Tel. +886-2-8751-2737  
FAX. +886-2-8751-2738  
[sales@tw.sumida.com](mailto:sales@tw.sumida.com)

### San Jose

Tel. +1-408-321-9660  
FAX. +1-408-321-9308  
[sales@us.sumida.com](mailto:sales@us.sumida.com)