

Part No. CC0201JRNPO9BN390

| 0201 (0603) | NPO | 50 Vdc | 39 pF | ±5% |

Surface-Mount Ceramic Multilayer Capacitors (RoHS compliant & Halogen Free)

■ Appearance

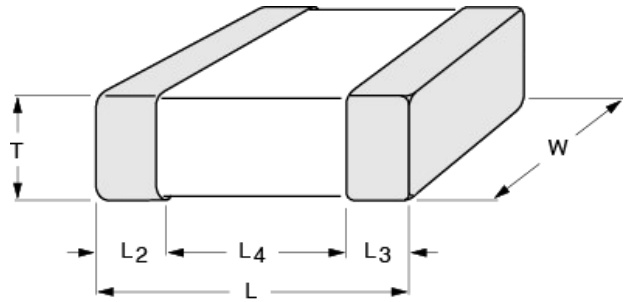

■ Dimension (mm)

L (Length)	0.60 ±0.03
W (width)	0.30 ±0.03
T (Thickness)	0.30 ±0.03
L2/L3	0.10~0.20
L4	0.2

■ Specification

Application	General Purpose
Case Size (EIA/JIS)	0201 (0603)
Temperature Characteristic	NPO
Operation Temp. Range	-55 to +125°C
Capacitance	39 pF
Capacitance Tolerance	±5%
Rated Voltage (VDC)	50
Endurance (% Rated voltage)	200%
Tanδ (max)	0.10%
Insulation Resistance (min)	10.0 GΩ
Packing	Paper/PE Tape Reel 7 inch
Standard Packing Qty (pcs)	15,000
Test Method	IEC-60384

The data are for reference only. Electrical characteristics vary depending on environment or measurement condition.

YAGEO reserves the right to make change to the data at any time without notice. Before making final selection, please check product specification.

Part No. CC0201JRNPO9BN390

| 0201 (0603) | NPO | 50 Vdc | 39 pF | ±5% |

Surface-Mount Ceramic Multilayer Capacitors (RoHS compliant & Halogen Free)

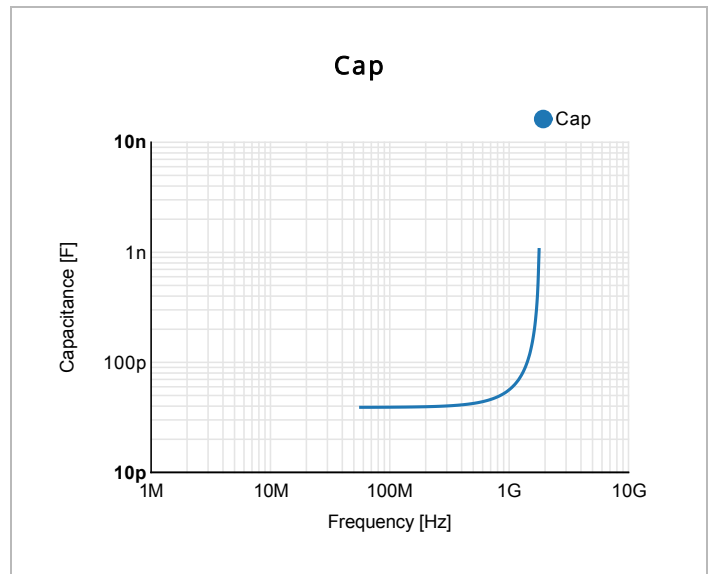
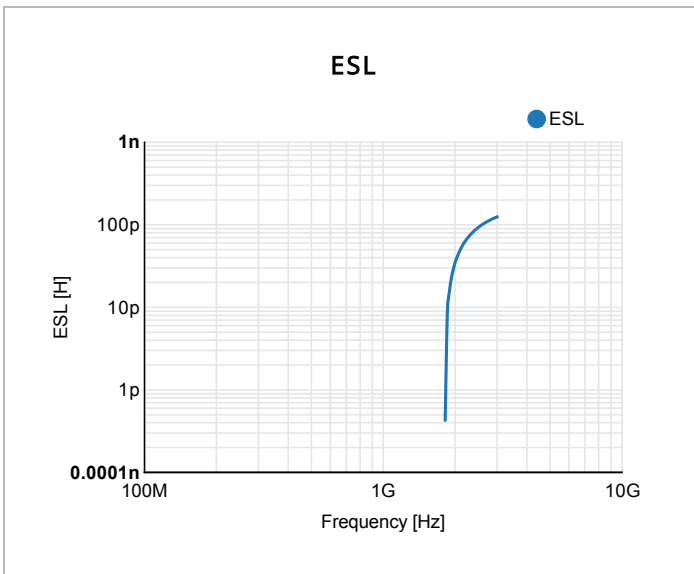
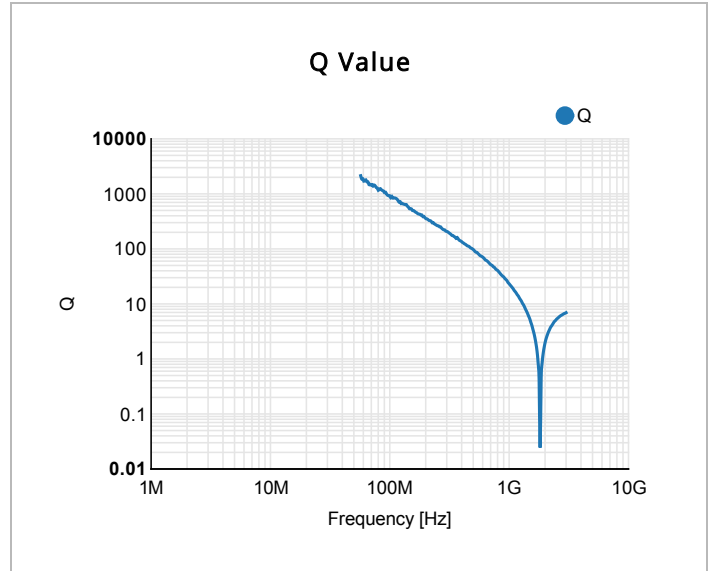
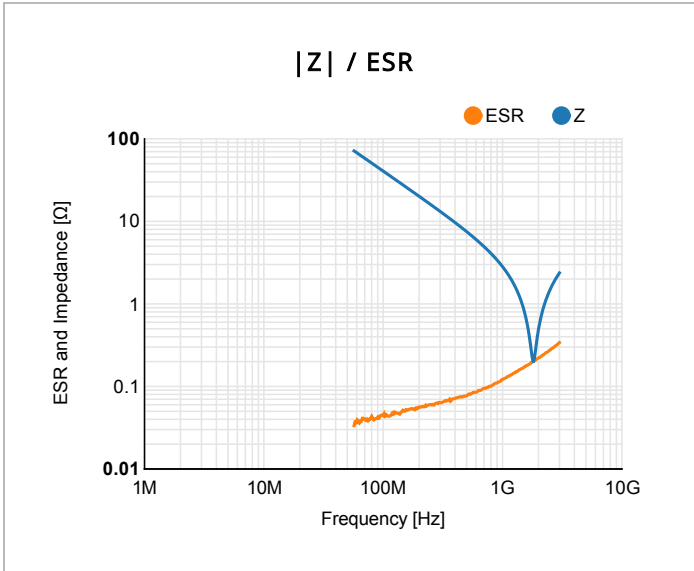

The data are for reference only. Electrical characteristics vary depending on environment or measurement condition. YAGEO reserves the right to make change to the data at any time without notice. Before making final selection, please check product specification.

Part No. CC0201JRNPO9BN390

| 0201 (0603) | NPO | 50 Vdc | 39 pF | ±5% |

Surface-Mount Ceramic Multilayer Capacitors (RoHS compliant & Halogen Free)

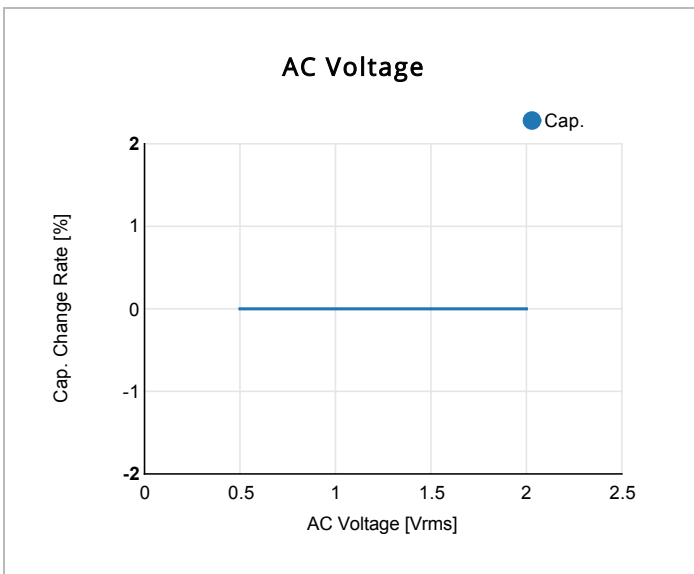
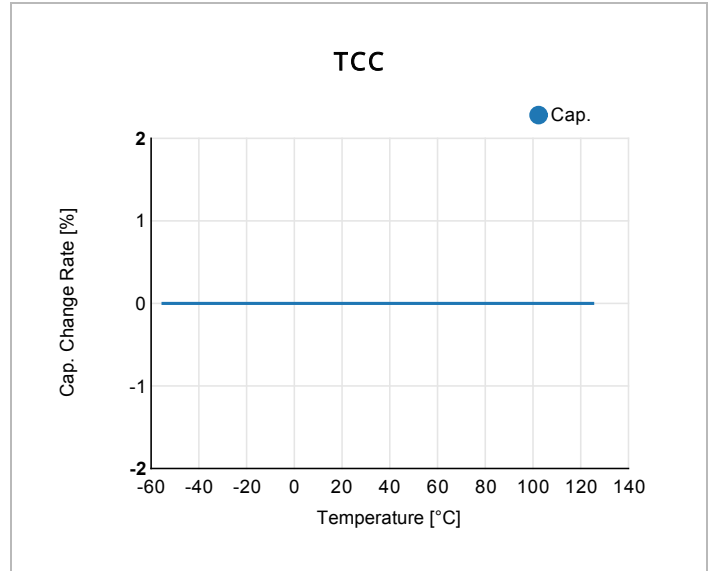
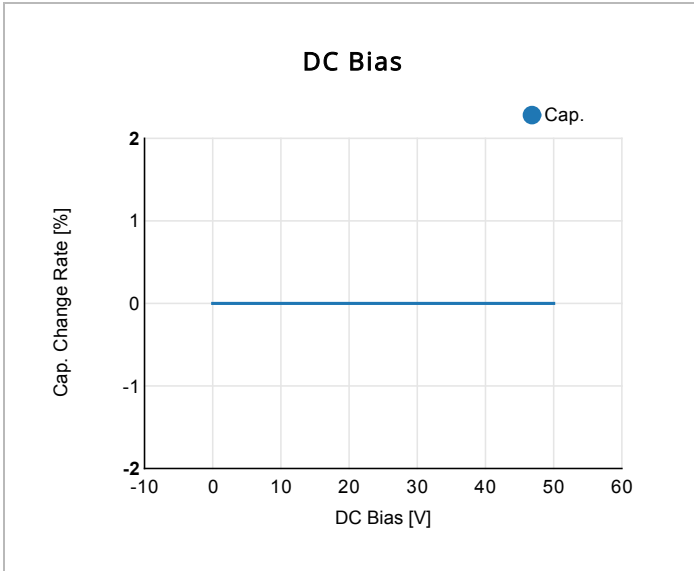

The data are for reference only. Electrical characteristics vary depending on environment or measurement condition.

YAGEO reserves the right to make change to the data at any time without notice. Before making final selection, please check product specification.

