

## EMERALD-MAXI-A

Asymmetric beam. Assembly with installation tape.

### TECHNICAL SPECIFICATIONS:

Dimensions	33 x 25 mm
Height	12.2 mm
Fastening	tape, pin
Colour	clear
Box size	480 x 280 x 300 mm
Box weight	7.8 kg
Quantity in Box	1330 pcs
ROHS compliant	yes ⓘ



### MATERIAL SPECIFICATIONS:

Component	Type	Material	Colour
EMERALD-MAXI-A	Lens	PMMA	clear
ROSE-TAPE	Tape	PU tape	black

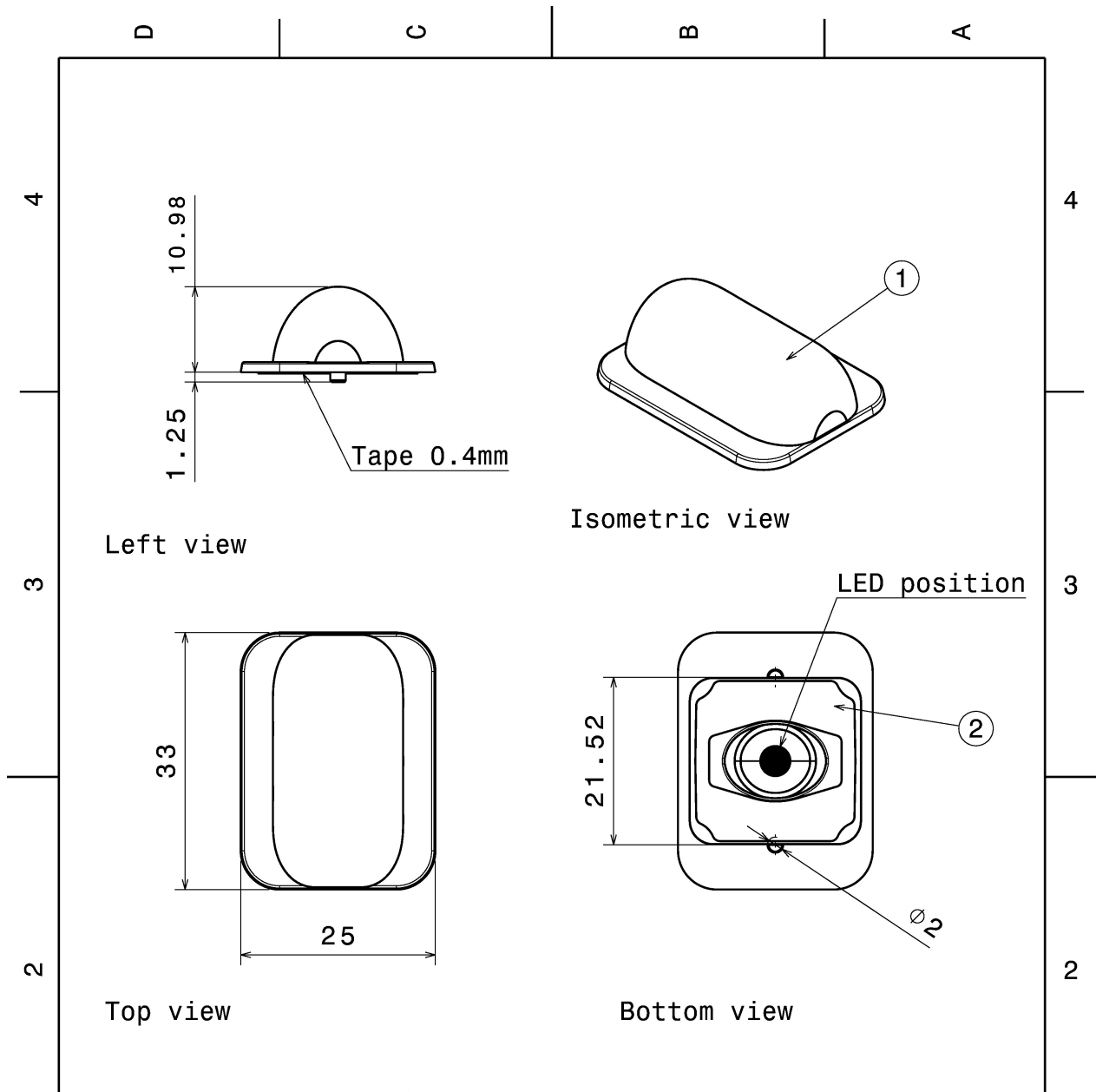

INDEX	PART NO	DESCRIPTION	MATERIAL	COLOUR
1	C14522	EMERALD-MAXI-A	PMMA	clear
2	-	ROSE-TAPE	PU foam	black

Tolerances if not otherwise shown  
According to DIN ISO 2768-1  
Linear measures: class C  
According to DIN ISO 2768-2  
Form and position: class L

**LEDiL** LediL Oy  
Salorankatu 10  
FIN 24240 SALO  
Finland

THIRD ANGLE PROJECTION:

DRAWING TITLE  
**CA14523\_EMERALD-MAXI-A**

This drawing is the property of LEDiL Oy. It may not be reproduced, copied or communicated without a written agreement with LEDiL Oy.

SIZE	PART NUMBER
A4	CA14523

SCALE	3:2	WEIGHT	4,6 g	SHEET	1/1
-------	-----	--------	-------	-------	-----

#### PHOTOMETRIC DATA (MEASURED):



LED XM-L  
FWHM Asymmetric  
Efficiency 92 %  
Peak intensity 2.000 cd/lm  
Required components:

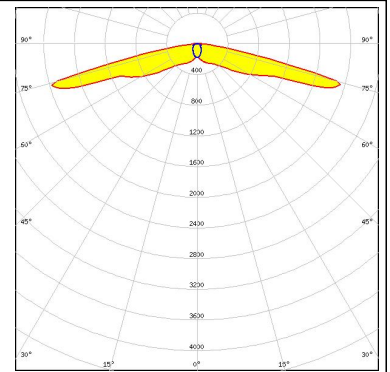

LED XM-L2  
FWHM Asymmetric  
Efficiency 93 %  
Peak intensity 1.900 cd/lm  
Required components:

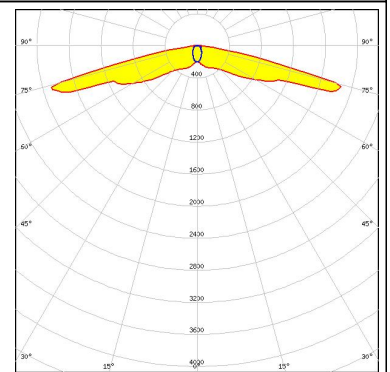

LED XP-L HI  
FWHM Asymmetric  
Efficiency 92 %  
Peak intensity 3.400 cd/lm  
Required components:



LED LUXEON M/MX  
FWHM Asymmetric  
Efficiency 92 %  
Peak intensity 1.200 cd/lm  
Required components:

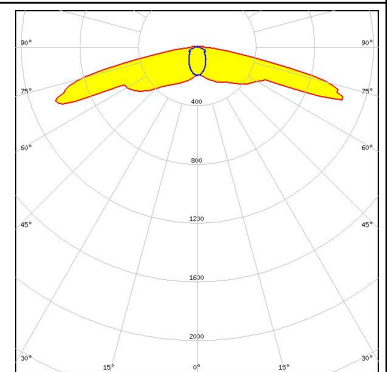

#### PHOTOMETRIC DATA (MEASURED):



LED LUXEON MZ  
FWHM Asymmetric  
Efficiency 92 %  
Peak intensity 2.100 cd/lm  
Required components:

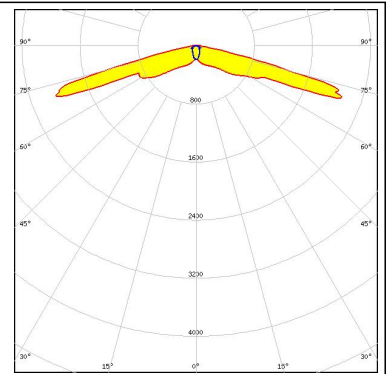

LED Oslon Black Flat  
FWHM Asymmetric  
Efficiency 93 %  
Peak intensity 6.800 cd/lm  
Required components:

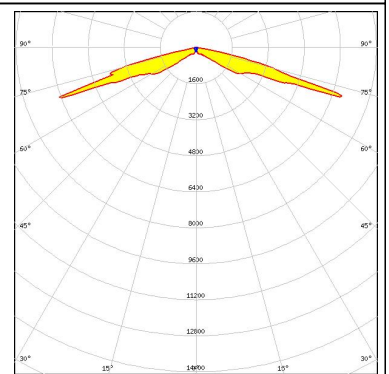

#### PHOTOMETRIC DATA (SIMULATED):

**OSRAM**  
Opto Semiconductors

LED                    OSCONIQ P 7070  
FWHM                Asymmetric  
Efficiency            86 %  
Peak intensity      1.320 cd/lm  
Required components:

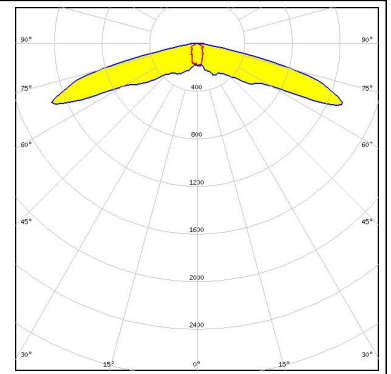

### GENERAL INFORMATION:

NOTE: The typical beam angle will be changed by different color, chip size and chip position tolerance. The typical total beam angle is the full angle measured where the luminous intensity is half of the peak value.

### MATERIALS:

As part of our continuous research and improvement processes, and to ensure the best possible quality and availability of our products, LEDiL reserves the right to change material grades without notice.

### PRODUCT DATA USER AGREEMENT AND DISCLAIMER:

The measured data in the provided downloadable LEDiL Product Datasheets and Mechanical 2D-Drawings is rounded and provided as reference for planning. LEDiL Oy's optical specifications have been verified by conducting performance testing of the products in accordance with the company's quality system. The reported data are averaged results of multiple measurements with typical variation. LEDiL Oy reserves the right to without prior notification make changes and improvements to its products.

LEDiL Oy assumes neither warranty, nor guarantee nor any other liability of any kind for the contents and correctness of the provided data. The provided data has been generated with highest diligence but the provided data may in reality not represent the complete possible variation range of all intrinsic parameters. Therefore, in certain cases a deviation from the provided data could occur.

LEDiL Oy reserves the right to undertake technical changes of its products without further notification which could lead to changes in the provided data. LEDiL Oy assumes no liability of any kind for the possible deviation from any provided data or any other damage resulting from the usage of the provided data.

The user agrees to this disclaimer and user agreement with the download or usage of the provided files.

#### LEDiL Oy

Joensuunkatu 13  
FI-24240 SALO  
Finland

#### LEDiL Inc.

228 West Page Street  
Suite D  
Sycamore IL 60178  
USA

#### Local sales and technical support

[www.ledil.com/  
where\\_to\\_buy](http://www.ledil.com/where_to_buy)

#### Shipping locations

Salo, Finland  
Hong Kong, China

#### Distribution Partners

[www.ledil.com/  
where\\_to\\_buy](http://www.ledil.com/where_to_buy)