

VERONICA-SQ-O

~55° 12° oval beam

TECHNICAL SPECIFICATIONS:

Dimensions	Ø 22.5 + 22.5 mm
Height	12.2 mm
Fastening	tape, pin
Colour	clear
Box size	480 x 280 x 300 mm
Box weight	8.2 kg
Quantity in Box	1980 pcs
ROHS compliant	yes ⓘ



MATERIAL SPECIFICATIONS:

Component	Type	Material	Colour
VERONICA-SQ-O	Lens	PMMA	clear
VERONICA-TAPE	Tape	PU tape	clear

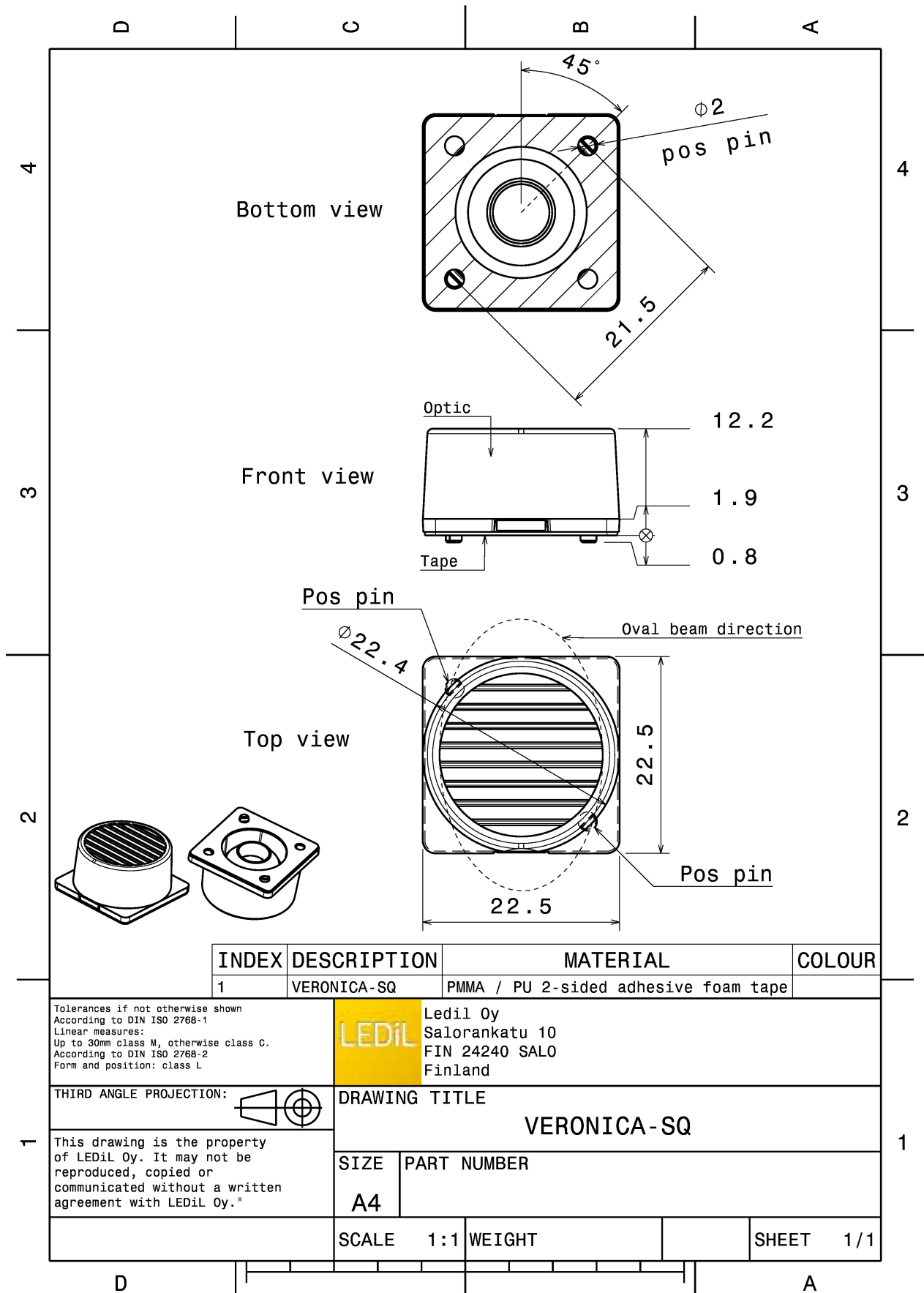

PHOTOMETRIC DATA (MEASURED):



LED XB-H
 FWHM 45.0 + 16.0°
 Efficiency 77 %
 Peak intensity 2.700 cd/lm
 Required components:

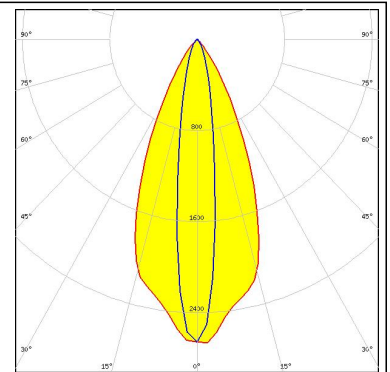
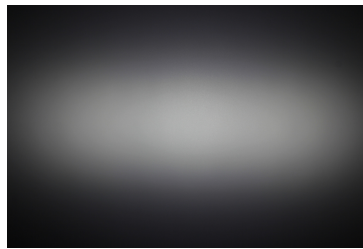

LED XD16
 FWHM 47.0 + 17.0°
 Efficiency 87 %
 Peak intensity 2.200 cd/lm
 Required components:

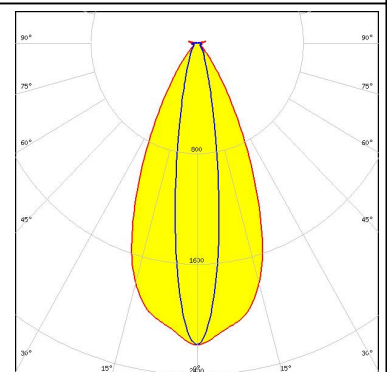
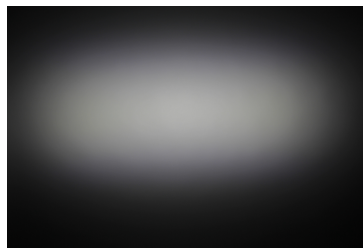

LED XHP35 HD
 FWHM 45.0 + 20.0°
 Efficiency 73 %
 Peak intensity 2.130 cd/lm
 Required components:

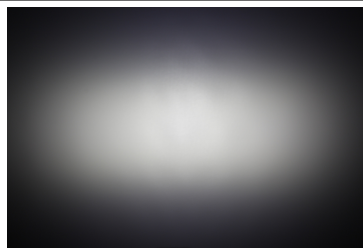

LED XHP35 HI
 FWHM 46.0 + 16.0°
 Efficiency 75 %
 Peak intensity 2.700 cd/lm
 Required components:

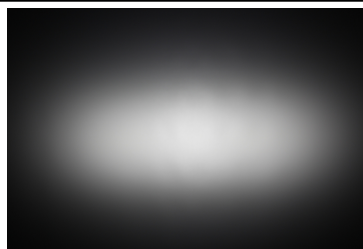

PHOTOMETRIC DATA (MEASURED):



LED XM-L
 FWHM 47.0 + 20.0°
 Efficiency 80 %
 Peak intensity 2.300 cd/lm
 Required components:

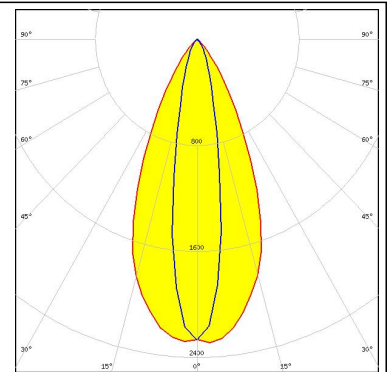

LED XM-L2
 FWHM 47.0 + 20.0°
 Efficiency 80 %
 Peak intensity 2.300 cd/lm
 Required components:

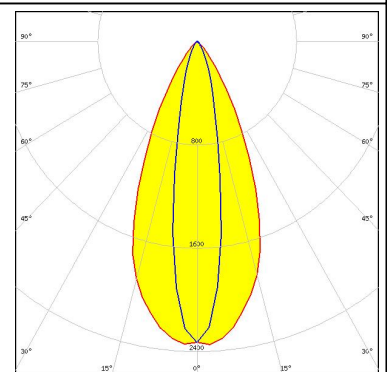
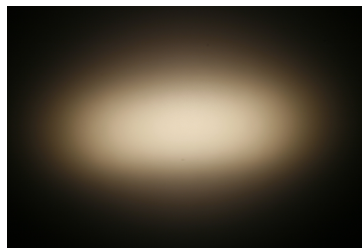

LED XP-E2
 FWHM 46.0 + 12.0°
 Efficiency 80 %
 Peak intensity 3.500 cd/lm
 Required components:

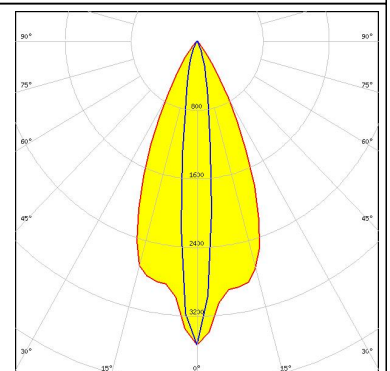
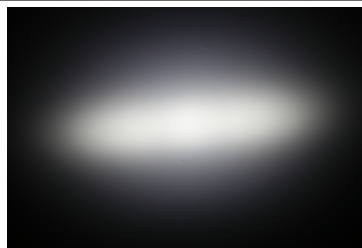

LED XP-G2
 FWHM 47.0 + 14.0°
 Efficiency 80 %
 Peak intensity 2.940 cd/lm
 Required components:

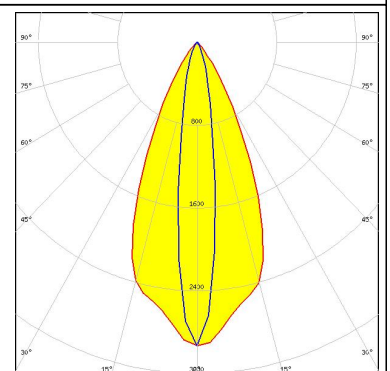
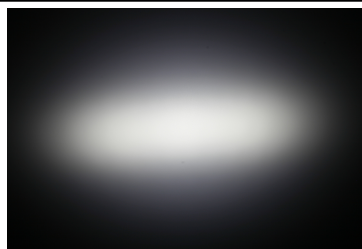

PHOTOMETRIC DATA (MEASURED):



LED XP-L2
 FWHM 45.0 + 20.0°
 Efficiency 86 %
 Peak intensity 1.900 cd/lm
 Required components:

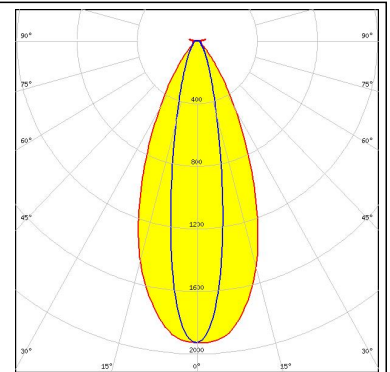
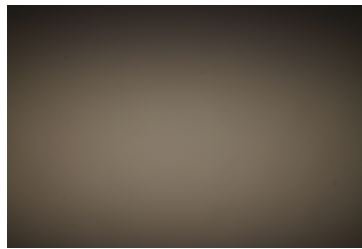

LED XT-E
 FWHM 47.0 + 16.0°
 Efficiency 79 %
 Peak intensity 2.800 cd/lm
 Required components:

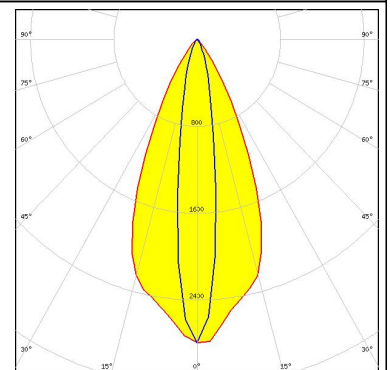

LED LUXEON M/MX
 FWHM 45.0 + 28.0°
 Efficiency 76 %
 Peak intensity 1.600 cd/lm
 Required components:

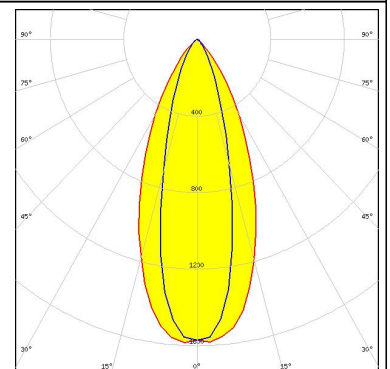
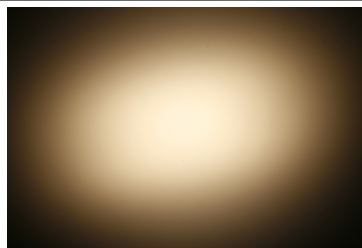

LED LUXEON MZ
 FWHM 47.0 + 23.0°
 Efficiency 73 %
 Peak intensity 2.000 cd/lm
 Required components:

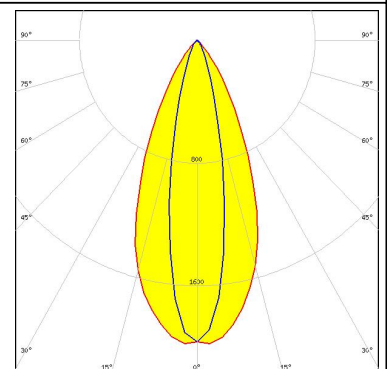
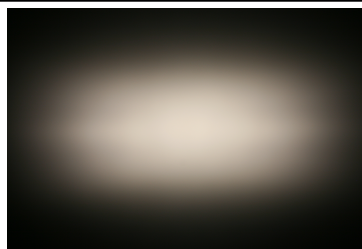

PHOTOMETRIC DATA (MEASURED):

LUMILEDS

LED LUXEON Rebel
 FWHM 47.0 + 15.0°
 Efficiency 80 %
 Peak intensity 3.000 cd/lm
 Required components:

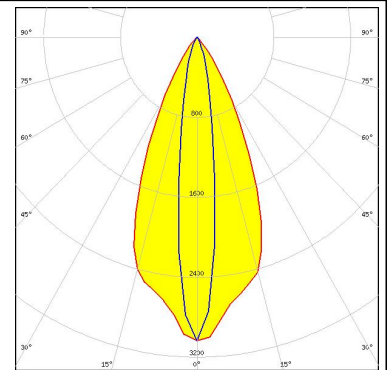

LUMILEDS

LED LUXEON Rebel ES
 FWHM 47.0 + 17.0°
 Efficiency 80 %
 Peak intensity 2.700 cd/lm
 Required components:

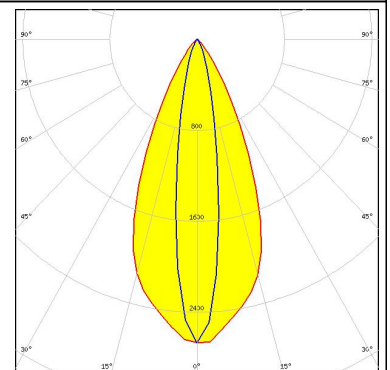
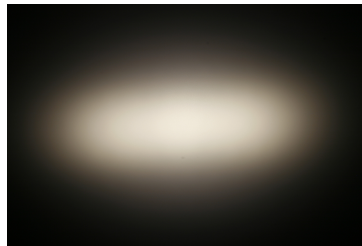

LUMILEDS

LED LUXEON T
 FWHM 47.0 + 17.0°
 Efficiency 80 %
 Peak intensity 2.800 cd/lm
 Required components:

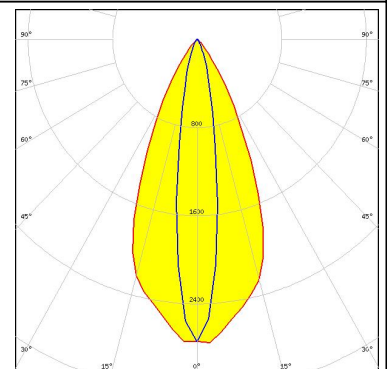
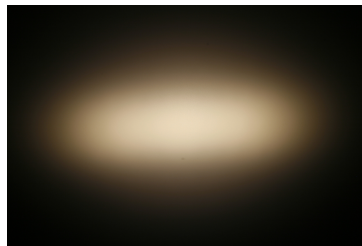

LUMILEDS

LED LUXEON TX
 FWHM 46.0 + 16.0°
 Efficiency 77 %
 Peak intensity 2.800 cd/lm
 Required components:

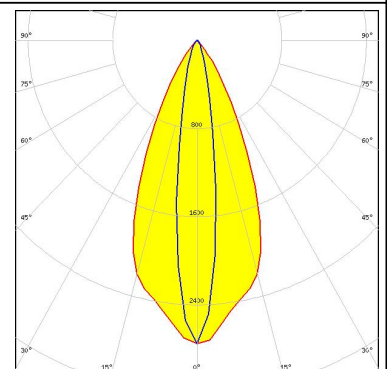
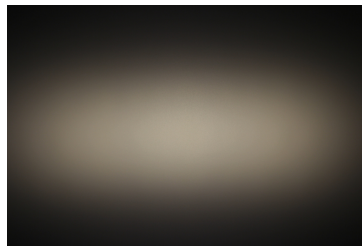

PHOTOMETRIC DATA (MEASURED):



LED LUXEON V
 FWHM 46.0 + 21.0°
 Efficiency 88 %
 Peak intensity 1.900 cd/lm
 Required components:

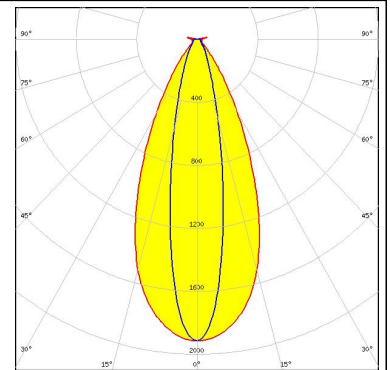

LED NVSxx19B/NVSxx19C
 FWHM 47.0 + 18.0°
 Efficiency 80 %
 Peak intensity 2.600 cd/lm
 Required components:

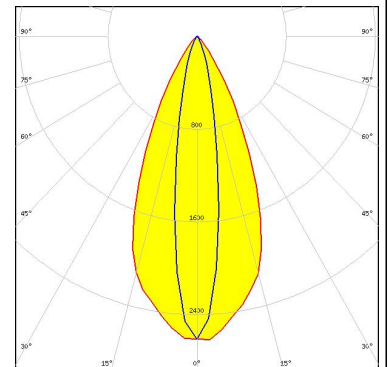

LED NWSx229A
 FWHM 20.0 + 45.0°
 Efficiency 74 %
 Peak intensity 2.000 cd/lm
 Required components:

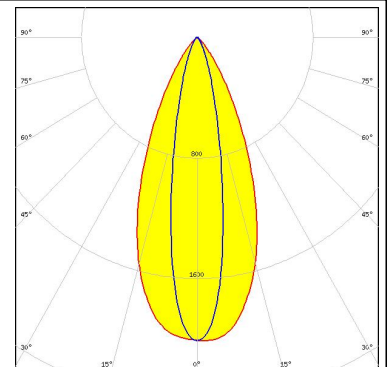
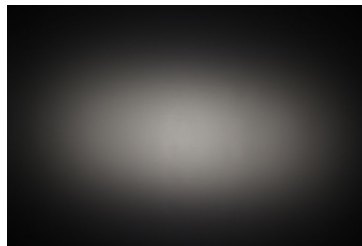

LED Oslon Square EC
 FWHM 47.0 + 17.0°
 Efficiency 79 %
 Peak intensity 2.800 cd/lm
 Required components:

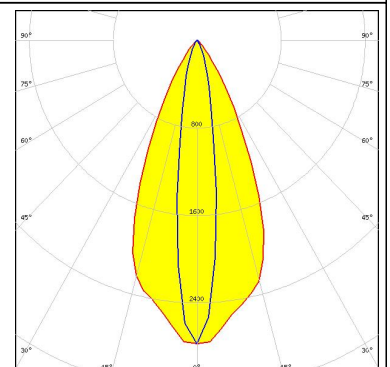

PHOTOMETRIC DATA (MEASURED):

SAMSUNG

LED LH181A
FWHM 46.0 + 22.0°
Efficiency 85 %
Peak intensity 1.700 cd/lm
Required components:

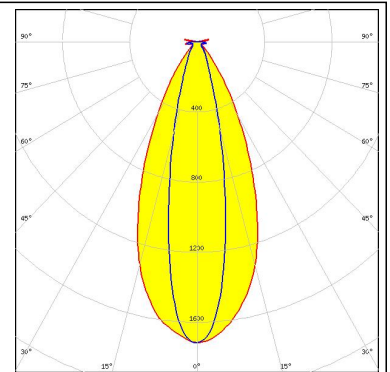
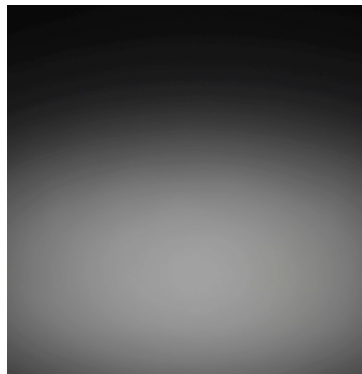

SAMSUNG

LED LH351Z
FWHM 47.0 + 15.0°
Efficiency 78 %
Peak intensity 2.800 cd/lm
Required components:

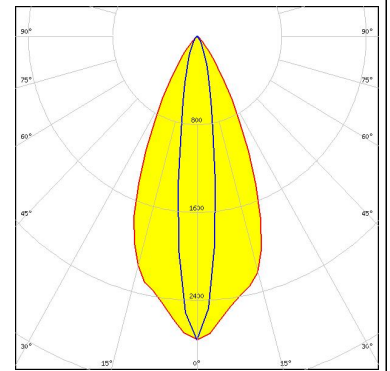
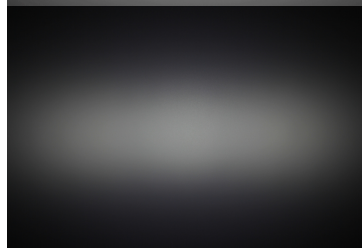

SEOUL SEMICONDUCTOR

LED Z8Y22P
FWHM 45.0 + 18.0°
Efficiency 86 %
Peak intensity 2.200 cd/lm
Required components:

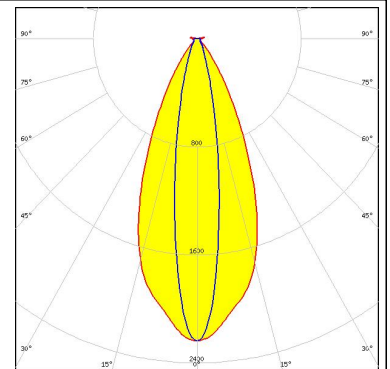
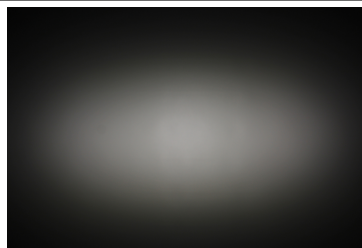

PHOTOMETRIC DATA (SIMULATED):



LED XP-L
FWHM 53.0 + 16.0°
Efficiency 86 %
Peak intensity 2.500 cd/lm
Required components:

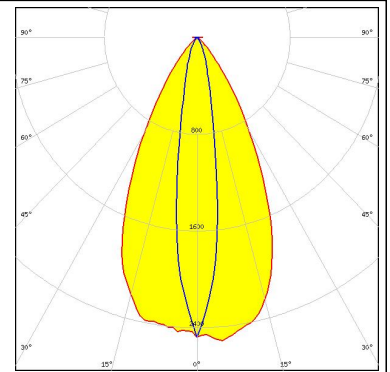

LED OSCONIQ P 7070
FWHM 49.0 + 25.0°
Efficiency 84 %
Peak intensity 1.800 cd/lm
Required components:

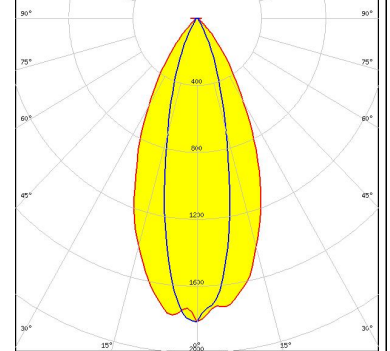

LED Oslon Square Gen3
FWHM 56.0 + 12.0°
Efficiency 88 %
Peak intensity 3.500 cd/lm
Required components:

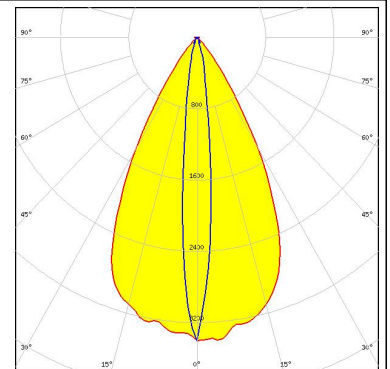

GENERAL INFORMATION:

NOTE: The typical beam angle will be changed by different color, chip size and chip position tolerance. The typical total beam angle is the full angle measured where the luminous intensity is half of the peak value.

MATERIALS:

As part of our continuous research and improvement processes, and to ensure the best possible quality and availability of our products, LEDiL reserves the right to change material grades without notice.

PRODUCT DATA USER AGREEMENT AND DISCLAIMER:

The measured data in the provided downloadable LEDiL Product Datasheets and Mechanical 2D-Drawings is rounded and provided as reference for planning. LEDiL Oy's optical specifications have been verified by conducting performance testing of the products in accordance with the company's quality system. The reported data are averaged results of multiple measurements with typical variation. LEDiL Oy reserves the right to without prior notification make changes and improvements to its products.

LEDiL Oy assumes neither warranty, nor guarantee nor any other liability of any kind for the contents and correctness of the provided data. The provided data has been generated with highest diligence but the provided data may in reality not represent the complete possible variation range of all intrinsic parameters. Therefore, in certain cases a deviation from the provided data could occur.

LEDiL Oy reserves the right to undertake technical changes of its products without further notification which could lead to changes in the provided data. LEDiL Oy assumes no liability of any kind for the possible deviation from any provided data or any other damage resulting from the usage of the provided data.

The user agrees to this disclaimer and user agreement with the download or usage of the provided files.

LEDiL Oy

Joensuunkatu 13
FI-24240 SALO
Finland

LEDiL Inc.

228 West Page Street
Suite D
Sycamore IL 60178
USA

Local sales and technical support

[www.ledil.com/
where_to_buy](http://www.ledil.com/where_to_buy)

Shipping locations

Salo, Finland
Hong Kong, China

Distribution Partners

[www.ledil.com/
where_to_buy](http://www.ledil.com/where_to_buy)