

EMILY-RS

~8° spot beam. 14.74 mm high lens.

TECHNICAL SPECIFICATIONS:

Dimensions	Ø 26.0 mm
Height	14.7 mm
Fastening	tape
ROHS compliant	yes ⓘ

MATERIAL SPECIFICATIONS:

Component	Type	Material	Colour	Finish
EMILY-RS	Single lens	PMMA	clear	
SPUTNIK-TAPE	Tape	PU tape	black	

ORDERING INFORMATION:

Component	Type	Qty in box	MOQ	MPQ	Box weight (kg)
CA13546_EMILY-RS » Box size: 480 x 280 x 300 mm	Single lens	1690	260	130	10.3



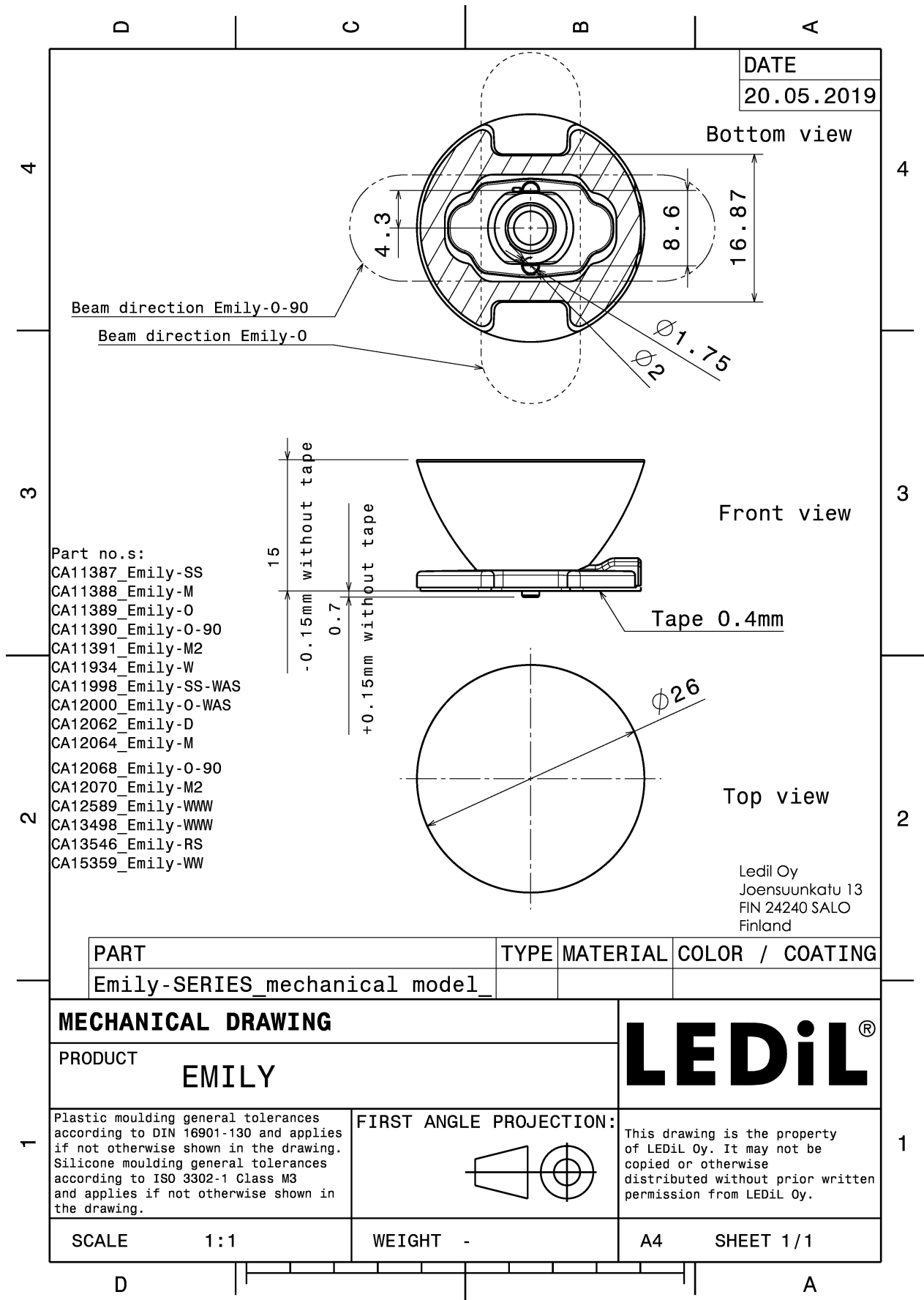

See also our general installation guide: www.ledil.com/installation_guide

PHOTOMETRIC DATA (MEASURED):

CREE

LED XB-H
 FWHM 9.0°
 Efficiency 88 %
 Peak intensity 24.7 cd/Im
 LEDs/each optic 1
 Light colour White
 Required components:



CREE

LED XP-G3
 FWHM 10.0°
 Efficiency 94 %
 Peak intensity 18 cd/Im
 LEDs/each optic 1
 Light colour White
 Required components:

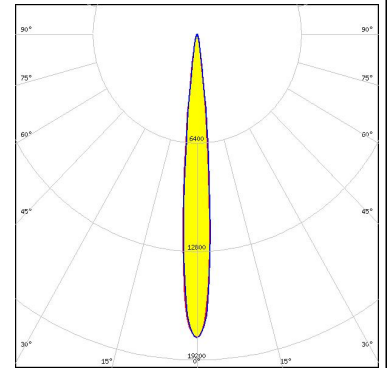

CREE

LED XP-L HD
 FWHM 13.0°
 Efficiency 89 %
 Peak intensity 13.1 cd/Im
 LEDs/each optic 1
 Light colour White
 Required components:

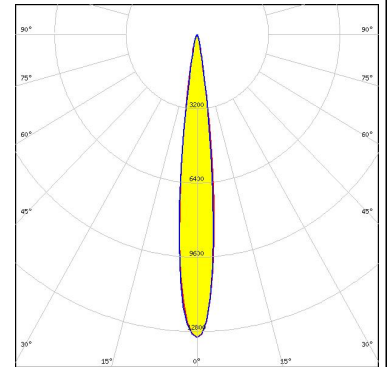

CREE

LED XP-L HI
 FWHM 8.0°
 Efficiency 88 %
 Peak intensity 28 cd/Im
 LEDs/each optic 1
 Light colour White
 Required components:

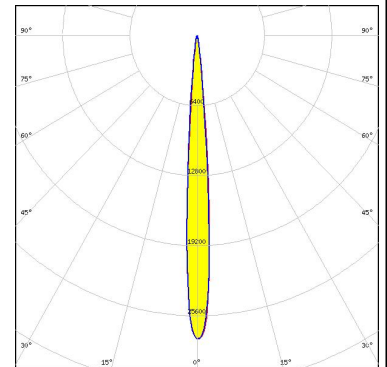

PHOTOMETRIC DATA (MEASURED):

CREE

LED XP-L2
 FWHM 13.0°
 Efficiency 93 %
 Peak intensity 10 cd/lm
 LEDs/each optic 1
 Light colour White
 Required components:

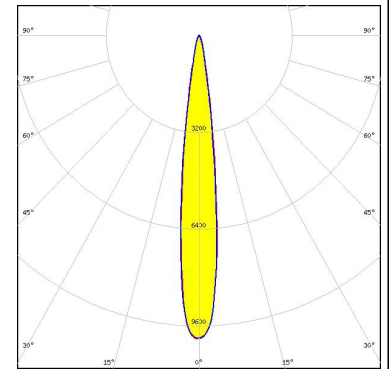

CREE

LED XQ-E HI
 FWHM 4.0°
 Efficiency 94 %
 Peak intensity 71.1 cd/lm
 LEDs/each optic 1
 Light colour White
 Required components:

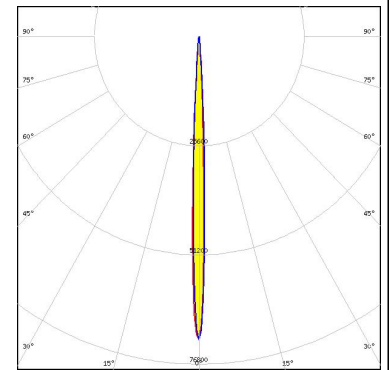

CREE

LED XT-E
 FWHM 8.0°
 Efficiency 91 %
 Peak intensity 23.9 cd/lm
 LEDs/each optic 1
 Light colour White
 Required components:

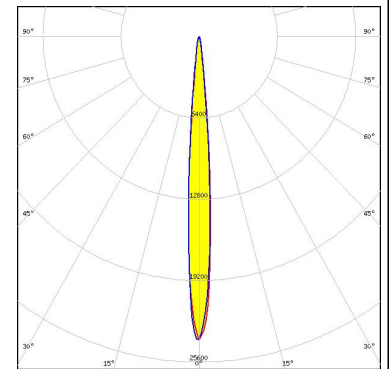
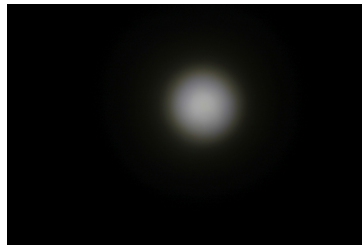

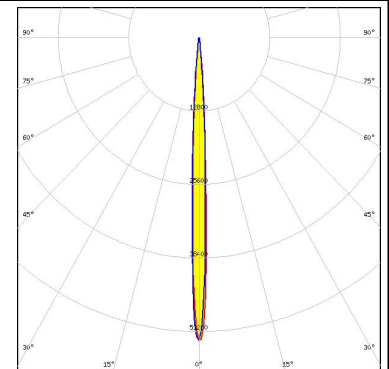

LUMILEDS

LED LUXEON Z ES
 FWHM 5.0°
 Efficiency 91 %
 Peak intensity 52 cd/lm
 LEDs/each optic 1
 Light colour White
 Required components:

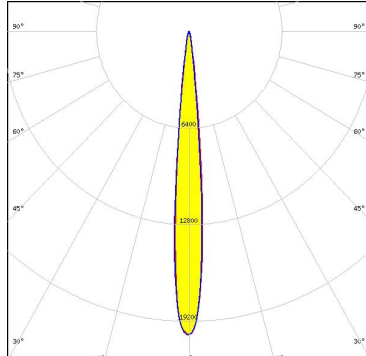

PHOTOMETRIC DATA (MEASURED):

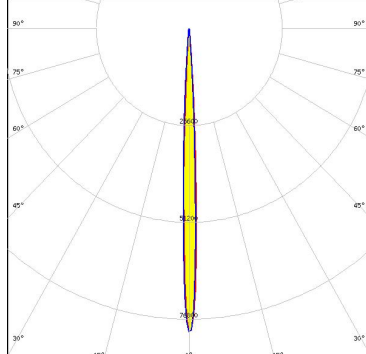
<p>NICHIA</p> <p>LED NVSW219D FWHM 10.0° Efficiency 94 % Peak intensity 20.1 cd/Im LEDs/each optic 1 Light colour White Required components:</p>		
<p>OSRAM Opto Semiconductors</p> <p>LED OSLON Square EC FWHM 8.0° Efficiency 90 % Peak intensity 29.1 cd/Im LEDs/each optic 1 Light colour White Required components:</p>		
<p>OSRAM Opto Semiconductors</p> <p>LED PLPVEC2 850A FWHM 4.0° Efficiency % LEDs/each optic 1 Light colour IR Required components:</p>		
<p>SEOL SEOUL SEMICONDUCTOR</p> <p>LED nPola FWHM 5.0° Efficiency 94 % Peak intensity 81.2 cd/Im LEDs/each optic 1 Light colour White Required components:</p>		

PHOTOMETRIC DATA (MEASURED):



PHOTOMETRIC DATA (SIMULATED):

CREE

LED XHP35 HI
 FWHM 10.0°
 Efficiency 96 %
 Peak intensity 22 cd/lm
 LEDs/each optic 1
 Light colour White
 Required components:

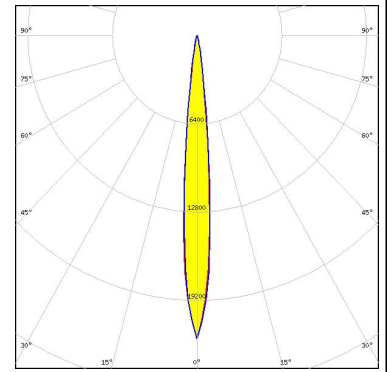

CREE

LED XP-E2
 FWHM 6.0°
 Efficiency 94 %
 Peak intensity 51.8 cd/lm
 LEDs/each optic 1
 Light colour White
 Required components:

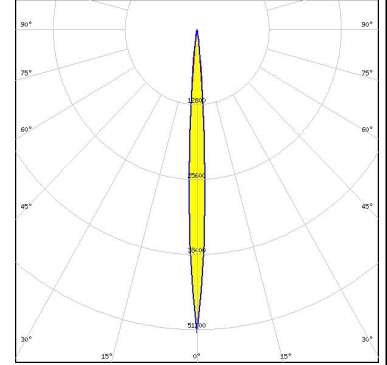

CREE

LED XP-G2
 FWHM 8.0°
 Efficiency 94 %
 Peak intensity 30.4 cd/lm
 LEDs/each optic 1
 Light colour White
 Required components:

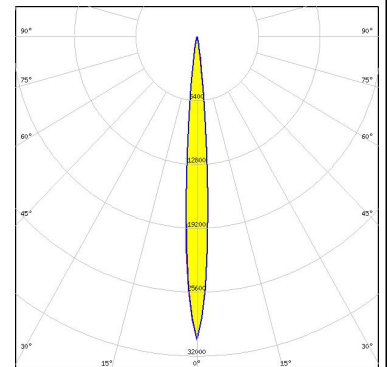

CREE

LED XP-G2 HE
 FWHM 10.0°
 Efficiency 95 %
 Peak intensity 19.1 cd/lm
 LEDs/each optic 1
 Light colour White
 Required components:

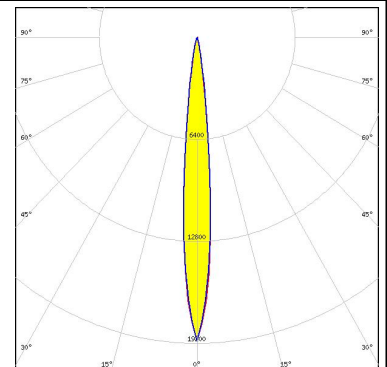

PHOTOMETRIC DATA (SIMULATED):

LUMILEDS

LED LUXEON C
 FWHM 7.0°
 Efficiency 94 %
 Peak intensity 37.3 cd/lm
 LEDs/each optic 1
 Light colour Royal Blue
 Required components:

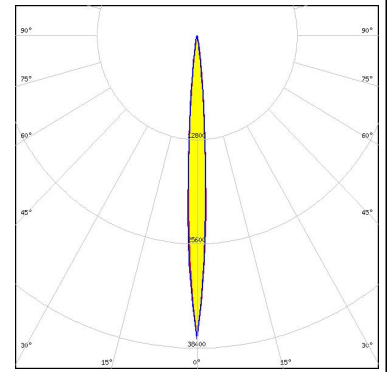

LUMILEDS

LED LUXEON Rebel
 FWHM 6.0°
 Efficiency 94 %
 Peak intensity 41.5 cd/lm
 LEDs/each optic 1
 Light colour White
 Required components:

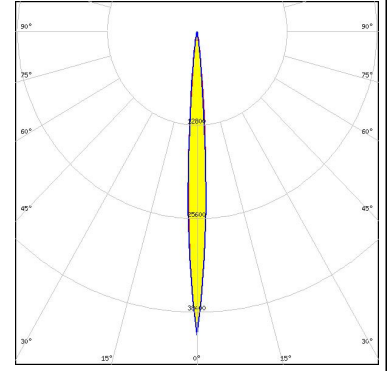

LUMILEDS

LED LUXEON Rebel Plus
 FWHM 6.0°
 Efficiency 94 %
 Peak intensity 42.1 cd/lm
 LEDs/each optic 1
 Light colour White
 Required components:

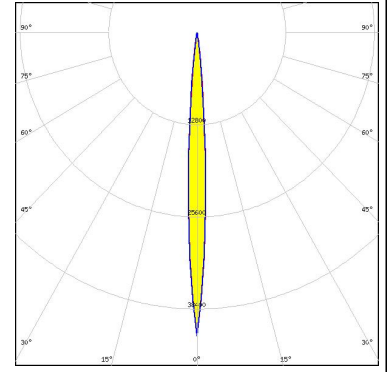

LUMILEDS

LED LUXEON Rubix
 FWHM 6.0°
 Efficiency 96 %
 Peak intensity 62.6 cd/lm
 LEDs/each optic 1
 Light colour White
 Required components:

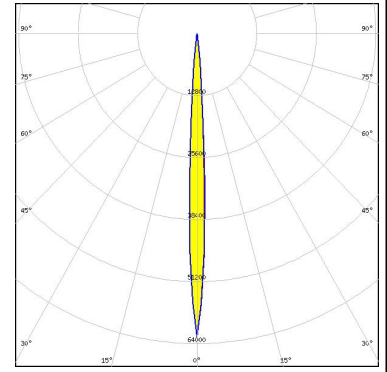

PHOTOMETRIC DATA (SIMULATED):

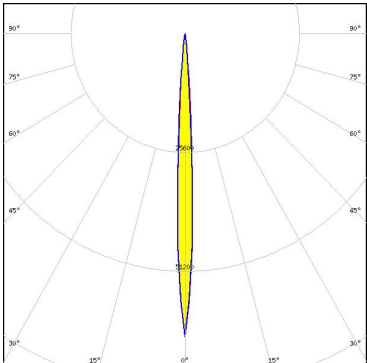
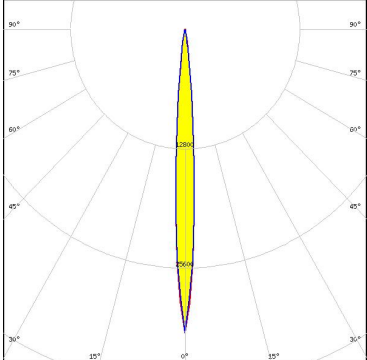
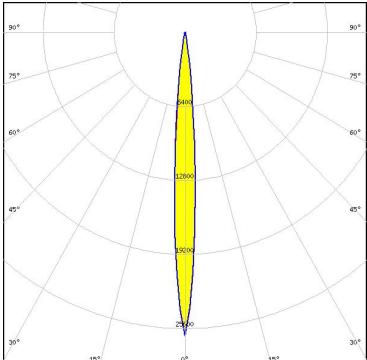
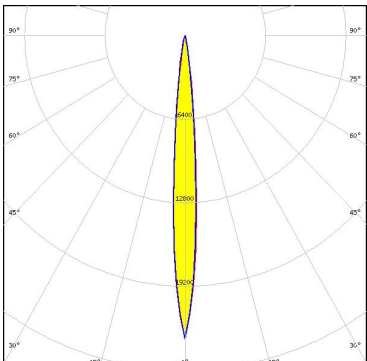
<p>LUMILEDS</p> <p>LED LUXEON Z FWHM 5.9° Efficiency 94 % Peak intensity 65.3 cd/lm LEDs/each optic 1 Light colour White Required components:</p>	
<p>NICHIA</p> <p>LED NCSxE17A FWHM 8.0° Efficiency 92 % Peak intensity 32.5 cd/lm LEDs/each optic 1 Light colour White Required components:</p>	
<p>NICHIA</p> <p>LED NVSxE21A FWHM 8.0° Efficiency 93 % Peak intensity 26.2 cd/lm LEDs/each optic 1 Light colour White Required components:</p>	
<p>OSRAM <small>Opto Semiconductors</small></p> <p>LED Duris S5 (Single chip) FWHM 9.0° Efficiency 89 % Peak intensity 23.2 cd/lm LEDs/each optic 1 Light colour Purple Required components:</p>	

PHOTOMETRIC DATA (SIMULATED):

OSRAM

Opto Semiconductors

LED Duris S5 (Single chip)
 FWHM 8.0°
 Efficiency 96 %
 Peak intensity 25.4 cd/lm
 LEDs/each optic 1
 Light colour White
 Required components:

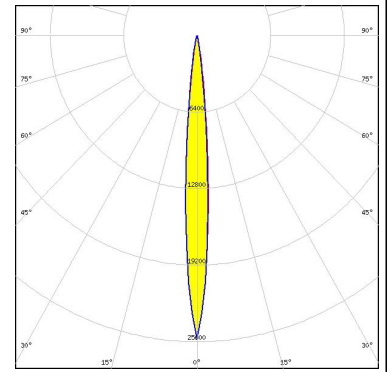

OSRAM

Opto Semiconductors

LED OSCONIQ C 2424
 FWHM 8.0°
 Efficiency 96 %
 Peak intensity 36.2 cd/lm
 LEDs/each optic 1
 Light colour White
 Required components:

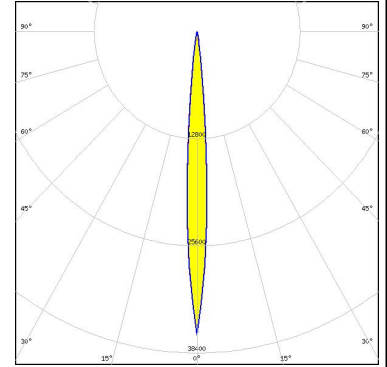

OSRAM

Opto Semiconductors

LED OSCONIQ P 3030
 FWHM 10.0°
 Efficiency 96 %
 Peak intensity 20.8 cd/lm
 LEDs/each optic 1
 Light colour White
 Required components:

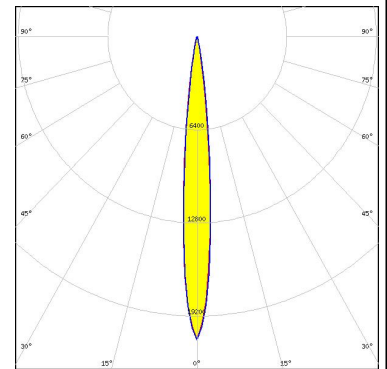

OSRAM

Opto Semiconductors

LED OSLON Black
 FWHM 11.0°
 Efficiency 94 %
 Peak intensity 19.7 cd/lm
 LEDs/each optic 1
 Light colour White
 Required components:

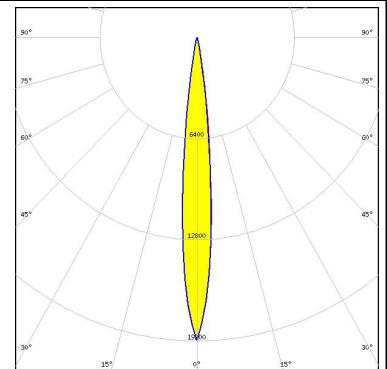

PHOTOMETRIC DATA (SIMULATED):

OSRAM

Opto Semiconductors

LED OSLON Black Flat
 FWHM 6.3°
 Efficiency 94 %
 Peak intensity 50.4 cd/lm
 LEDs/each optic 1
 Light colour White
 Required components:

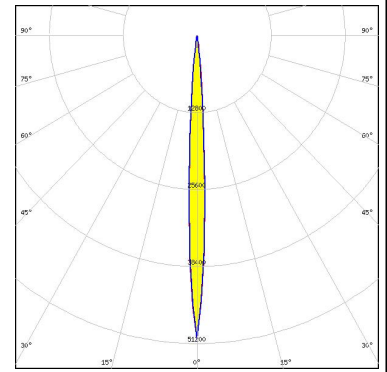

OSRAM

Opto Semiconductors

LED OSLON Square CSSRM2/CSSRM3
 FWHM 11.0°
 Efficiency 94 %
 Peak intensity 19.4 cd/lm
 LEDs/each optic 1
 Light colour White
 Required components:

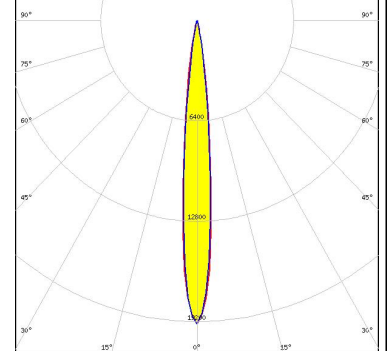

OSRAM

Opto Semiconductors

LED OSLON SSL 120
 FWHM 7.0°
 Efficiency 96 %
 Peak intensity 45.5 cd/lm
 LEDs/each optic 1
 Light colour Amber
 Required components:

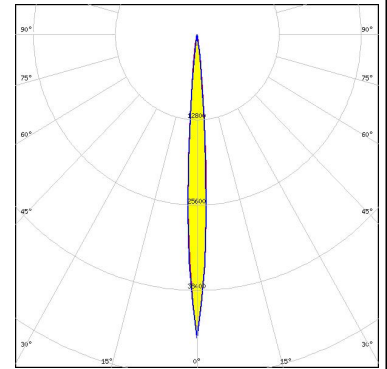

OSRAM

Opto Semiconductors

LED OSLON SSL 150
 FWHM 6.0°
 Efficiency 96 %
 Peak intensity 47.7 cd/lm
 LEDs/each optic 1
 Light colour White
 Required components:

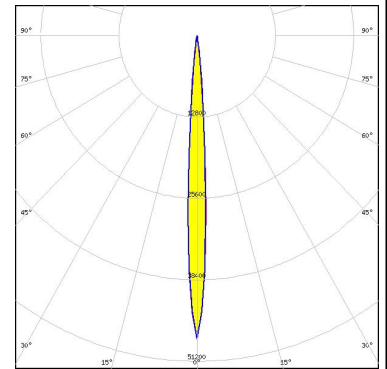

PHOTOMETRIC DATA (SIMULATED):

OSRAM

Opto Semiconductors

LED OSLON SSL 150
 FWHM 7.0°
 Efficiency 96 %
 Peak intensity 44.5 cd/lm
 LEDs/each optic 1
 Light colour Amber
 Required components:

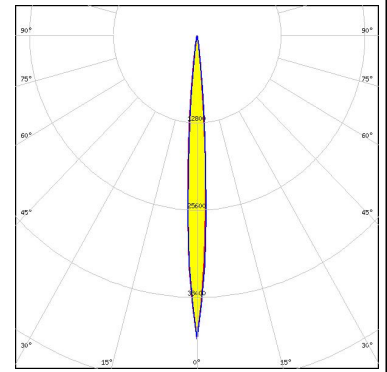

OSRAM

Opto Semiconductors

LED OSLON SSL 80
 FWHM 7.0°
 Efficiency 94 %
 Peak intensity 38 cd/lm
 LEDs/each optic 1
 Light colour White
 Required components:

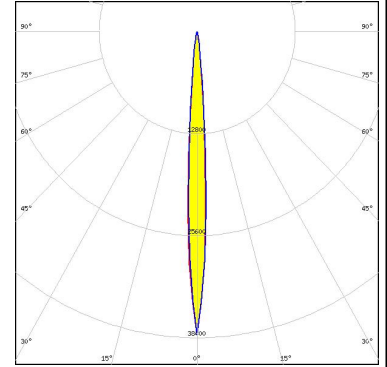

OSRAM

Opto Semiconductors

LED SFH 4170S
 FWHM 6.0°
 Efficiency 87 %
 LEDs/each optic 1
 Light colour IR
 Required components:

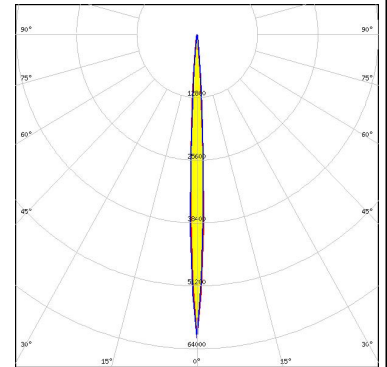

OSRAM

Opto Semiconductors

LED SFH 4716AS
 FWHM 8.0°
 Efficiency 96 %
 LEDs/each optic 1
 Light colour IR
 Required components:

PHOTOMETRIC DATA (SIMULATED):

SAMSUNG

LED	LM301B
FWHM	9.0°
Efficiency	94 %
Peak intensity	28.5 cd/lm
LEDs/each optic	1
Light colour	White
Required components:	

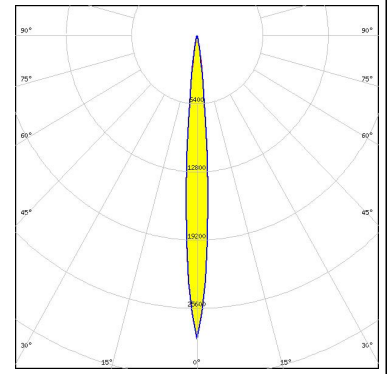

GENERAL INFORMATION:

NOTE: The typical beam angle will be changed by different color, chip size and chip position tolerance. The typical total beam angle is the full angle measured where the luminous intensity is half of the peak value.

MATERIALS:

As part of our continuous research and improvement processes, and to ensure the best possible quality and availability of our products, LEDiL reserves the right to change material grades without notice.

PRODUCT DATA USER AGREEMENT AND DISCLAIMER:

The measured data in the provided downloadable LEDiL Product Datasheets and Mechanical 2D-Drawings is rounded and provided as reference for planning. LEDiL Oy's optical specifications have been verified by conducting performance testing of the products in accordance with the company's quality system. The reported data are averaged results of multiple measurements with typical variation. LEDiL Oy reserves the right to without prior notification make changes and improvements to its products.

LEDiL Oy assumes neither warranty, nor guarantee nor any other liability of any kind for the contents and correctness of the provided data. The provided data has been generated with highest diligence but the provided data may in reality not represent the complete possible variation range of all intrinsic parameters. Therefore, in certain cases a deviation from the provided data could occur.

LEDiL Oy reserves the right to undertake technical changes of its products without further notification which could lead to changes in the provided data. LEDiL Oy assumes no liability of any kind for the possible deviation from any provided data or any other damage resulting from the usage of the provided data.

The user agrees to this disclaimer and user agreement with the download or usage of the provided files.

LEDiL Oy

Joensuunkatu 13
FI-24240 SALO
Finland

LEDiL Inc.

228 West Page Street
Suite D
Sycamore IL 60178
USA

Ledil Optics Technology (Shenzhen) Co., Ltd.

405 , Block B
Casic Motor Building
Shenzhen 518057
P.R.CHINA

Local sales and technical support

[www.ledil.com/
where_to_buy](http://www.ledil.com/where_to_buy)

Shipping locations

Salo, Finland
Hong Kong, China

Distribution Partners

[www.ledil.com/
where_to_buy](http://www.ledil.com/where_to_buy)