

## HEIDI-SS

~15° smooth spot beam optimized for LUXEON Rebel ES

### TECHNICAL SPECIFICATIONS:

Dimensions	Ø 21.6 mm
Height	11.7 mm
Fastening	tape, pin
Colour	clear
Box size	480 x 280 x 300 mm
Box weight	11.1 kg
Quantity in Box	3264 pcs
ROHS compliant	yes ⓘ



### MATERIAL SPECIFICATIONS:

Component	Type	Material	Colour
HEIDI-SS	Lens	PMMA	clear
HEIDI-TAPE	Tape	PU tape	black

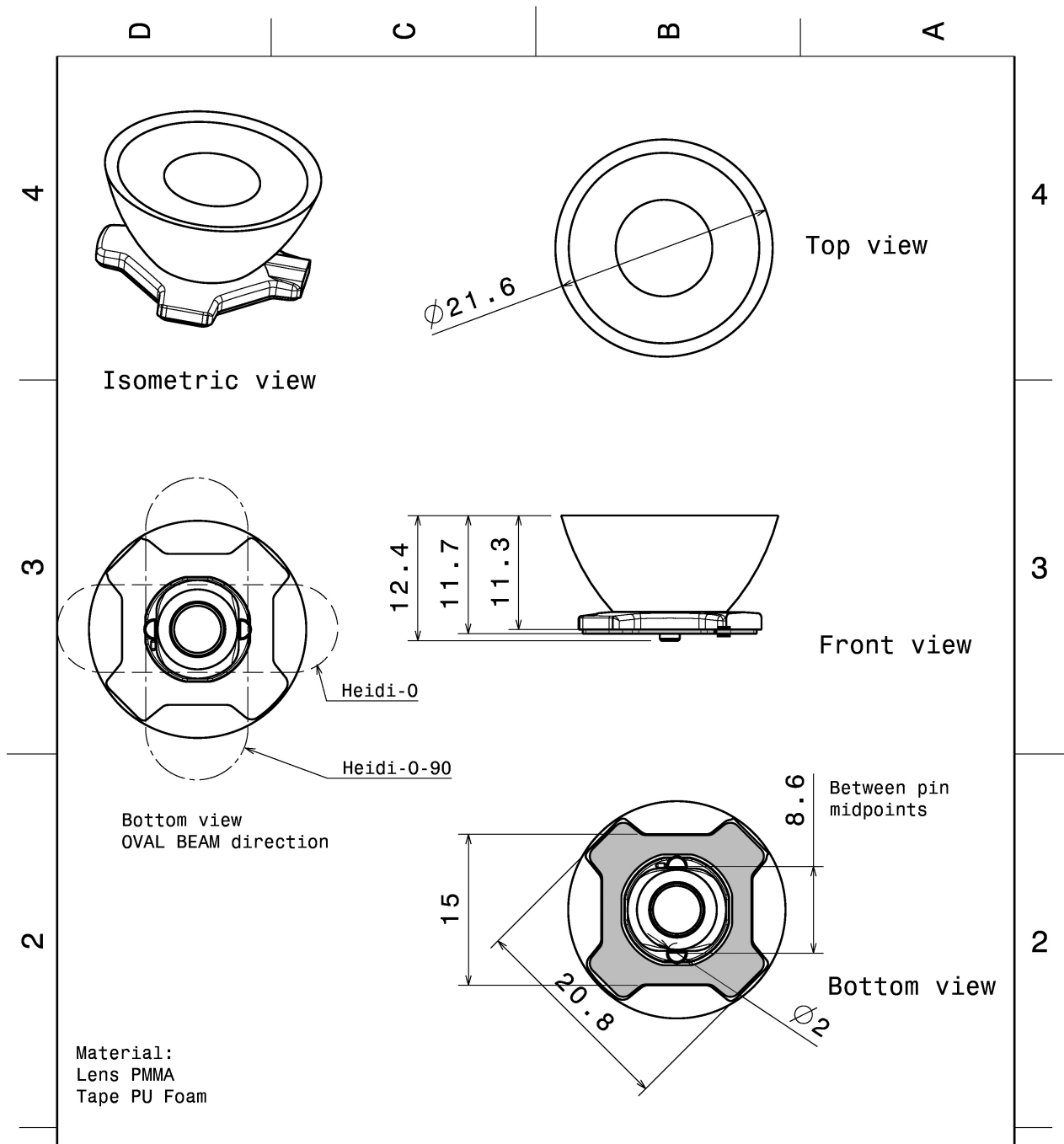

This drawing is our property. It can't be reproduced or communicated without our written agreement.		<b>LEDiL</b>		Ledil Oy Salorankatu 10 FIN-24100 SALO Finland	
DRAWN BY ah		DATE 1.2.2012		DRAWING TITLE Datasheet Heidi-Series Assy	
CHECKED BY	DATE	SIZE A4	DRAWING NUMBER		REV 2
DESIGNED BY	DATE	SCALE 2:1	WEIGHT (g)	SHEET 1/1	

**PHOTOMETRIC DATA (MEASURED):**



LED XP-G3  
FWHM 16.0°  
Efficiency 94 %  
Peak intensity 6.900 cd/lm  
Required components:

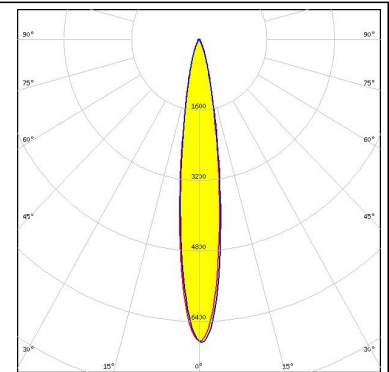

LED LUXEON R  
FWHM 16.0°  
Efficiency 91 %  
Peak intensity 6.260 cd/lm  
Required components:



LED LUXEON Rebel  
FWHM 14.0°  
Efficiency 89 %  
Peak intensity 8.700 cd/lm  
Required components:

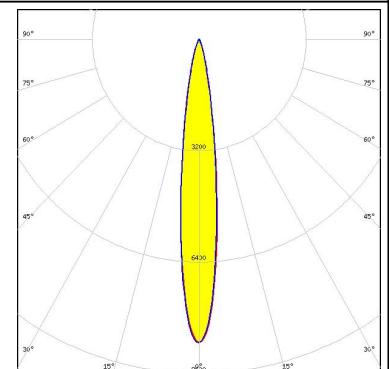
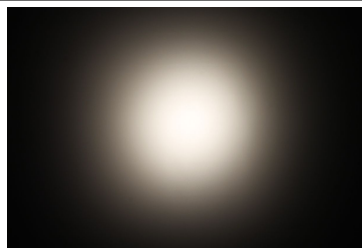

LED LUXEON Rebel ES  
FWHM 14.0°  
Efficiency 91 %  
Peak intensity 6.300 cd/lm  
Required components:



### PHOTOMETRIC DATA (MEASURED):



LED NVSW219D  
 FWHM 15.0°  
 Efficiency 94 %  
 Peak intensity 7.600 cd/lm  
 Required components:

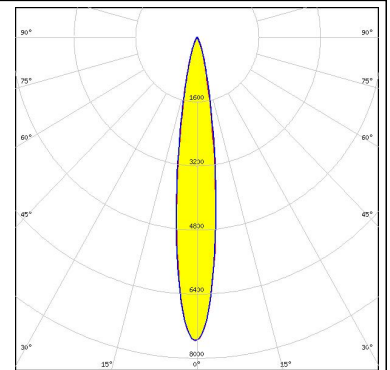
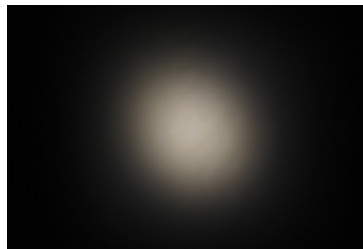

LED NVSW3x9A  
 FWHM 16.0°  
 Efficiency 92 %  
 Peak intensity 6.700 cd/lm  
 Required components:

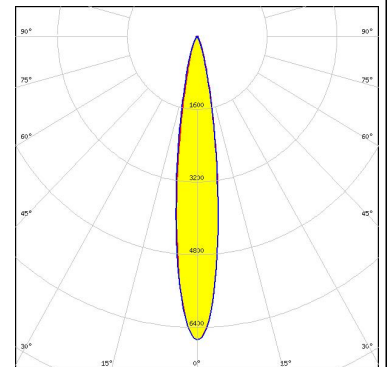

LED NWSx229A  
 FWHM 18.0°  
 Efficiency 86 %  
 Peak intensity 5.300 cd/lm  
 Required components:

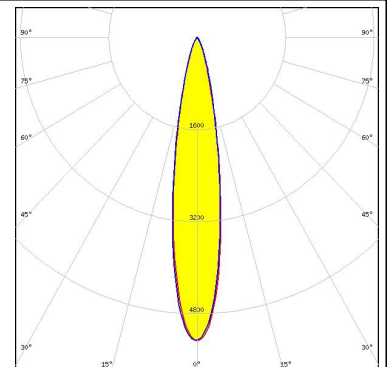

LED Oslon SSL 150  
 FWHM 12.0°  
 Efficiency 91 %  
 Peak intensity 11.700 cd/lm  
 Required components:

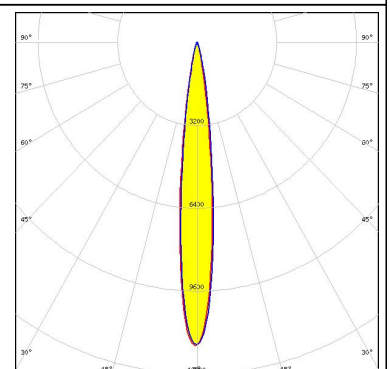
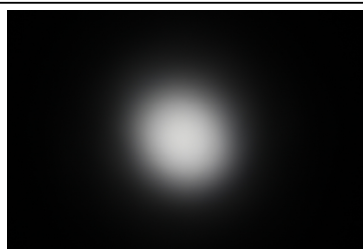

## PHOTOMETRIC DATA (MEASURED):

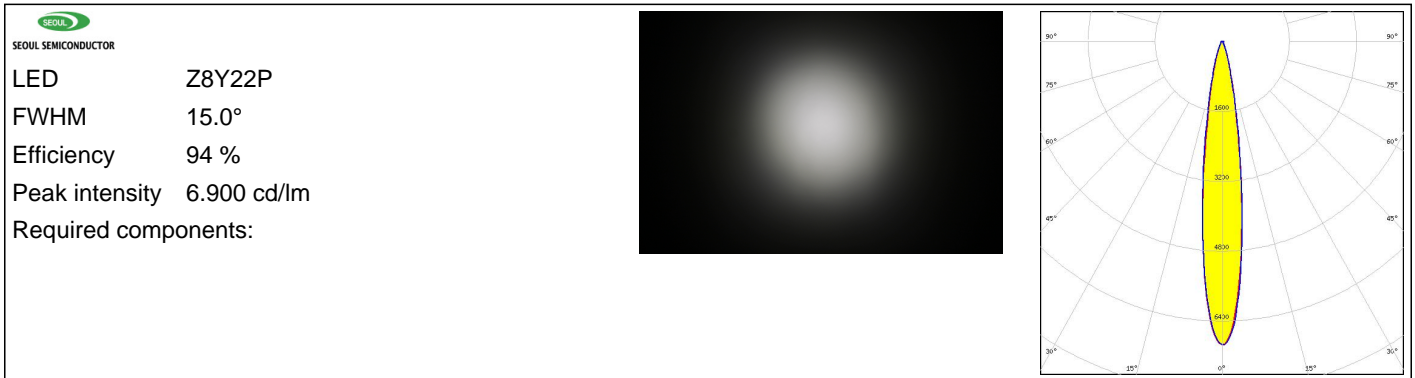

### PHOTOMETRIC DATA (SIMULATED):

**OSRAM**  
Opto Semiconductors

LED Oslon Black  
FWHM 14.0°  
Efficiency 94 %  
Peak intensity 12.000 cd/lm  
Required components:

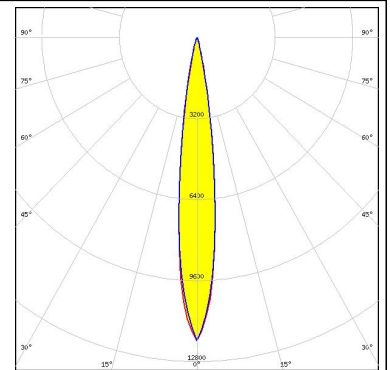

**OSRAM**  
Opto Semiconductors

LED Oslon Black Flat  
FWHM 13.0°  
Efficiency 94 %  
Peak intensity 15.800 cd/lm  
Required components:

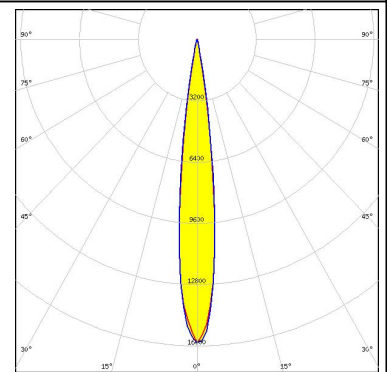

### GENERAL INFORMATION:

NOTE: The typical beam angle will be changed by different color, chip size and chip position tolerance. The typical total beam angle is the full angle measured where the luminous intensity is half of the peak value.

### MATERIALS:

As part of our continuous research and improvement processes, and to ensure the best possible quality and availability of our products, LEDiL reserves the right to change material grades without notice.

### PRODUCT DATA USER AGREEMENT AND DISCLAIMER:

The measured data in the provided downloadable LEDiL Product Datasheets and Mechanical 2D-Drawings is rounded and provided as reference for planning. LEDiL Oy's optical specifications have been verified by conducting performance testing of the products in accordance with the company's quality system. The reported data are averaged results of multiple measurements with typical variation. LEDiL Oy reserves the right to without prior notification make changes and improvements to its products.

LEDiL Oy assumes neither warranty, nor guarantee nor any other liability of any kind for the contents and correctness of the provided data. The provided data has been generated with highest diligence but the provided data may in reality not represent the complete possible variation range of all intrinsic parameters. Therefore, in certain cases a deviation from the provided data could occur.

LEDiL Oy reserves the right to undertake technical changes of its products without further notification which could lead to changes in the provided data. LEDiL Oy assumes no liability of any kind for the possible deviation from any provided data or any other damage resulting from the usage of the provided data.

The user agrees to this disclaimer and user agreement with the download or usage of the provided files.

#### LEDiL Oy

Joensuunkatu 13  
FI-24240 SALO  
Finland

#### LEDiL Inc.

228 West Page Street  
Suite D  
Sycamore IL 60178  
USA

#### Local sales and technical support

[www.ledil.com/  
where\\_to\\_buy](http://www.ledil.com/where_to_buy)

#### Shipping locations

Salo, Finland  
Hong Kong, China

#### Distribution Partners

[www.ledil.com/  
where\\_to\\_buy](http://www.ledil.com/where_to_buy)