

HEIDI-W2

~45° wide beam

TECHNICAL SPECIFICATIONS:

Dimensions	Ø 21.6 mm
Height	12 mm
Fastening	tape, pin
Colour	clear
Box size	480 x 280 x 300 mm
Box weight	11.1 kg
Quantity in Box	3264 pcs
ROHS compliant	yes ⓘ



MATERIAL SPECIFICATIONS:

Component	Type	Material	Colour
HEIDI-W2	Lens	PMMA	clear
HEIDI-TAPE	Tape	PU tape	black

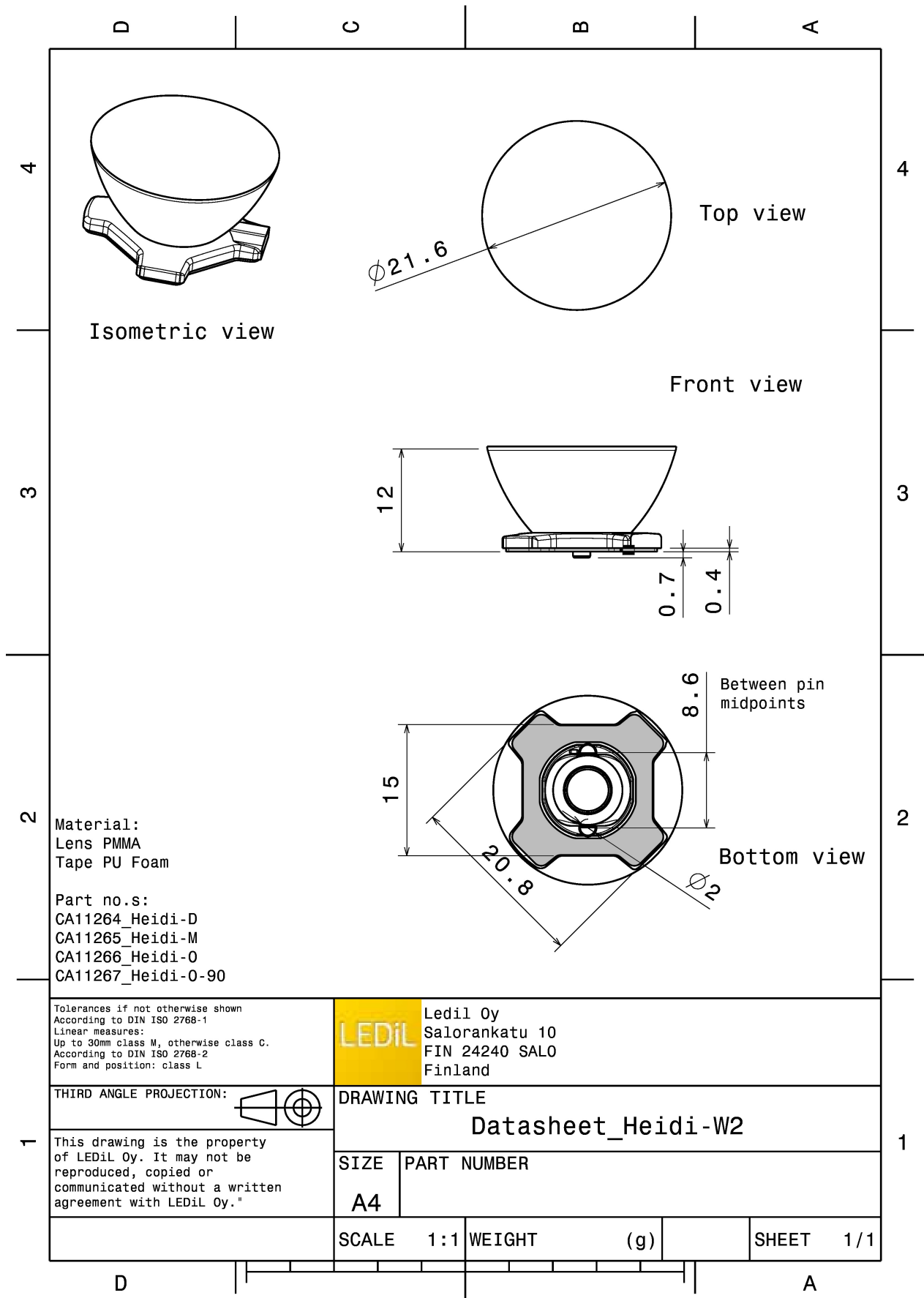

PHOTOMETRIC DATA (MEASURED):

CREE

LED XB-D
FWHM 46.0°
Efficiency 76 %
Peak intensity 1.020 cd/lm
Required components:

CREE

LED XB-H
FWHM 45.0°
Efficiency 80 %
Peak intensity 1.200 cd/lm
Required components:

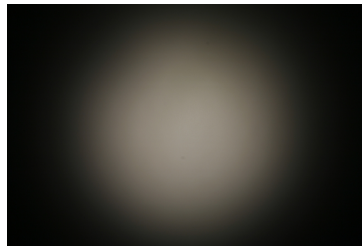

CREE

LED XHP35 HD
FWHM 46.0°
Efficiency 81 %
Peak intensity 1.270 cd/lm
Required components:

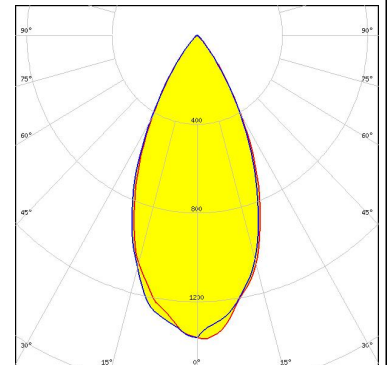
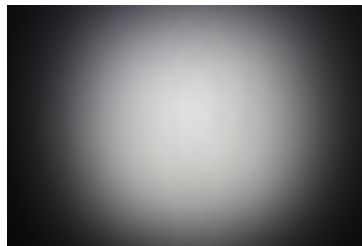

CREE

LED XHP35 HI
FWHM 44.0°
Efficiency 91 %
Peak intensity 1.400 cd/lm
Required components:

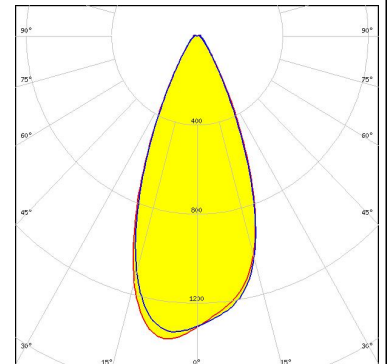
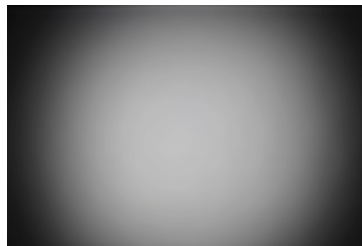

PHOTOMETRIC DATA (MEASURED):

CREE

LED XP-E
FWHM 44.0°
Efficiency 81 %
Peak intensity 1.130 cd/lm
Required components:

CREE

LED XP-E2
FWHM 45.0°
Efficiency 81 %
Peak intensity 1.400 cd/lm
Required components:

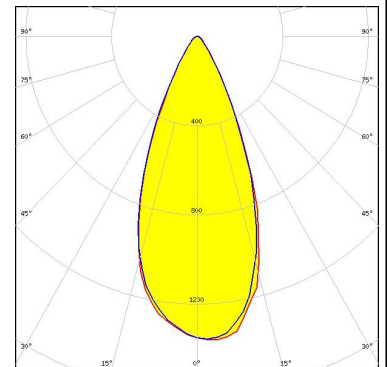
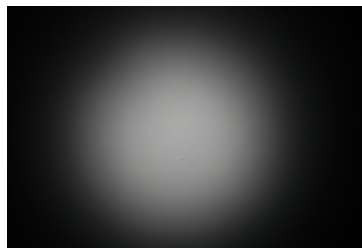

CREE

LED XP-G
FWHM 44.0°
Efficiency 81 %
Peak intensity 1.110 cd/lm
Required components:

CREE

LED XP-G2
FWHM 46.0°
Efficiency 80 %
Peak intensity 1.300 cd/lm
Required components:

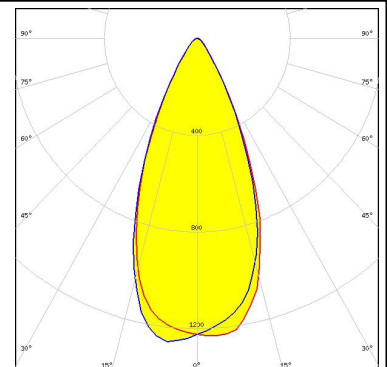
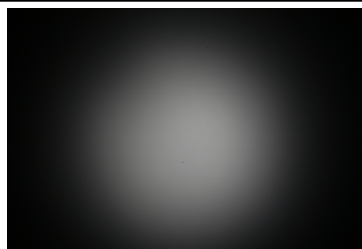

PHOTOMETRIC DATA (MEASURED):

CREE 

LED XP-G3
 FWHM 42.0°
 Efficiency 91 %
 Peak intensity 1.300 cd/lm
 Required components:

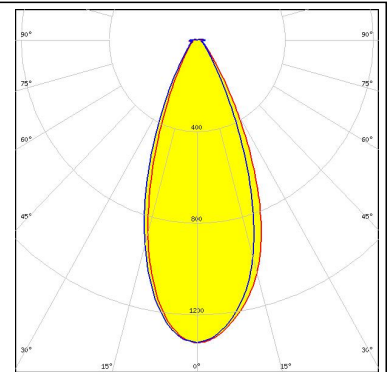
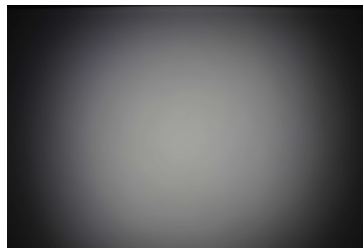

CREE 

LED XP-L
 FWHM 44.0°
 Efficiency 79 %
 Peak intensity 1.260 cd/lm
 Required components:

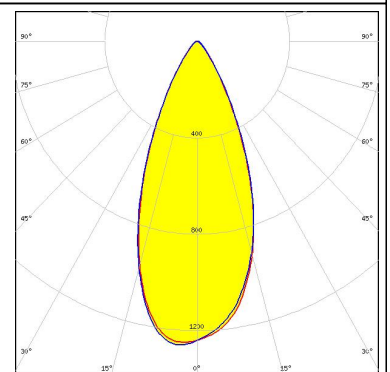
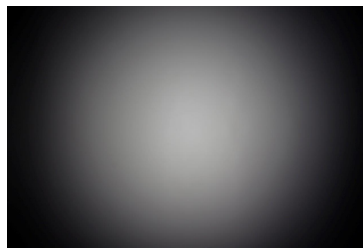

CREE 

LED XQ-E HI
 FWHM 42.0°
 Efficiency 87 %
 Peak intensity 1.300 cd/lm
 Required components:

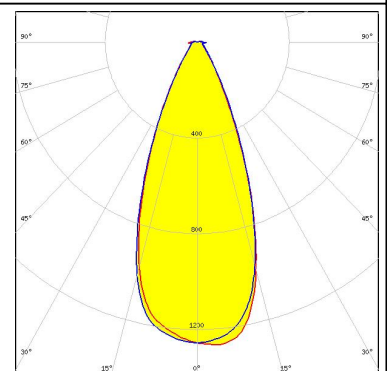
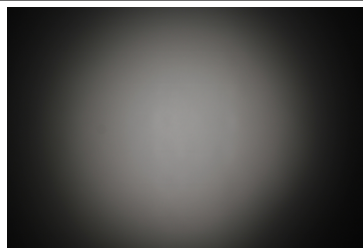

CREE 

LED XT-E
 FWHM 42.0°
 Efficiency 75 %
 Peak intensity 1.300 cd/lm
 Required components:

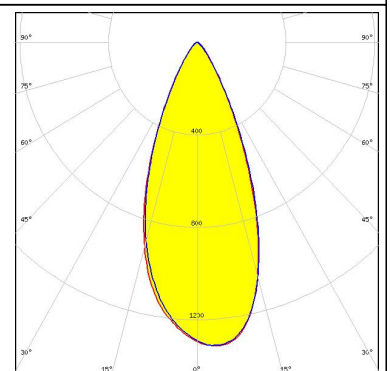
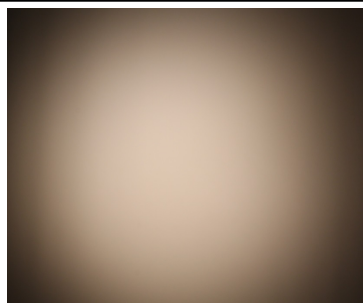

PHOTOMETRIC DATA (MEASURED):

LUMILEDS

LED LUXEON C
FWHM 40.0°
Efficiency 71 %
Peak intensity 1.360 cd/lm
Required components:

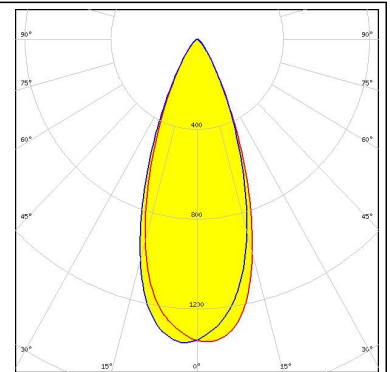
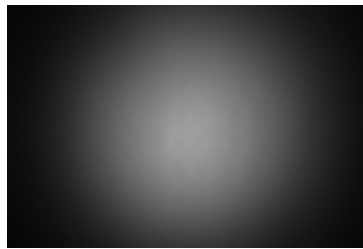

LUMILEDS

LED LUXEON CZ
FWHM 42.0°
Efficiency 93 %
Peak intensity 1.400 cd/lm
Required components:

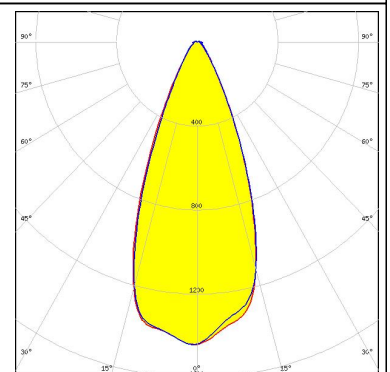
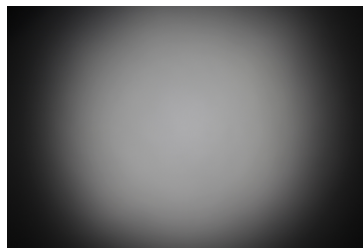

LUMILEDS

LED LUXEON Rebel
FWHM 49.0°
Efficiency 85 %
Peak intensity 0.966 cd/lm
Required components:

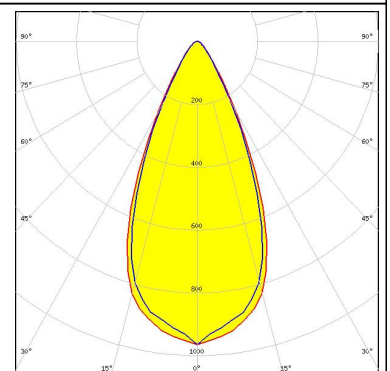

LUMILEDS

LED LUXEON T
FWHM 44.0°
Efficiency 83 %
Peak intensity 1.300 cd/lm
Required components:

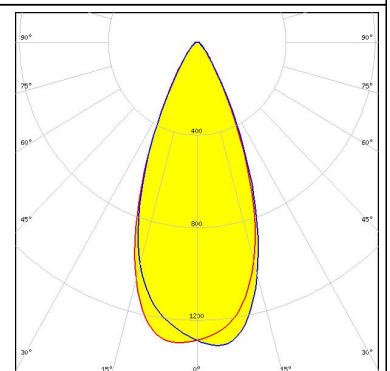
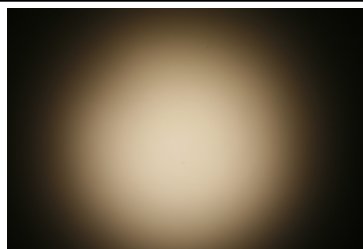

PHOTOMETRIC DATA (MEASURED):



LED LUXEON TX
 FWHM 44.0°
 Efficiency 78 %
 Peak intensity 1.300 cd/lm
 Required components:

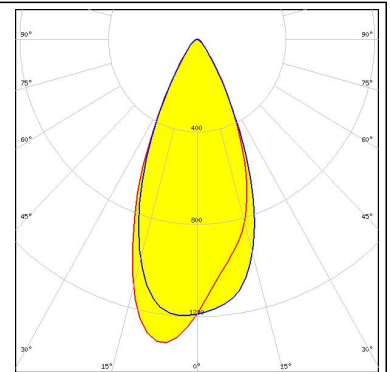
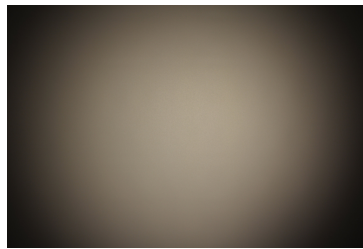

LED NCSxx19B
 FWHM 45.0°
 Efficiency 78 %
 Peak intensity 1.300 cd/lm
 Required components:

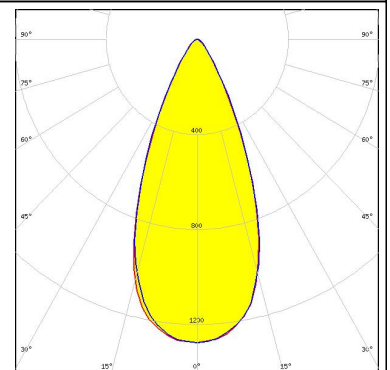
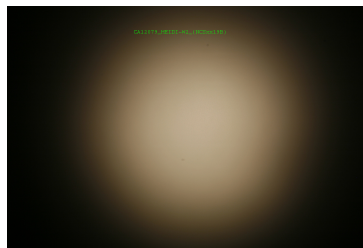

LED NVSW219D
 FWHM 45.0°
 Efficiency 93 %
 Peak intensity 1.400 cd/lm
 Required components:

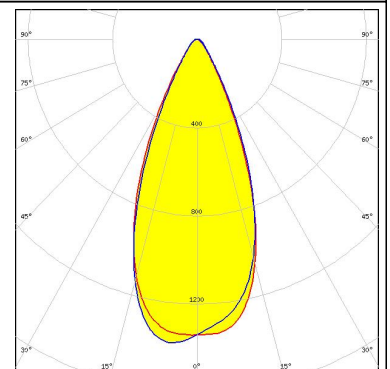
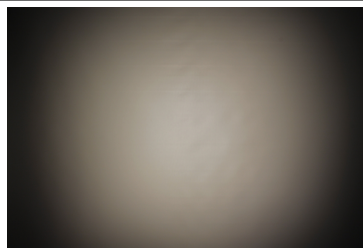

LED NVSW3x9A
 FWHM 42.0°
 Efficiency 88 %
 Peak intensity 1.300 cd/lm
 Required components:

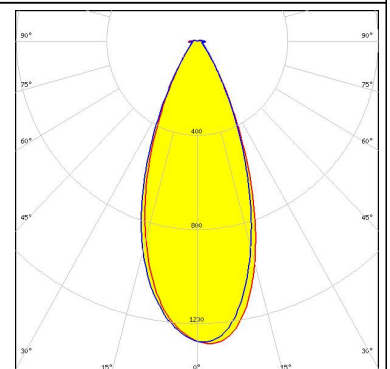
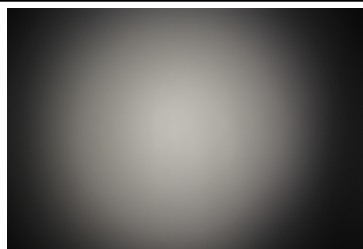

PHOTOMETRIC DATA (MEASURED):



LED NVSxx19A
FWHM 48.0°
Efficiency 79 %
Peak intensity 0.910 cd/lm
Required components:



LED NVSxx19B/NVSxx19C
FWHM 44.0°
Efficiency 77 %
Peak intensity 1.200 cd/lm
Required components:

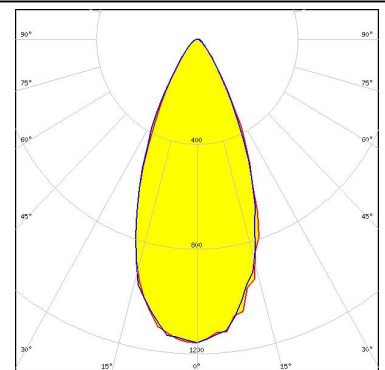
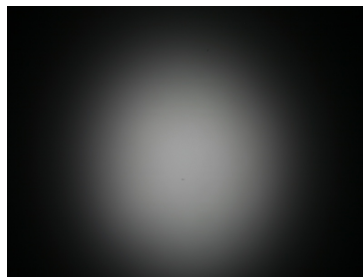

LED Oslon SSL 150
FWHM 40.0°
Efficiency 81 %
Peak intensity 1.210 cd/lm
Required components:



LED Oslon SSL 80
FWHM 47.0°
Efficiency 80 %
Peak intensity 1.000 cd/lm
Required components:

PHOTOMETRIC DATA (MEASURED):

SAMSUNG

LED LH181A
FWHM 38.0°
Efficiency 87 %
Peak intensity 1.400 cd/lm
Required components:

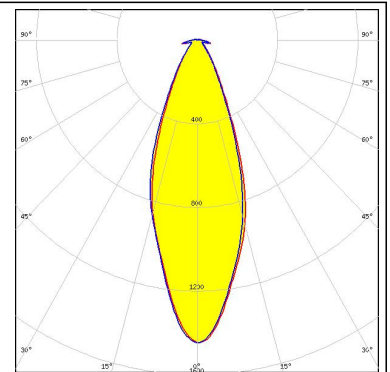
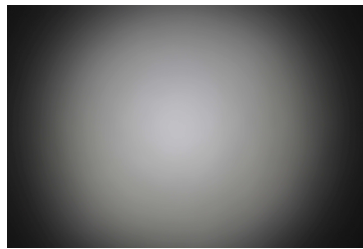

SAMSUNG

LED LH351Z
FWHM 46.0°
Efficiency 82 %
Peak intensity 1.300 cd/lm
Required components:

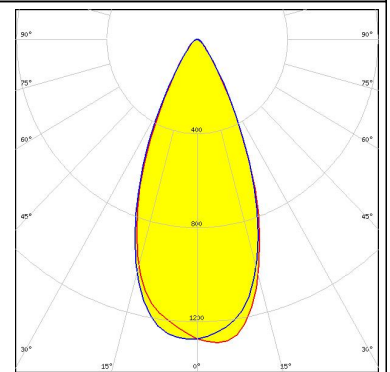
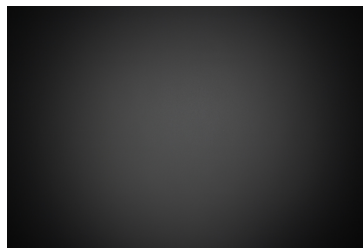

SEOUL SEMICONDUCTOR

LED Z5
FWHM 44.0°
Efficiency 76 %
Peak intensity 1.240 cd/lm
Required components:



SEOUL SEMICONDUCTOR

LED Z5M1/Z5M2
FWHM 44.0°
Efficiency 83 %
Peak intensity 1.320 cd/lm
Required components:

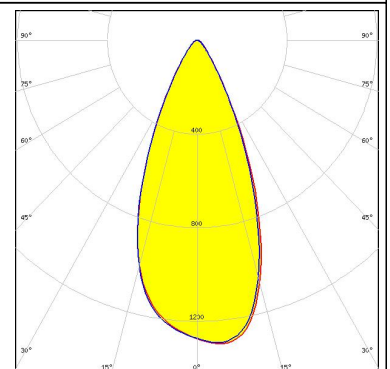
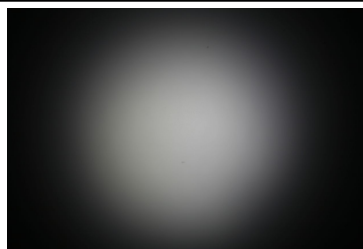

PHOTOMETRIC DATA (MEASURED):

SHARP

LED Double Dome (GM2BB)

FWHM 44.0°

Efficiency %

Peak intensity cd/lm

Required components:

PHOTOMETRIC DATA (SIMULATED):



LED LUXEON Z ES
FWHM 43.0°
Efficiency 94 %
Peak intensity 1.720 cd/lm
Required components:

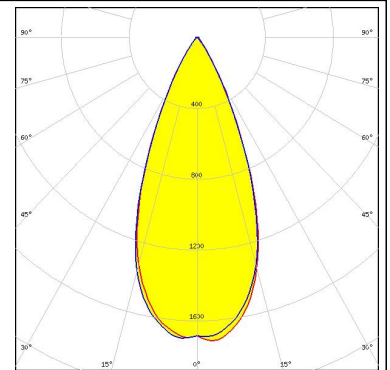

LED Oslon Square EC
FWHM 48.0°
Efficiency 94 %
Peak intensity 1.600 cd/lm
Required components:

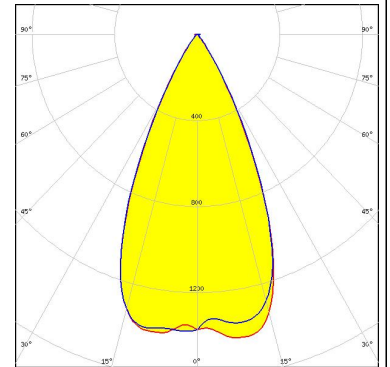
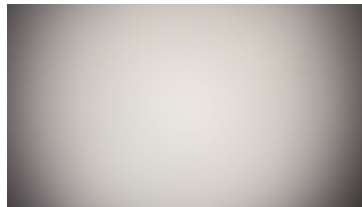

GENERAL INFORMATION:

NOTE: The typical beam angle will be changed by different color, chip size and chip position tolerance. The typical total beam angle is the full angle measured where the luminous intensity is half of the peak value.

MATERIALS:

As part of our continuous research and improvement processes, and to ensure the best possible quality and availability of our products, LEDiL reserves the right to change material grades without notice.

PRODUCT DATA USER AGREEMENT AND DISCLAIMER:

The measured data in the provided downloadable LEDiL Product Datasheets and Mechanical 2D-Drawings is rounded and provided as reference for planning. LEDiL Oy's optical specifications have been verified by conducting performance testing of the products in accordance with the company's quality system. The reported data are averaged results of multiple measurements with typical variation. LEDiL Oy reserves the right to without prior notification make changes and improvements to its products.

LEDiL Oy assumes neither warranty, nor guarantee nor any other liability of any kind for the contents and correctness of the provided data. The provided data has been generated with highest diligence but the provided data may in reality not represent the complete possible variation range of all intrinsic parameters. Therefore, in certain cases a deviation from the provided data could occur.

LEDiL Oy reserves the right to undertake technical changes of its products without further notification which could lead to changes in the provided data. LEDiL Oy assumes no liability of any kind for the possible deviation from any provided data or any other damage resulting from the usage of the provided data.

The user agrees to this disclaimer and user agreement with the download or usage of the provided files.

LEDiL Oy

Joensuunkatu 13
FI-24240 SALO
Finland

LEDiL Inc.

228 West Page Street
Suite D
Sycamore IL 60178
USA

Local sales and technical support

[www.ledil.com/
where_to_buy](http://www.ledil.com/where_to_buy)

Shipping locations

Salo, Finland
Hong Kong, China

Distribution Partners

[www.ledil.com/
where_to_buy](http://www.ledil.com/where_to_buy)