

LXP2-M

~25° medium beam optimized for CREE XP-E.
14.7 mm high assembly with installation tape.

TECHNICAL SPECIFICATIONS:

Dimensions	Ø 21.6 mm
Height	14.7 mm
Fastening	tape
Colour	black
Box size	480 x 280 x 300 mm
Box weight	9 kg
Quantity in Box	1680 pcs
ROHS compliant	yes ⓘ



MATERIAL SPECIFICATIONS:

Component	Type	Material	Colour
LXP2-M	Lens	PMMA	clear
LXP2-LH1-TAPE-BLK	Holder	PC	black
HEIDI-TAPE	Tape	PU tape	black

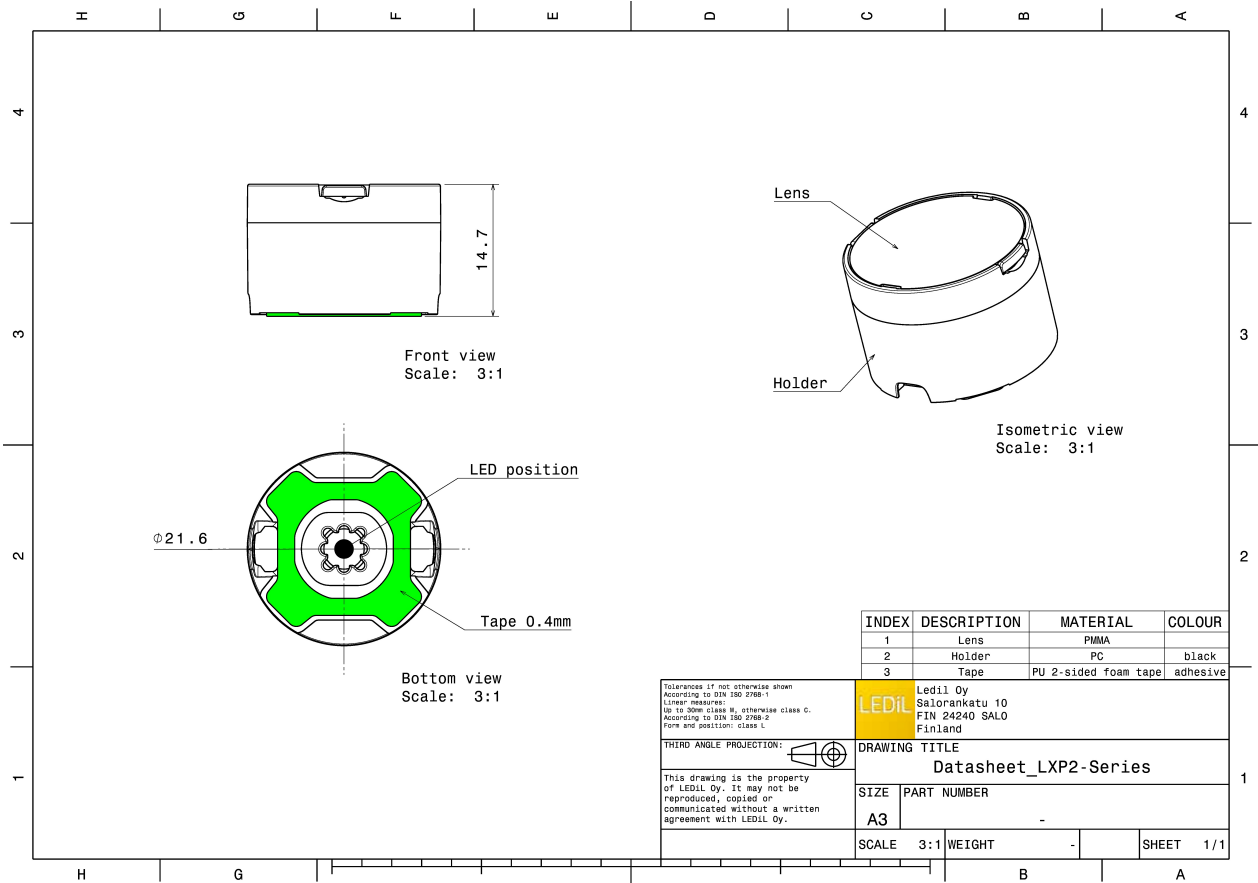

PHOTOMETRIC DATA (MEASURED):

CREE

LED XP-E
FWHM 23.0°
Efficiency 94 %
Peak intensity 4.600 cd/lm
Required components:

CREE

LED XP-E-HEW
FWHM 23.0°
Efficiency 93 %
Peak intensity cd/lm
Required components:

CREE

LED XP-E2
FWHM 23.0°
Efficiency 88 %
Peak intensity 5.200 cd/lm
Required components:

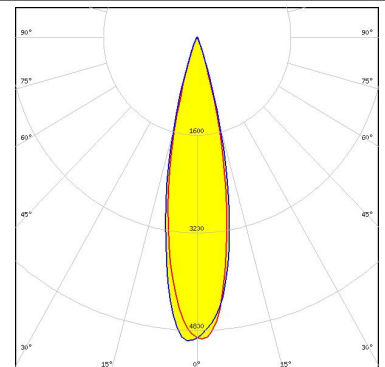
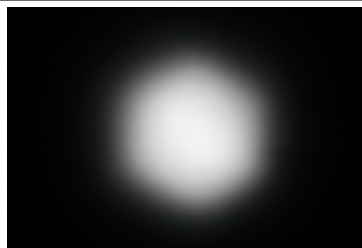

CREE

LED XP-G
FWHM 24.0°
Efficiency 94 %
Peak intensity cd/lm
Required components:

PHOTOMETRIC DATA (MEASURED):



LED XP-G2
 FWHM 23.0°
 Efficiency 90 %
 Peak intensity 5.000 cd/lm
 Required components:

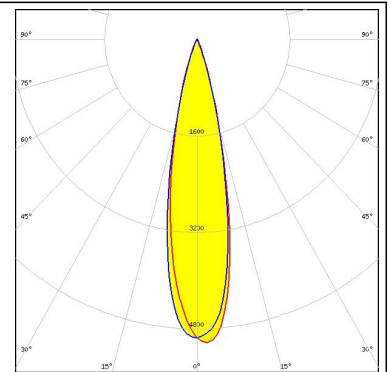
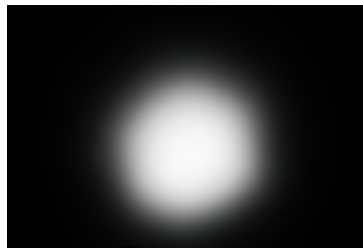

LED XP-L HI
 FWHM 24.0°
 Efficiency 87 %
 Peak intensity 4.700 cd/lm
 Required components:

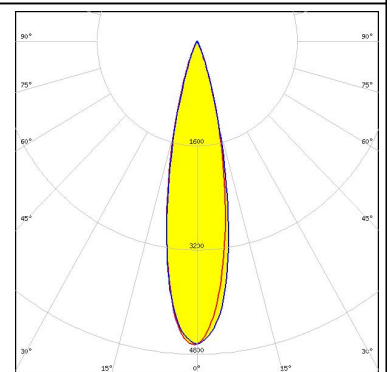

LED XT-E
 FWHM 24.0°
 Efficiency 88 %
 Peak intensity 3.900 cd/lm
 Required components:

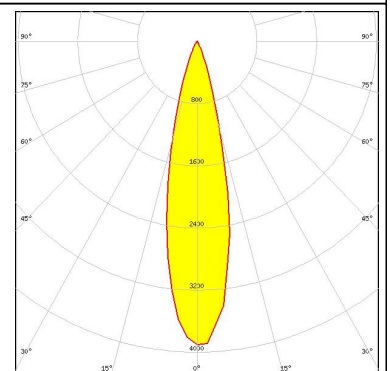

LED H35B0 (LEMWA32)
 FWHM 24.0°
 Efficiency 90 %
 Peak intensity 4.900 cd/lm
 Required components:

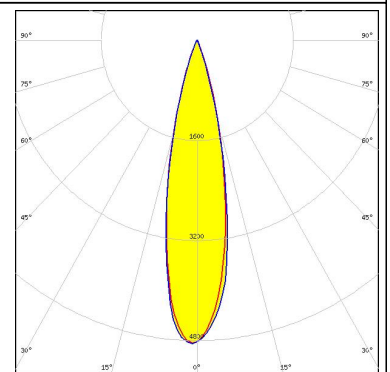

PHOTOMETRIC DATA (MEASURED):



LED H35C1 (LEMWA33)
FWHM 25.0°
Efficiency 87 %
Peak intensity 4.600 cd/lm
Required components:

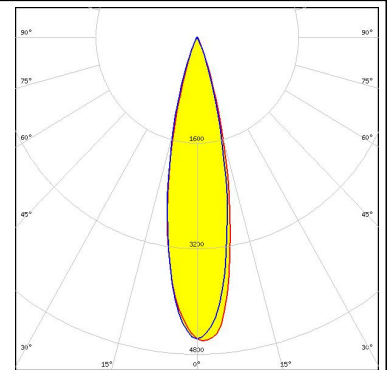
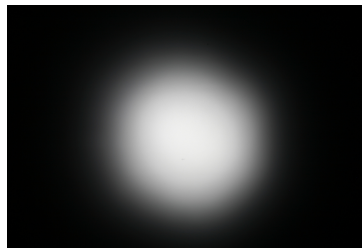

LED LUXEON Q
FWHM 24.0°
Efficiency 87 %
Peak intensity 4.300 cd/lm
Required components:

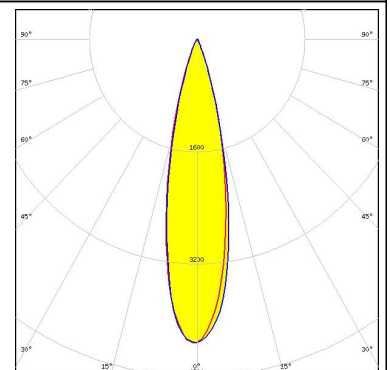

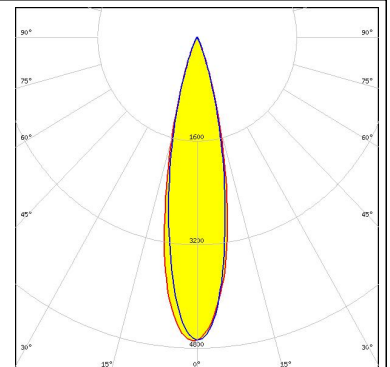
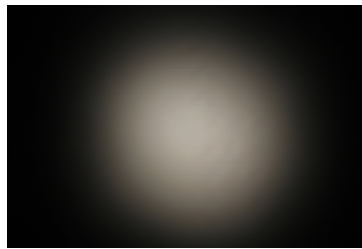

LED NVSW219D
FWHM 24.0°
Efficiency 89 %
Peak intensity 4.700 cd/lm
Required components:

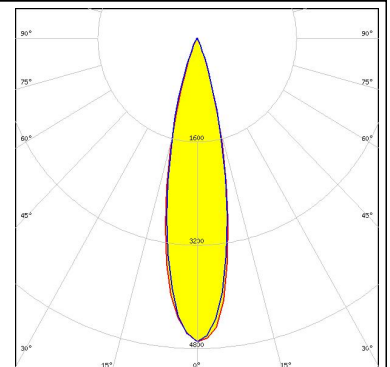
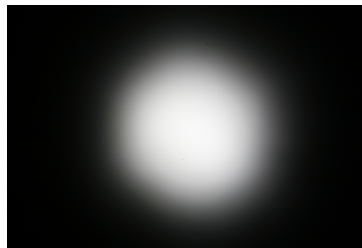

LED Z5M1/Z5M2
FWHM 26.0°
Efficiency 87 %
Peak intensity 4.700 cd/lm
Required components:

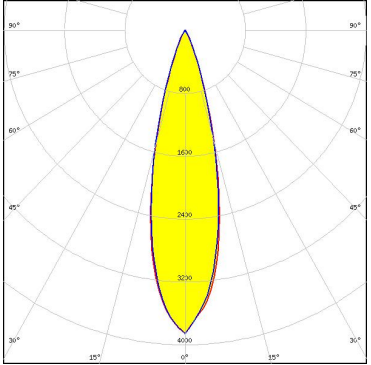

PHOTOMETRIC DATA (SIMULATED):

 SEOUL SEMICONDUCTOR	
LED	Z5
FWHM	25.0°
Efficiency	%
Peak intensity	cd/lm
Required components:	
 SEOUL SEMICONDUCTOR	
LED	Z8Y22P
FWHM	26.0°
Efficiency	89 %
Peak intensity	3.860 cd/lm
Required components:	
	

GENERAL INFORMATION:

NOTE: The typical beam angle will be changed by different color, chip size and chip position tolerance. The typical total beam angle is the full angle measured where the luminous intensity is half of the peak value.

MATERIALS:

As part of our continuous research and improvement processes, and to ensure the best possible quality and availability of our products, LEDiL reserves the right to change material grades without notice.

PRODUCT DATA USER AGREEMENT AND DISCLAIMER:

The measured data in the provided downloadable LEDiL Product Datasheets and Mechanical 2D-Drawings is rounded and provided as reference for planning. LEDiL Oy's optical specifications have been verified by conducting performance testing of the products in accordance with the company's quality system. The reported data are averaged results of multiple measurements with typical variation. LEDiL Oy reserves the right to without prior notification make changes and improvements to its products.

LEDiL Oy assumes neither warranty, nor guarantee nor any other liability of any kind for the contents and correctness of the provided data. The provided data has been generated with highest diligence but the provided data may in reality not represent the complete possible variation range of all intrinsic parameters. Therefore, in certain cases a deviation from the provided data could occur.

LEDiL Oy reserves the right to undertake technical changes of its products without further notification which could lead to changes in the provided data. LEDiL Oy assumes no liability of any kind for the possible deviation from any provided data or any other damage resulting from the usage of the provided data.

The user agrees to this disclaimer and user agreement with the download or usage of the provided files.

LEDiL Oy

Joensuunkatu 13
FI-24240 SALO
Finland

LEDiL Inc.

228 West Page Street
Suite D
Sycamore IL 60178
USA

Local sales and technical support

[www.ledil.com/
where_to_buy](http://www.ledil.com/where_to_buy)

Shipping locations

Salo, Finland
Hong Kong, China

Distribution Partners

[www.ledil.com/
where_to_buy](http://www.ledil.com/where_to_buy)