

HEIDI-O

~50° x 11° oval beam

TECHNICAL SPECIFICATIONS:

Dimensions	Ø 21.6 mm
Height	11.7 mm
Fastening	pin, tape
Colour	clear
Box size	480 x 280 x 300 mm
Box weight	9.7 kg
Quantity in Box	3264 pcs
ROHS compliant	yes ⓘ



MATERIAL SPECIFICATIONS:

Component	Type	Material	Colour
HEIDI-O	Lens	PMMA	clear
HEIDI-TAPE	Tape	PU tape	black

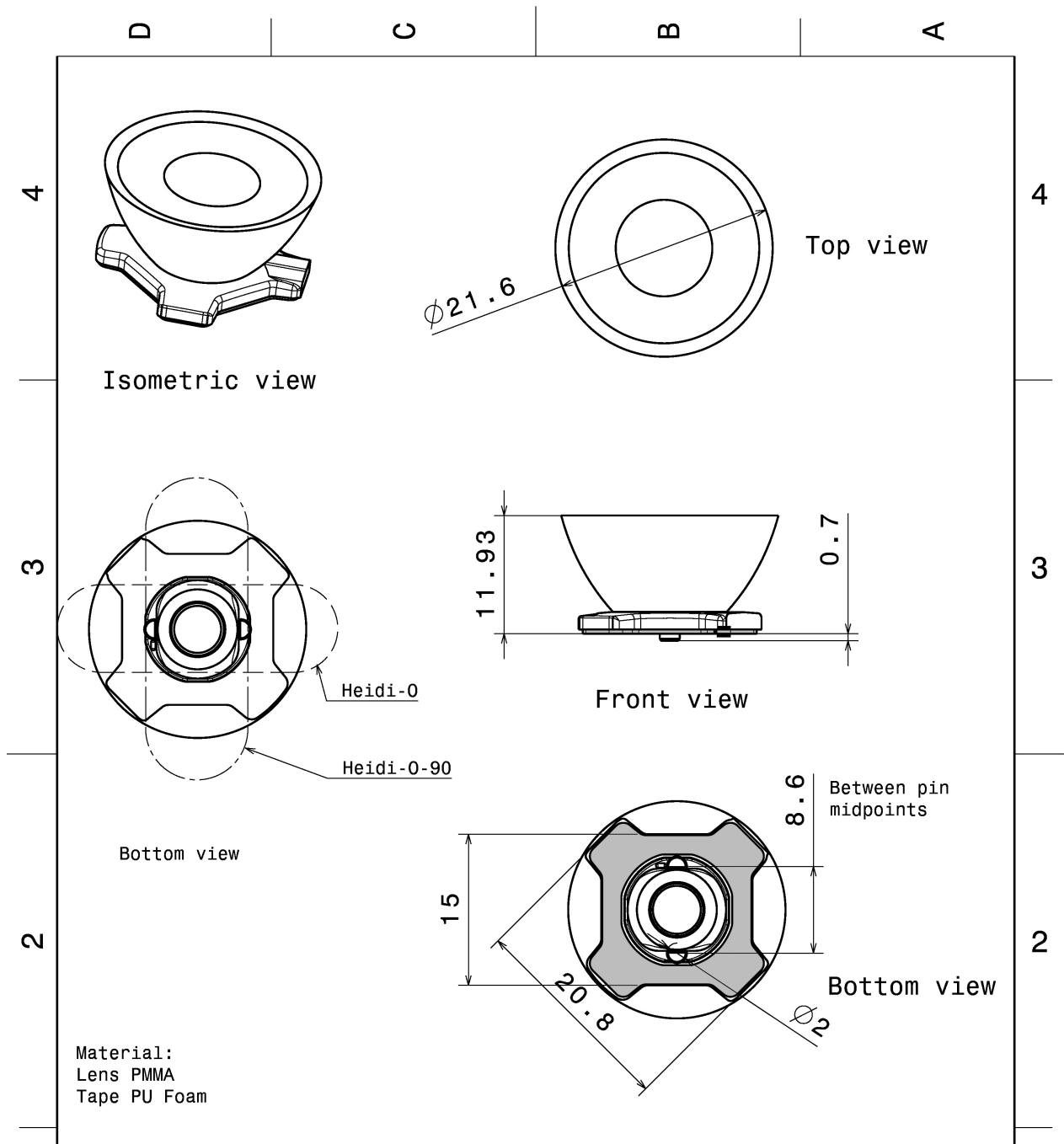

This drawing is our property. It can't be reproduced or communicated without our written agreement.		LEDiL A WORLD OF INNOVATION		Ledil Oy Salorankatu 10 FIN-24100 SALO Finland	
DRAWN BY ah		DATE 24.6.2013		DRAWING TITLE Datasheet Heidi-0 assy	
CHECKED BY	DATE	SIZE A4	DRAWING NUMBER		
DESIGNED BY	DATE	SCALE 2:1	WEIGHT (g)	SHEET 1/1	

PHOTOMETRIC DATA (MEASURED):

CREE

LED XB-D
 FWHM 54.0 + 10.0°
 Efficiency 87 %
 Peak intensity 3.900 cd/lm
 Required components:

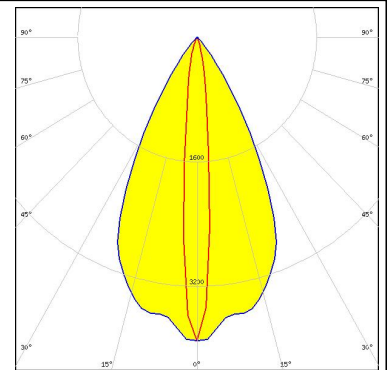

CREE

LED XB-H
 FWHM 53.0 + 11.0°
 Efficiency 83 %
 Peak intensity 3.300 cd/lm
 Required components:

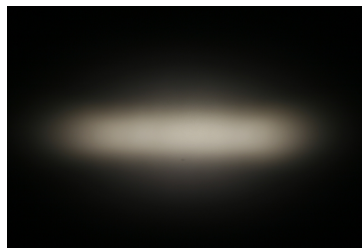

CREE

LED XD16
 FWHM 52.0 + 10.0°
 Efficiency 89 %
 Peak intensity 3.200 cd/lm
 Required components:

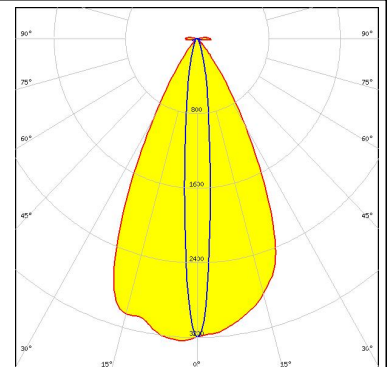
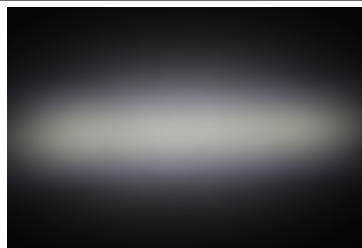

CREE

LED XP-E
 FWHM 48.0 + 10.0°
 Efficiency 87 %
 Peak intensity 4.100 cd/lm
 Required components:

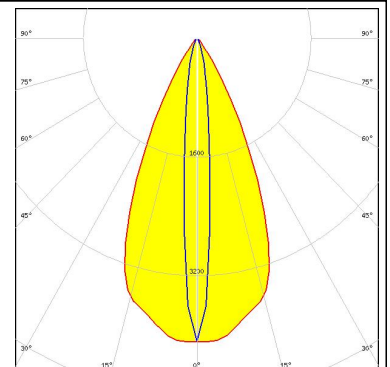

PHOTOMETRIC DATA (MEASURED):



LED XP-E2
 FWHM 54.0 + 9.0°
 Efficiency 85 %
 Peak intensity 4.800 cd/lm
 Required components:

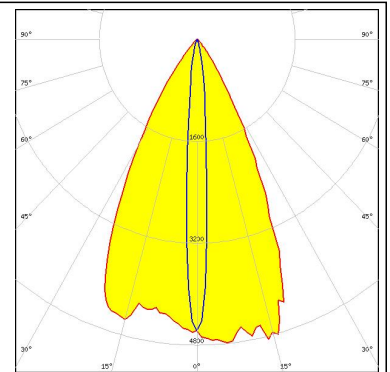
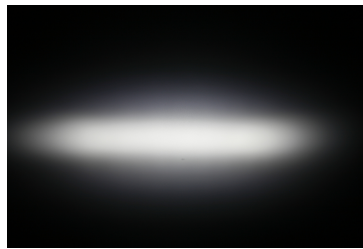

LED XP-G
 FWHM 47.0 + 14.0°
 Efficiency 87 %
 Peak intensity 3.300 cd/lm
 Required components:

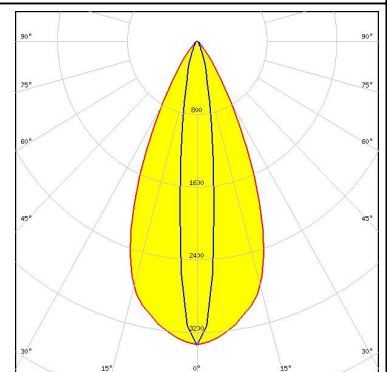

LED XP-G2
 FWHM 52.0 + 11.0°
 Efficiency 91 %
 Peak intensity 3.500 cd/lm
 Required components:

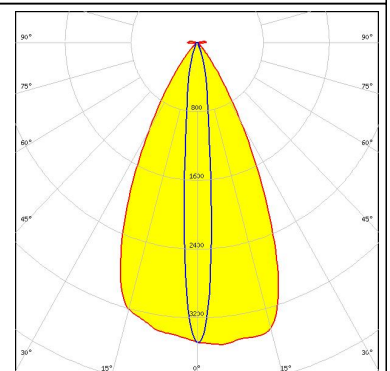
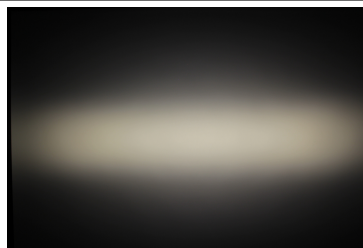

LED XP-G3
 FWHM 51.0 + 13.0°
 Efficiency 91 %
 Peak intensity 3.000 cd/lm
 Required components:

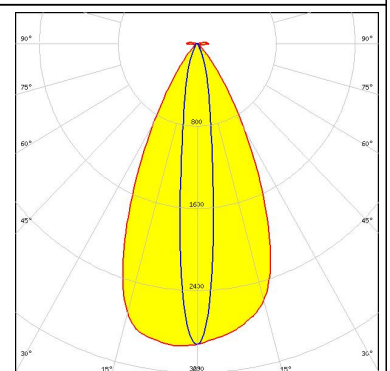
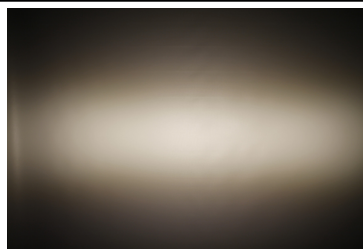

PHOTOMETRIC DATA (MEASURED):



LED XQ-E HI
 FWHM 53.0 + 7.0°
 Efficiency 90 %
 Peak intensity 4.500 cd/lm
 Required components:

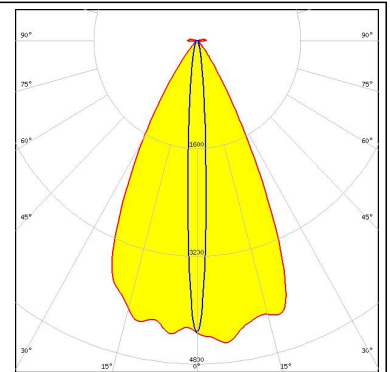

LED LUXEON C
 FWHM 53.0 + 9.0°
 Efficiency 81 %
 Peak intensity 4.100 cd/lm
 Required components:

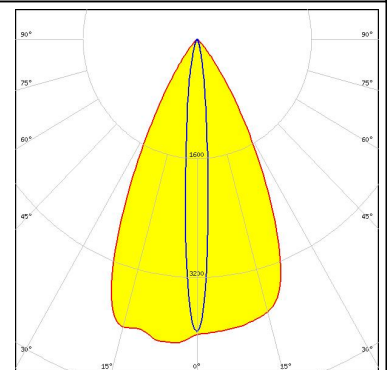
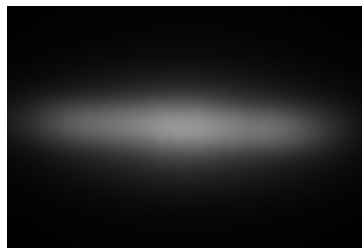

LED LUXEON CZ
 FWHM 53.0 + 7.0°
 Efficiency 92 %
 Peak intensity 5.200 cd/lm
 Required components:

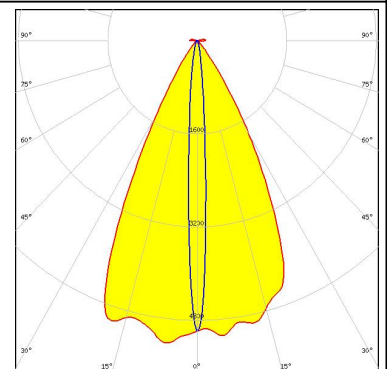
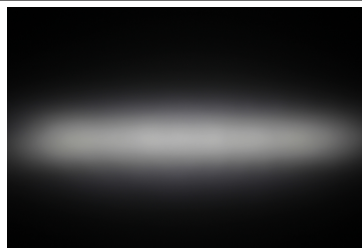

LED LUXEON T
 FWHM 52.0 + 12.0°
 Efficiency 81 %
 Peak intensity 3.200 cd/lm
 Required components:

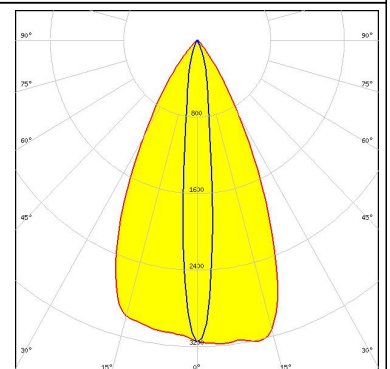
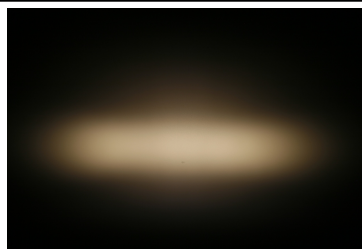

PHOTOMETRIC DATA (MEASURED):

LUMILEDS

LED LUXEON TX
 FWHM 54.0 + 12.0°
 Efficiency 82 %
 Peak intensity 3.500 cd/lm
 Required components:

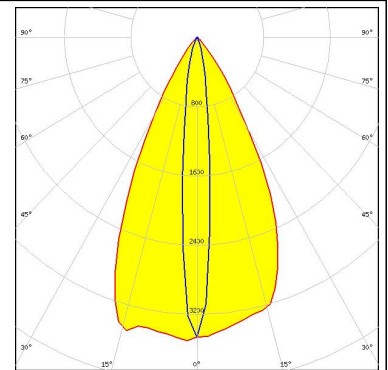

LUMILEDS

LED LUXEON Z
 FWHM 55.0 + 7.5°
 Efficiency 87 %
 Peak intensity 4.900 cd/lm
 Required components:

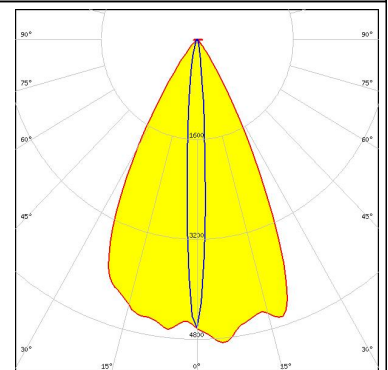
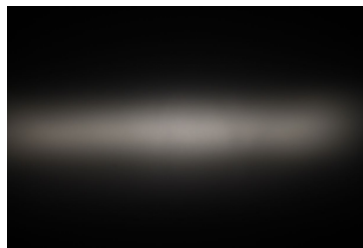

LUMILEDS

LED LUXEON Z ES
 FWHM 54.0 + 9.6°
 Efficiency 85 %
 Peak intensity 3.800 cd/lm
 Required components:

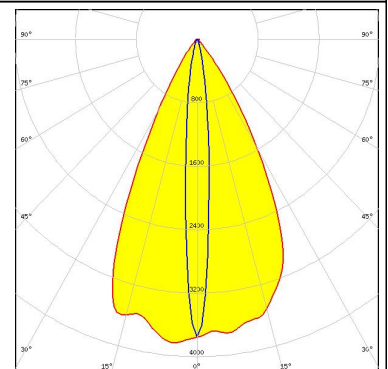
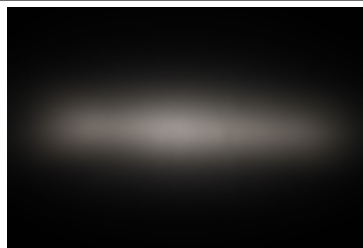

NICHIA

LED NCSxx19A
 FWHM 46.0 + 12.0°
 Efficiency 82 %
 Peak intensity 3.300 cd/lm
 Required components:

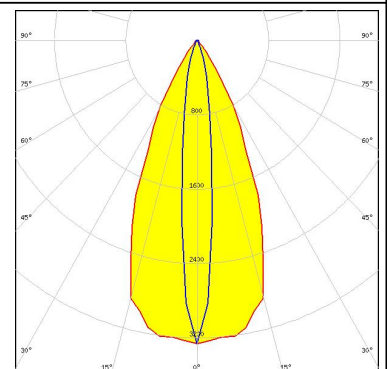

PHOTOMETRIC DATA (MEASURED):



LED NCSxx19B
 FWHM 55.0 + 11.0°
 Efficiency 83 %
 Peak intensity 3.600 cd/lm
 Required components:

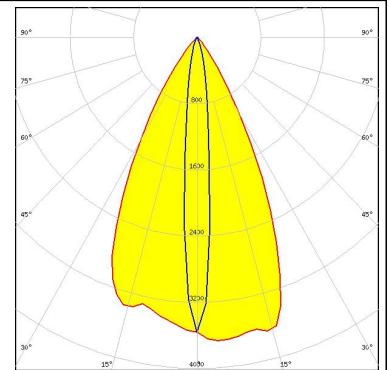

LED NVSxx19A
 FWHM 50.0 + 12.0°
 Efficiency 82 %
 Peak intensity 3.000 cd/lm
 Required components:

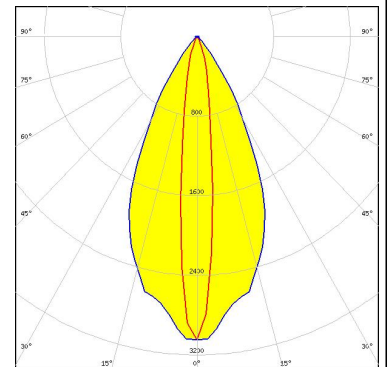

LED NVSxx19B/NVSxx19C
 FWHM 48.0 + 15.0°
 Efficiency 82 %
 Peak intensity 2.700 cd/lm
 Required components:

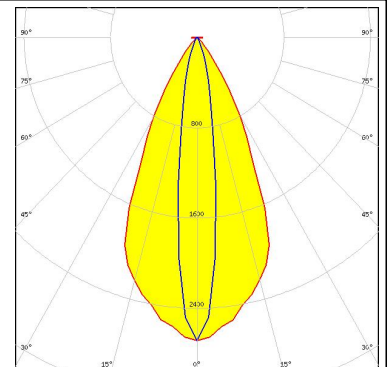
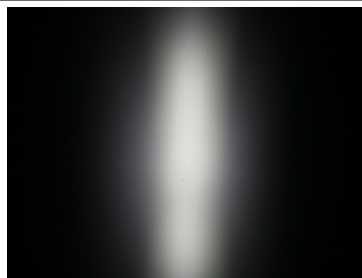

LED Oslon Square EC
 FWHM 48.0 + 12.0°
 Efficiency 86 %
 Peak intensity 3.500 cd/lm
 Required components:

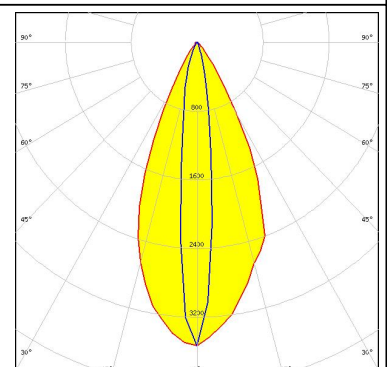

PHOTOMETRIC DATA (MEASURED):

OSRAM
Opto Semiconductors

LED Oslon Square Gen3
 FWHM 52.0 + 13.0°
 Efficiency 80 %
 Peak intensity 3.670 cd/lm
 Required components:

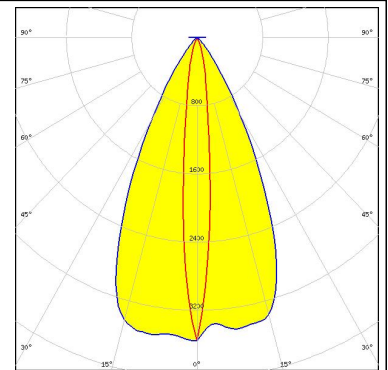

OSRAM
Opto Semiconductors

LED Oslon SSL 150
 FWHM 50.0 + 8.0°
 Efficiency 85 %
 Peak intensity 4.500 cd/lm
 Required components:

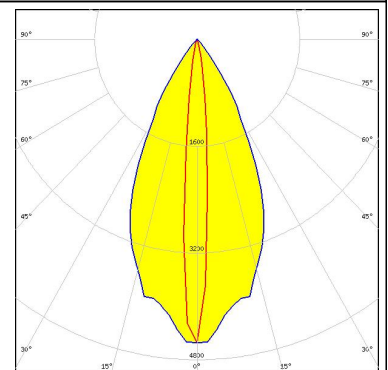

OSRAM
Opto Semiconductors

LED Oslon SSL 80
 FWHM 47.0 + 8.0°
 Efficiency 83 %
 Peak intensity 4.100 cd/lm
 Required components:

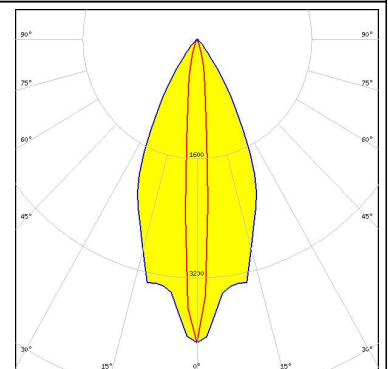

SAMSUNG

LED LH181B
 FWHM 53.0 + 13.0°
 Efficiency 90 %
 Peak intensity 2.900 cd/lm
 Required components:

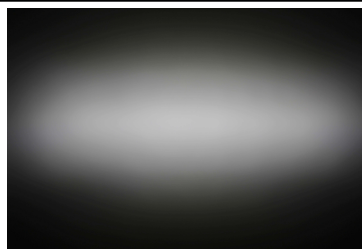

PHOTOMETRIC DATA (MEASURED):

SAMSUNG

LED LH351B
 FWHM 51.0 + 13.0°
 Efficiency 84 %
 Peak intensity 3.000 cd/lm
 Required components:

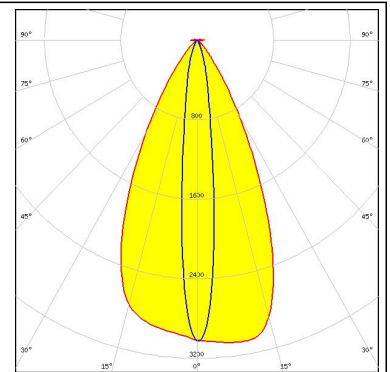
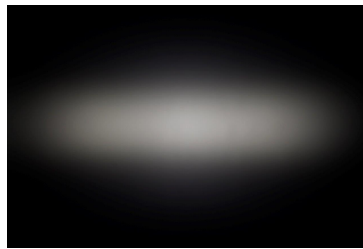

SAMSUNG

LED LH351Z
 FWHM 54.0 + 12.0°
 Efficiency 83 %
 Peak intensity 3.600 cd/lm
 Required components:

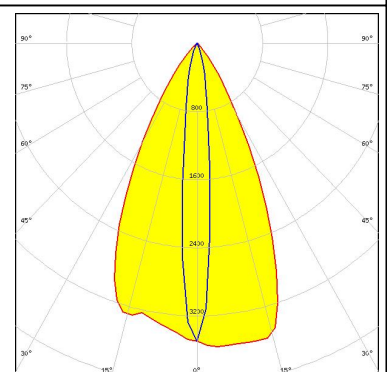
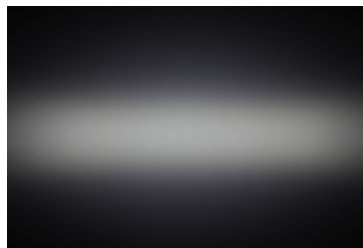

SEOUL SEMICONDUCTOR

LED Z5
 FWHM 50.0 + 9.0°
 Efficiency 86 %
 Peak intensity 4.800 cd/lm
 Required components:

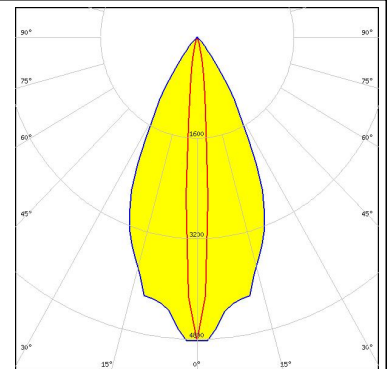

SEOUL SEMICONDUCTOR

LED Z5M1/Z5M2
 FWHM 53.0 + 11.0°
 Efficiency 85 %
 Peak intensity 3.500 cd/lm
 Required components:

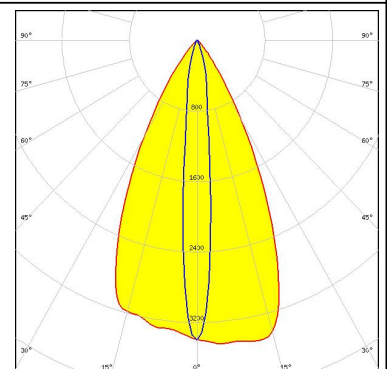

PHOTOMETRIC DATA (MEASURED):

SHARP

LED Double Dome (GM2BB)

FWHM 50.0 + 16.0°

Efficiency 85 %

Peak intensity 2.500 cd/lm

Required components:

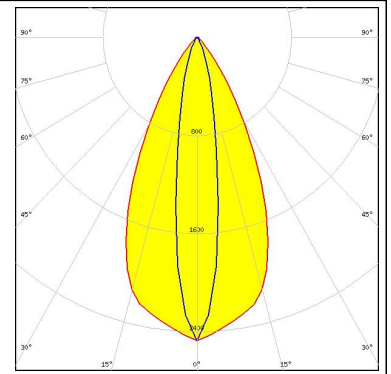

PHOTOMETRIC DATA (SIMULATED):

LG Innotek

LED H35C0 (LEMWA33)
FWHM 49.0 + 12.0°
Efficiency 79 %
Peak intensity 3.130 cd/lm
Required components:

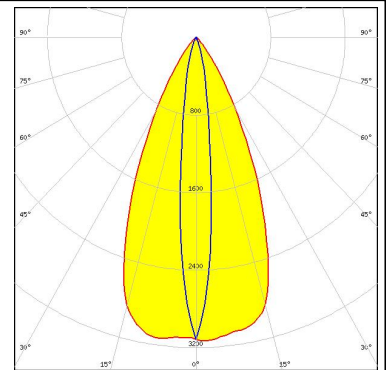

NICHIA

LED NF2x757G
FWHM 54.0 + 12.0°
Efficiency 91 %
Peak intensity 3.280 cd/lm
Required components:

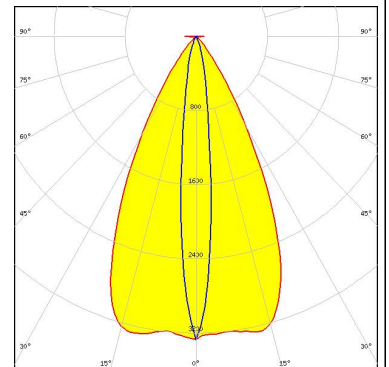

NICHIA

LED NFSx757G
FWHM 54.0 + 10.0°
Efficiency 0 %
Peak intensity 3.720 cd/lm
Required components:

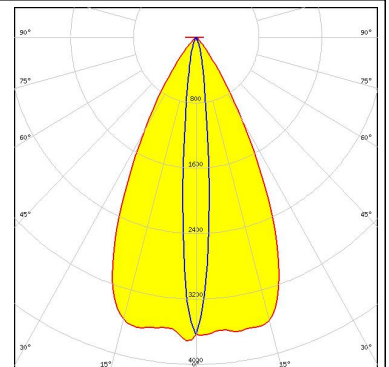

OSRAM Opto Semiconductors

LED Oslon Black Flat
FWHM 49.7 + 7.8°
Efficiency 93 %
Peak intensity 4.990 cd/lm
Required components:

GENERAL INFORMATION:

NOTE: The typical beam angle will be changed by different color, chip size and chip position tolerance. The typical total beam angle is the full angle measured where the luminous intensity is half of the peak value.

MATERIALS:

As part of our continuous research and improvement processes, and to ensure the best possible quality and availability of our products, LEDiL reserves the right to change material grades without notice.

PRODUCT DATA USER AGREEMENT AND DISCLAIMER:

The measured data in the provided downloadable LEDiL Product Datasheets and Mechanical 2D-Drawings is rounded and provided as reference for planning. LEDiL Oy's optical specifications have been verified by conducting performance testing of the products in accordance with the company's quality system. The reported data are averaged results of multiple measurements with typical variation. LEDiL Oy reserves the right to without prior notification make changes and improvements to its products.

LEDiL Oy assumes neither warranty, nor guarantee nor any other liability of any kind for the contents and correctness of the provided data. The provided data has been generated with highest diligence but the provided data may in reality not represent the complete possible variation range of all intrinsic parameters. Therefore, in certain cases a deviation from the provided data could occur.

LEDiL Oy reserves the right to undertake technical changes of its products without further notification which could lead to changes in the provided data. LEDiL Oy assumes no liability of any kind for the possible deviation from any provided data or any other damage resulting from the usage of the provided data.

The user agrees to this disclaimer and user agreement with the download or usage of the provided files.

LEDiL Oy

Joensuunkatu 13
FI-24240 SALO
Finland

LEDiL Inc.

228 West Page Street
Suite D
Sycamore IL 60178
USA

Local sales and technical support

[www.ledil.com/
where_to_buy](http://www.ledil.com/where_to_buy)

Shipping locations

Salo, Finland
Hong Kong, China

Distribution Partners

[www.ledil.com/
where_to_buy](http://www.ledil.com/where_to_buy)