

HEIDI-D

~10° diffused spot beam

TECHNICAL SPECIFICATIONS:

Dimensions	Ø 21.6 mm
Height	11.7 mm
Fastening	pin, tape
Colour	clear
Box size	480 x 280 x 300 mm
Box weight	10.6 kg
Quantity in Box	3264 pcs
ROHS compliant	yes ⓘ



MATERIAL SPECIFICATIONS:

Component	Type	Material	Colour
HEIDI-D	Lens	PMMA	clear
HEIDI-TAPE	Tape	PU tape	black

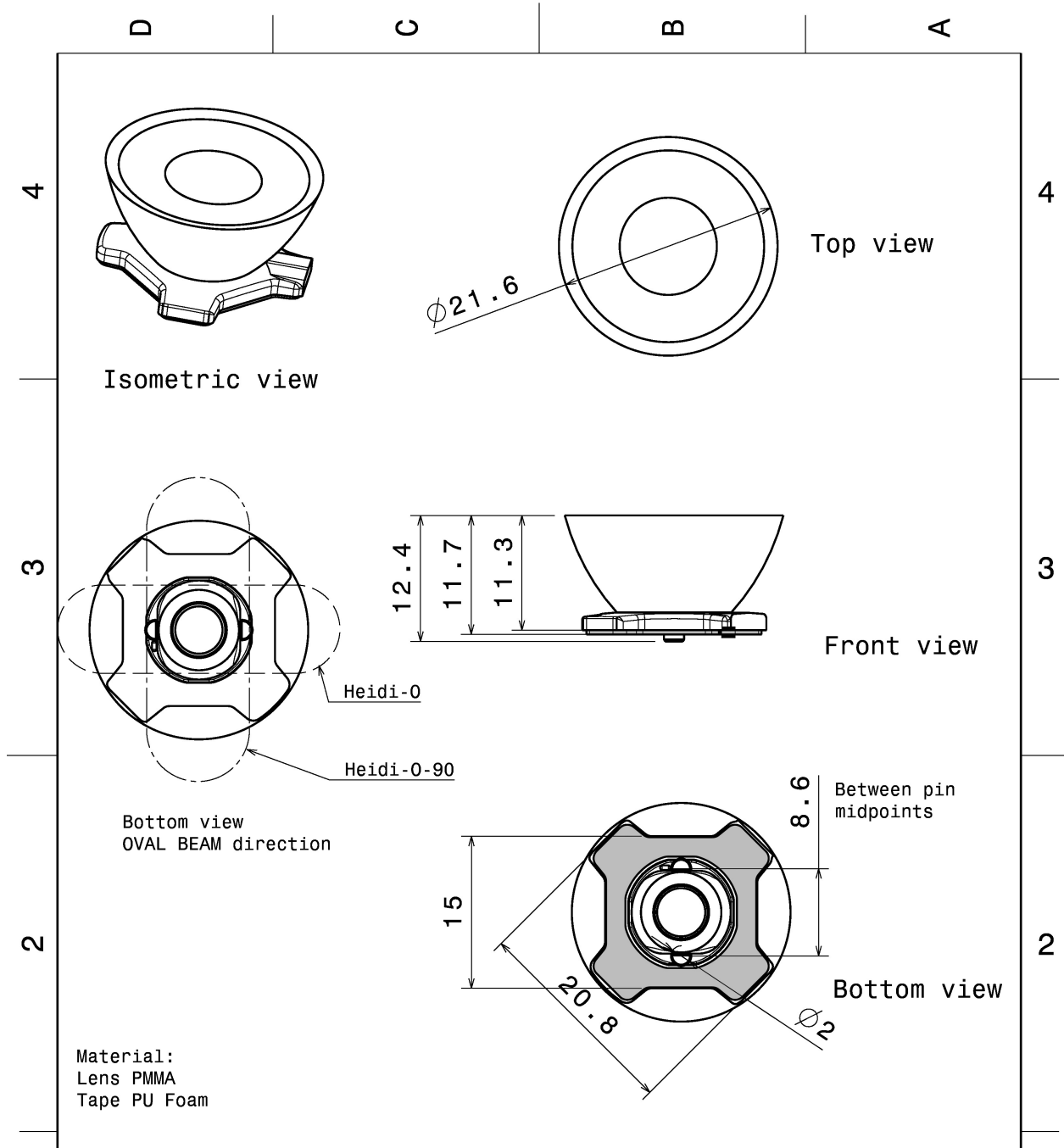

This drawing is our property. It can't be reproduced or communicated without our written agreement.		LEDiL		Ledil Oy Salorankatu 10 FIN-24100 SALO Finland	
DRAWING TITLE		Datasheet Heidi-Series Assy			
DRAWN BY	DATE	SIZE	DRAWING NUMBER		REV
ah	1.2.2012	A4			2
CHECKED BY	DATE	SCALE	2:1	WEIGHT (g)	SHEET
DESIGNED BY	DATE				1/1

PHOTOMETRIC DATA (MEASURED):

CREE

LED XB-D
FWHM 10.0°
Efficiency 90 %
Peak intensity 12.550 cd/lm
Required components:

CREE

LED XB-H
FWHM 11.0°
Efficiency 87 %
Peak intensity 12.700 cd/lm
Required components:



CREE

LED XD16
FWHM 10.0°
Efficiency 93 %
Peak intensity 14.100 cd/lm
Required components:

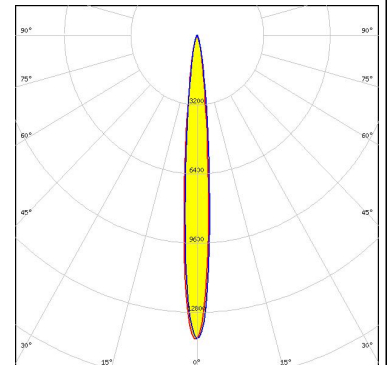

CREE

LED XP-E
FWHM 9.0°
Efficiency 93 %
Peak intensity 22.000 cd/lm
Required components:

PHOTOMETRIC DATA (MEASURED):



LED XP-E2
 FWHM 10.0°
 Efficiency 88 %
 Peak intensity 17.400 cd/lm
 Required components:

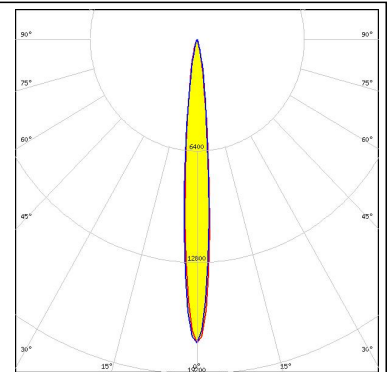
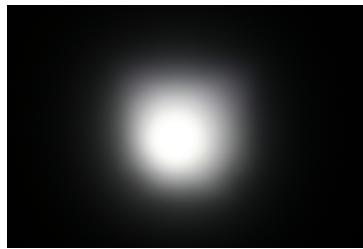

LED XP-G
 FWHM 12.0°
 Efficiency 93 %
 Peak intensity 14.500 cd/lm
 Required components:

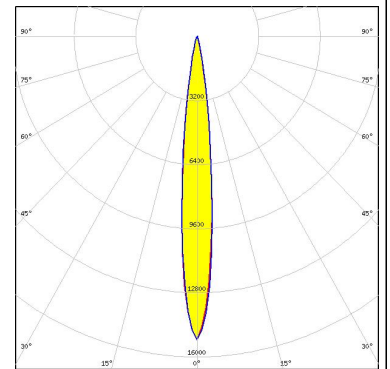

LED XP-G2
 FWHM 11.0°
 Efficiency 88 %
 Peak intensity 15.000 cd/lm
 Required components:

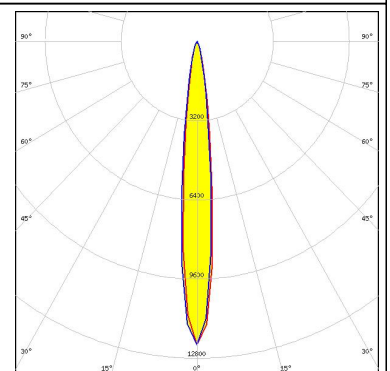
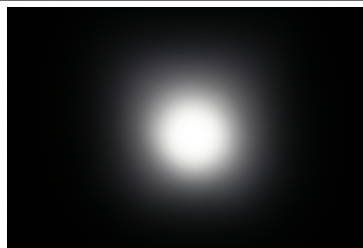

LED XQ-E HI
 FWHM 7.0°
 Efficiency 93 %
 Peak intensity 24.800 cd/lm
 Required components:

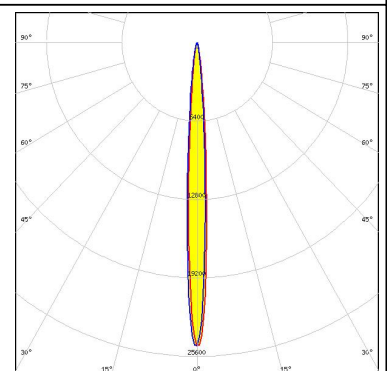

PHOTOMETRIC DATA (MEASURED):



LED XT-E
 FWHM 10.0°
 Efficiency 90 %
 Peak intensity 14.300 cd/lm
 Required components:

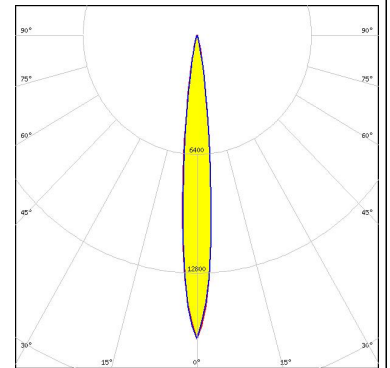
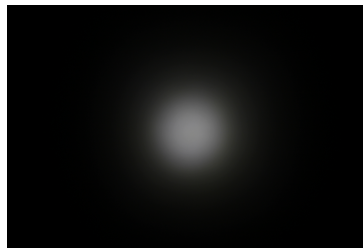

LED LUXEON C
 FWHM 9.0°
 Efficiency 89 %
 Peak intensity 17.800 cd/lm
 Required components:

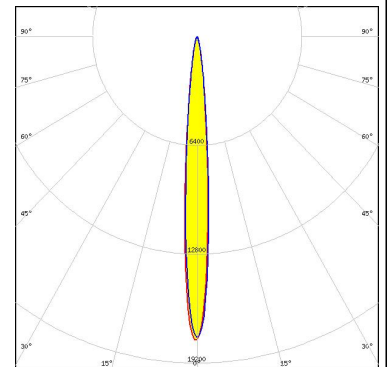

LED LUXEON CZ
 FWHM 7.0°
 Efficiency 94 %
 Peak intensity 29.000 cd/lm
 Required components:

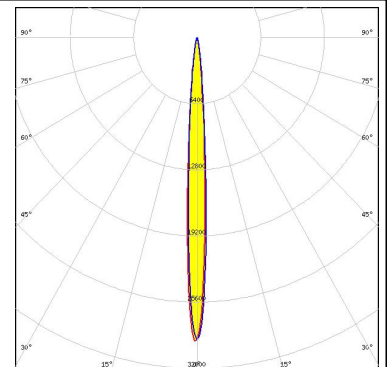
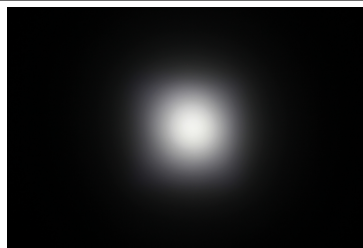

LED LUXEON T
 FWHM 12.0°
 Efficiency 89 %
 Peak intensity 11.500 cd/lm
 Required components:

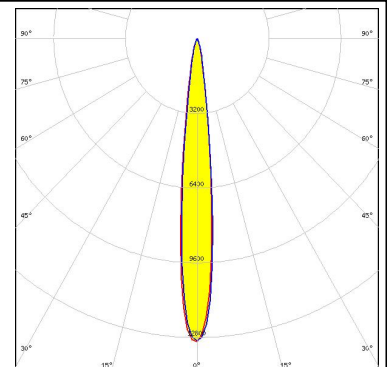

PHOTOMETRIC DATA (MEASURED):



LED LUXEON TX
FWHM 12.0°
Efficiency 88 %
Peak intensity 13.600 cd/lm
Required components:

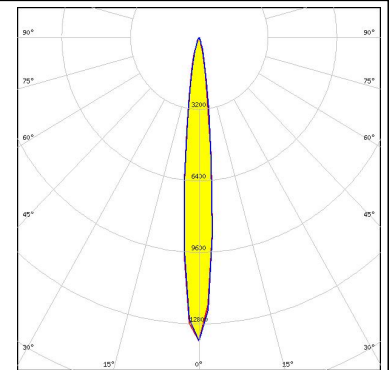

LED NCSxx19A
FWHM 9.0°
Efficiency 88 %
Peak intensity 11.900 cd/lm
Required components:



LED NCSxx19B
FWHM 11.0°
Efficiency 85 %
Peak intensity 14.200 cd/lm
Required components:

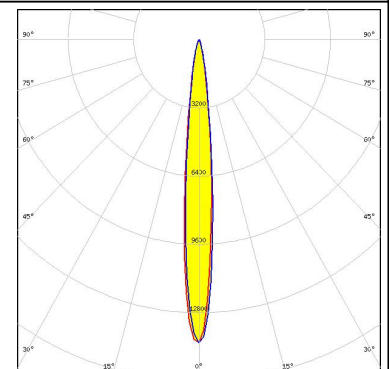
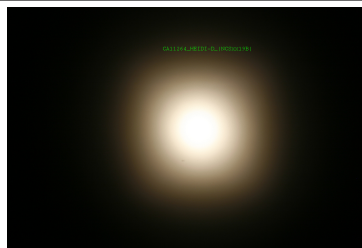

LED NVSxx19A
FWHM 12.0°
Efficiency 88 %
Peak intensity 8.900 cd/lm
Required components:

PHOTOMETRIC DATA (MEASURED):



LED NVSxx19B/NVSxx19C
FWHM 14.0°
Efficiency 91 %
Peak intensity 10.000 cd/Im
Required components:

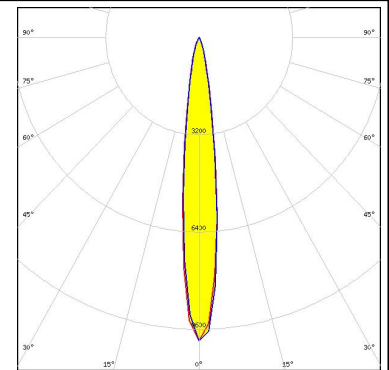

LED Oslon Square EC
FWHM 10.0°
Efficiency 90 %
Peak intensity 12.900 cd/Im
Required components:



LED Oslon SSL 150
FWHM 9.0°
Efficiency 92 %
Peak intensity 15.000 cd/Im
Required components:



LED Oslon SSL 80
FWHM 7.0°
Efficiency 89 %
Peak intensity 19.300 cd/Im
Required components:

PHOTOMETRIC DATA (MEASURED):

SAMSUNG

LED LH181A
FWHM 10.0°
Efficiency 88 %
Peak intensity 10.000 cd/lm
Required components:

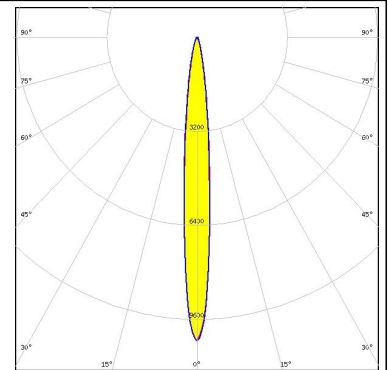

SAMSUNG

LED LH181B
FWHM 11.0°
Efficiency 94 %
Peak intensity 11.800 cd/lm
Required components:



SAMSUNG

LED LH351B
FWHM 14.0°
Efficiency 88 %
Peak intensity 10.000 cd/lm
Required components:

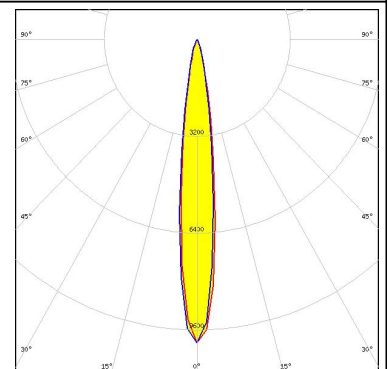
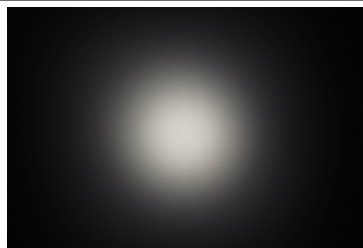

SAMSUNG

LED LH351Z
FWHM 12.0°
Efficiency 88 %
Peak intensity 13.300 cd/lm
Required components:

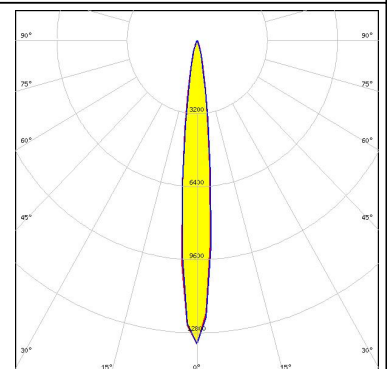

PHOTOMETRIC DATA (MEASURED):



SEOUL SEMICONDUCTOR

LED	Z5
FWHM	8.0°
Efficiency	87 %
Peak intensity	22.300 cd/lm

Required components:

PHOTOMETRIC DATA (SIMULATED):

<p>LUMILEDS</p> <p>LED LUXEON Z</p> <p>FWHM 8.5°</p> <p>Efficiency 94 %</p> <p>Peak intensity 32.403 cd/lm</p> <p>Required components:</p>	
<p>LUMILEDS</p> <p>LED LUXEON Z ES</p> <p>FWHM 7.7°</p> <p>Efficiency 94 %</p> <p>Peak intensity 33.500 cd/lm</p> <p>Required components:</p>	
<p>OSRAM Opto Semiconductors</p> <p>LED Oslon Square Gen3</p> <p>FWHM 13.0°</p> <p>Efficiency 94 %</p> <p>Peak intensity 13.300 cd/lm</p> <p>Required components:</p>	
<p>OSRAM Opto Semiconductors</p> <p>LED Oslon SSL 80</p> <p>FWHM 9.4°</p> <p>Efficiency 94 %</p> <p>Peak intensity 20.070 cd/lm</p> <p>Required components:</p>	

PHOTOMETRIC DATA (SIMULATED):



GENERAL INFORMATION:

NOTE: The typical beam angle will be changed by different color, chip size and chip position tolerance. The typical total beam angle is the full angle measured where the luminous intensity is half of the peak value.

MATERIALS:

As part of our continuous research and improvement processes, and to ensure the best possible quality and availability of our products, LEDiL reserves the right to change material grades without notice.

PRODUCT DATA USER AGREEMENT AND DISCLAIMER:

The measured data in the provided downloadable LEDiL Product Datasheets and Mechanical 2D-Drawings is rounded and provided as reference for planning. LEDiL Oy's optical specifications have been verified by conducting performance testing of the products in accordance with the company's quality system. The reported data are averaged results of multiple measurements with typical variation. LEDiL Oy reserves the right to without prior notification make changes and improvements to its products.

LEDiL Oy assumes neither warranty, nor guarantee nor any other liability of any kind for the contents and correctness of the provided data. The provided data has been generated with highest diligence but the provided data may in reality not represent the complete possible variation range of all intrinsic parameters. Therefore, in certain cases a deviation from the provided data could occur.

LEDiL Oy reserves the right to undertake technical changes of its products without further notification which could lead to changes in the provided data. LEDiL Oy assumes no liability of any kind for the possible deviation from any provided data or any other damage resulting from the usage of the provided data.

The user agrees to this disclaimer and user agreement with the download or usage of the provided files.

LEDiL Oy

Joensuunkatu 13
FI-24240 SALO
Finland

LEDiL Inc.

228 West Page Street
Suite D
Sycamore IL 60178
USA

Local sales and technical support

[www.ledil.com/
where_to_buy](http://www.ledil.com/where_to_buy)

Shipping locations

Salo, Finland
Hong Kong, China

Distribution Partners

[www.ledil.com/
where_to_buy](http://www.ledil.com/where_to_buy)