

C900AC SFTY X1-440 Y2-300, Ceramic, 1500 pF, 20%, 440 VAC (X1), 300 VAC (Y2), Y5V, Lead Spacing = 7.5mm

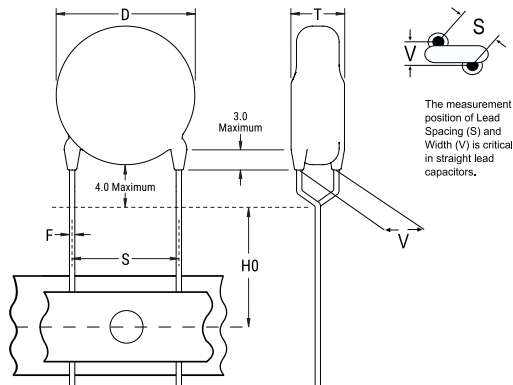

**Dimensions**

<b>D</b>	7mm MAX
<b>T</b>	5mm MAX
<b>S</b>	7.5mm +/-1mm
<b>H0</b>	18mm +2/-0mm
<b>F</b>	0.55mm +/-0.1mm

**Packaging Specifications**

<b>Weight:</b>	600 mg
<b>Packaging:</b>	Ammo
<b>Packaging Quantity:</b>	1000

**General Information**

<b>Series:</b>	C900AC SFTY X1-440 Y2-300
<b>Style:</b>	Radial Disc
<b>RoHS:</b>	Yes
<b>Termination:</b>	Tin
<b>Failure Rate:</b>	N/A
<b>Qualifications:</b>	UL, ENEC, VDE, CSA, CAN
<b>AEC-Q200:</b>	No
<b>Halogen Free:</b>	Yes

**Specifications**

<b>Capacitance:</b>	1500 pF
<b>Capacitance Tolerance:</b>	20%
<b>Voltage AC:</b>	440 VAC (X1), 300 VAC (Y2)
<b>Dielectric Withstanding Voltage:</b>	2600 VDC
<b>Temperature Range:</b>	-40/+125°C
<b>Temperature Coefficient:</b>	Y5V
<b>Dissipation Factor:</b>	5%
<b>Insulation Resistance:</b>	10 GOhms
<b>Safety Class:</b>	X1/Y2

Statements of suitability for certain applications are based on our knowledge of typical operating conditions for such applications, but are not intended to constitute - and we specifically disclaim - any warranty concerning suitability for a specific customer application or use. This Information is intended for use only by customers who have the requisite experience and capability to determine the correct products for their application. Any technical advice inferred from this Information or otherwise provided by us with reference to the use of our products is given gratis, and we assume no obligation or liability for the advice given or results obtained.