

C4AT, Film, Metallized Polypropylene, Power, 5 uF, 5%, 160 VAC, 250 VDC, 70°C, Lead Spacing = 27.5mm

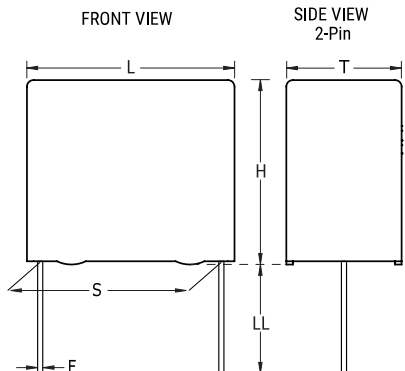

Dimensions	
L	32mm -0.7mm
H	28mm -0.7mm
T	14mm -0.7mm
S	27.5mm +/-0.4mm
LL	6mm -2mm
F	1.2mm NOM

Packaging Specifications	
Packaging:	Bulk, Bag
Packaging Quantity:	96

General Information	
Series:	C4AT
Dielectric:	Metallized Polypropylene
Style:	Radial
Features:	Switching
RoHS:	Yes
Lead:	Wire Leads
AEC-Q200:	No

Specifications	
Capacitance:	5 uF
Capacitance Tolerance:	5%
Voltage AC:	160 VAC
Voltage DC:	250 VDC
Temperature Range:	-40/+85°C
Rated Temperature:	70°C
Dissipation Factor:	0.05%
Max dV/dt:	30 V/us
Resistance:	5.8 mOhms (100kHz)
Ripple Current:	12 Amps (100kHz 70C), 150 Amps (Peak)