

C4AS, Film, Metallized Polypropylene, Power, 0.68 uF, 5%, 500 VAC, 850 VDC, 70°C, Lead Spacing = 27.5mm

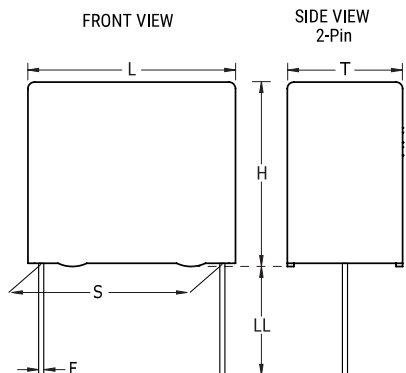

Dimensions	
L	32mm -0.7mm
H	37mm -0.7mm
T	22mm -0.7mm
S	27.5mm +/-0.4mm
LL	6mm -2mm
F	1.2mm NOM

Packaging Specifications	
Packaging:	Bulk, Bag
Packaging Quantity:	64

General Information	
Series:	C4AS
Dielectric:	Metallized Polypropylene
Style:	Radial
RoHS:	Yes
Lead:	Wire Leads
AEC-Q200:	No

Specifications	
Capacitance:	0.68 uF
Capacitance Tolerance:	5%
Voltage AC:	500 VAC
Voltage DC:	850 VDC
Temperature Range:	-40/+85°C
Rated Temperature:	70°C
Dissipation Factor:	0.05%
Max dV/dt:	1232 V/us
Resistance:	4.2 mOhms (100kHz)
Ripple Current:	14 Amps (100kHz 70C), 838 Amps (Peak)

Statements of suitability for certain applications are based on our knowledge of typical operating conditions for such applications, but are not intended to constitute - and we specifically disclaim - any warranty concerning suitability for a specific customer application or use. This Information is intended for use only by customers who have the requisite experience and capability to determine the correct products for their application. Any technical advice inferred from this Information or otherwise provided by us with reference to the use of our products is given gratis, and we assume no obligation or liability for the advice given or results obtained.