

C4AE, Film, Metallized Polypropylene, DC Link, 2.7 uF, 5%, 700 VDC, 70°C, Lead Spacing = 27.5mm

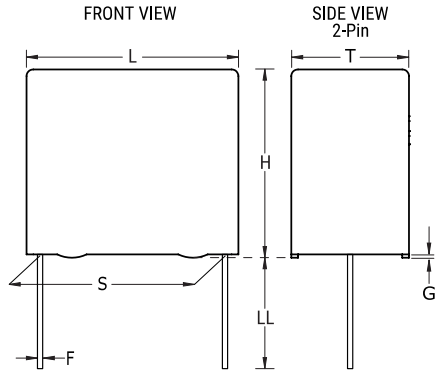

General Information	
Series:	C4AE
Dielectric:	Metallized Polypropylene
Style:	Radial
RoHS:	Yes
Termination:	Tin
Lead:	Wire Leads
AEC-Q200:	No
Miscellaneous:	Thermal Resistance = 44 C/W

Dimensions	
L	31.5mm +0.5mm
H	20mm +0.2mm
T	11mm +0.3mm
S	27.5mm +/-0.4mm
LL	6mm -2mm
F	0.8mm NOM
G	0.5mm NOM

Specifications	
Capacitance:	2.7 uF
Capacitance Tolerance:	5%
Voltage DC:	700 VDC
Temperature Range:	-40/+85°C
Rated Temperature:	70°C
Insulation Resistance:	11.11 MOhms
Max dV/dt:	19 V/us
Resistance:	18.3 mOhms (10kHz 70C)
Ripple Current:	4 Amps (10kHz 70C), 51 Amps (Peak)
Inductance:	25 nH

Packaging Specifications	
Packaging:	Bulk, Box