

C44U, Film, Metallized Polypropylene, DC Link, 150 uF, 10%, 900 VDC

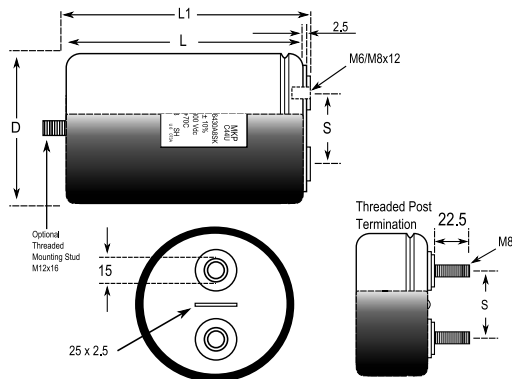

General Information	
Series:	C44U
Dielectric:	Metallized Polypropylene
Style:	Can
Features:	Heavy Duty
RoHS:	Yes
Lead:	Screw Terminals M6
AEC-Q200:	No
Miscellaneous:	Thermal Resistance = 7.2 C/W. Weight = 437 grams.

Dimensions	
D	85mm +/-1mm
L	70mm +/-2mm
L1	76mm +/-2mm
S	31.7mm +/-0.2mm

Specifications	
Capacitance:	150 uF
Capacitance Tolerance:	10%
Voltage DC:	900 VDC
Temperature Range:	-40/+85°C
Rated Temperature:	75°C
Insulation Resistance:	0.2 MOhms
Max dV/dt:	17 V/us
Resistance:	1.4 mOhms (10kHz)
Ripple Current:	65 Amps (10kHz 40C), 2550 Amps (Peak)
Inductance:	40 nH

Packaging Specifications	
Mounting:	Bolt - M12x16
Packaging:	Bulk, Bag
Packaging Quantity:	10

Statements of suitability for certain applications are based on our knowledge of typical operating conditions for such applications, but are not intended to constitute - and we specifically disclaim - any warranty concerning suitability for a specific customer application or use. This Information is intended for use only by customers who have the requisite experience and capability to determine the correct products for their application. Any technical advice inferred from this Information or otherwise provided by us with reference to the use of our products is given gratis, and we assume no obligation or liability for the advice given or results obtained.