

C44E, Film, Metallized Polypropylene, AC Filter, 250 uF, 5%, 250 VAC, 400 VDC

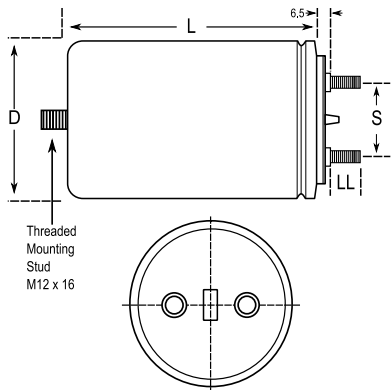

Dimensions	
D	85mm +/-0.5mm
L	185mm +/-2mm
S	35mm +/-0.5mm
LL	25mm NOM

Packaging Specifications	
Mounting:	Bolt - M12x16
Packaging:	Bulk, Bag
Packaging Quantity:	5

General Information	
Series:	C44E
Dielectric:	Metallized Polypropylene
Style:	Can
Features:	Single Phase PFC
RoHS:	Yes
Lead:	Threaded Studs M10
Miscellaneous:	Q = 4.9 kVar. Peak Voltage = 600 VDC

Specifications	
Capacitance:	250 uF
Capacitance Tolerance:	5%
Voltage AC:	250 VAC
Voltage DC:	400 VDC
Temperature Range:	-40/+70°C
Rated Temperature:	70°C
Max dV/dt:	10 V/us
Ripple Current:	60 Amps, 2500 Amps (Peak)