

C44B, Film, Metallized Polypropylene, Power, 0.1 uF, 5%, 500 VAC, 1200 VDC

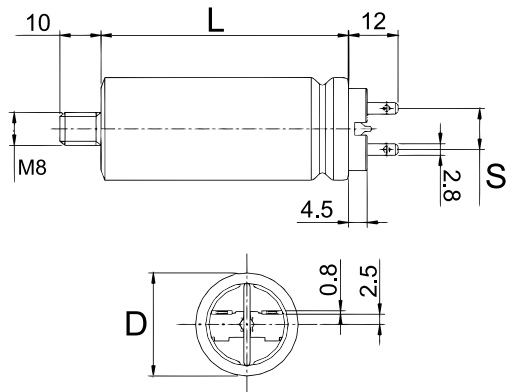

Dimensions	
D	25mm +/-0.5mm
L	60mm +/-2mm
S	10mm +/-0.5mm

Packaging Specifications	
Mounting:	Bolt - M8x10
Packaging:	Bulk, Bag
Packaging Quantity:	210

General Information	
Series:	C44B
Dielectric:	Metallized Polypropylene
Style:	Can
RoHS:	Yes
Lead:	Fast On (1+1)
AEC-Q200:	No
Miscellaneous:	Peak Voltage = 1600 VDC.

Specifications	
Capacitance:	0.1 uF
Capacitance Tolerance:	5%
Voltage AC:	500 VAC
Voltage DC:	1200 VDC
Temperature Range:	-40/+85°C
Rated Temperature:	70°C
Max dV/dt:	500 V/us
Resistance:	25 mOhms (TYP)
Ripple Current:	4 Amps, 50 Amps (Peak)