

GoldMax 300 Comm COG HV, Ceramic, 10 pF, 5%, 3000 VDC, COG, GoldMax, Commercial Standard, Lead Spacing = 5.08mm

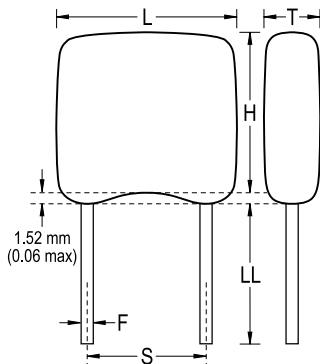

Dimensions	
L	7.62mm MAX
H	9.14mm MAX
T	5.08mm MAX
S	5.08mm +/-0.78mm
LL	7mm MIN
F	0.51mm +0.1/-0.025mm

Packaging Specifications	
Packaging:	Bulk, Bag
Packaging Quantity:	250

General Information	
Series:	GoldMax 300 Comm COG HV
Style:	Radial
Description:	GoldMax, Commercial Standard
RoHS:	Yes
Termination:	Tin
Failure Rate:	N/A
AEC-Q200:	No
Halogen Free:	Yes

Specifications	
Capacitance:	10 pF
Measurement Condition:	1 MHz 1.0Vrms
Capacitance Tolerance:	5%
Voltage DC:	3000 VDC
Dielectric Withstanding Voltage:	3600 VDC
Temperature Range:	-55/+125°C
Temperature Coefficient:	COG
Capacitance Change with Reference to +25°C and 0 VDC Applied (TCC):	30PPM/C, 1MHz 1.0Vrms
Dissipation Factor:	0.1% 1 MHz 1.0Vrms
Aging Rate:	0% Loss/Decade Hour
Insulation Resistance:	100 GOhms

Statements of suitability for certain applications are based on our knowledge of typical operating conditions for such applications, but are not intended to constitute - and we specifically disclaim - any warranty concerning suitability for a specific customer application or use. This Information is intended for use only by customers who have the requisite experience and capability to determine the correct products for their application. Any technical advice inferred from this Information or otherwise provided by us with reference to the use of our products is given gratis, and we assume no obligation or liability for the advice given or results obtained.