

C326C334M5U5TA

aka C326C334M5U5TA

Capacitor, ceramic, 0.33 uF, +/-20% Tol, 50V, Z5U, Lead Spacing=0.1"

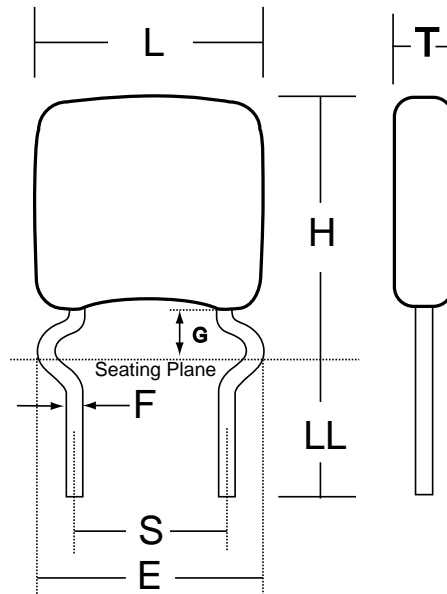

Dimensions (in)

Specifications

ID	Dimension	Tolerance	Manufacturer:	KEMET
L	0.2	max	Capacitance:	0.33 uF
H	0.3	max	Lead Spacing:	0.1"
T	0.125	max	Voltage:	50V
S	0.1	+/-0.03	Temperature Coefficient:	Z5U
LL	0.23	nom	Tolerance:	+/-20%
F	0.02	+0.004/-0.001	Body Type:	Radial Conformal
K	0.02		Lead Type:	Standard Leads
E	0.2	nom	Termination Type:	Tin
G	0.031	ref	Package Kind:	Bulk
			Package Type:	Bag
			Package Quantity:	500

Notes:

-Dimension G represents meniscus-free zone above seating plane

-Lead length shown is for parts supplied in bulk. See packaging specifications for lead lengths when not provided in bulk