

GoldMax 300 Comm COG, Ceramic, 39 pF, 10%, 200 VDC, COG, GoldMax, Commercial Standard, Lead Spacing = 2.54mm

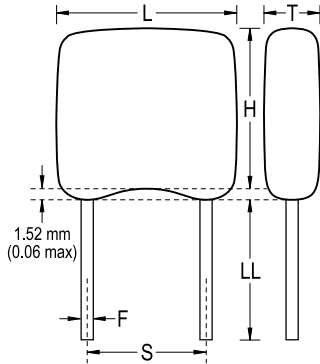

Dimensions

| | |
|-----------|----------------------|
| L | 5.08mm MAX |
| H | 5.84mm MAX |
| T | 3.18mm MAX |
| S | 2.54mm +/-0.78mm |
| LL | 7mm MIN |
| F | 0.51mm +0.1/-0.025mm |

Packaging Specifications

| | |
|----------------------------|-----------|
| Packaging: | Bulk, Bag |
| Packaging Quantity: | 500 |

General Information

| | |
|----------------------|------------------------------|
| Series: | GoldMax 300 Comm COG |
| Style: | Radial |
| Description: | GoldMax, Commercial Standard |
| RoHS: | Yes |
| Termination: | Tin |
| Failure Rate: | N/A |
| AEC-Q200: | No |
| Halogen Free: | Yes |

Specifications

| | |
|--|-----------------------|
| Capacitance: | 39 pF |
| Measurement Condition: | 1 MHz 1.0Vrms |
| Capacitance Tolerance: | 10% |
| Voltage DC: | 200 VDC |
| Dielectric Withstanding Voltage: | 500 VDC |
| Temperature Range: | -55/+125°C |
| Temperature Coefficient: | COG |
| Capacitance Change with Reference to +25°C and 0 VDC Applied (TCC): | 30PPM/C, 1MHz 1.0Vrms |
| Dissipation Factor: | 0.1% 1 MHz 1.0Vrms |
| Aging Rate: | 0% Loss/Decade Hour |
| Insulation Resistance: | 100 GOhms |