

Ceramic, GoldMax, 0.01 uF, 5%, 50 V, X7R, GoldMax, Commercial Standard, Lead Spacing = 2.54mm

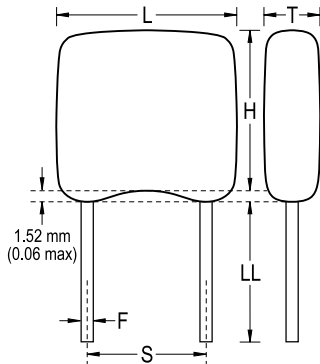

**Dimensions**

<b>L</b>	5.08mm MAX
<b>H</b>	5.84mm MAX
<b>T</b>	3.18mm MAX
<b>S</b>	2.54mm +/-0.78mm
<b>LL</b>	7mm MIN
<b>F</b>	0.51mm +0.1/-0.025mm

**Packaging Specifications**

<b>Packaging:</b>	Bulk, Bag
<b>Packaging Quantity:</b>	500

**General Information**

<b>Style:</b>	Radial
<b>Series:</b>	GoldMax
<b>Description:</b>	GoldMax, Commercial Standard
<b>RoHS:</b>	Yes
<b>Termination:</b>	Tin
<b>Failure Rate:</b>	N/A
<b>Halogen Free:</b>	Yes

**Specifications**

<b>Capacitance:</b>	0.01 uF
<b>Capacitance Tolerance:</b>	5%
<b>Voltage DC:</b>	50 VDC
<b>Dielectric Withstanding Voltage:</b>	125 V
<b>Temperature Range:</b>	-55/+125C
<b>Temperature Coefficient:</b>	X7R
<b>Dissipation Factor:</b>	2.5% 25C
<b>Aging Rate:</b>	3% Loss/Decade Hour
<b>Insulation Resistance:</b>	100 GOhms