

C316C100J2G5TA

aka C316C100J2G5TA

Capacitor, ceramic, 10 pF, +/-5% Tol, 200V, C0G, Lead Spacing=0.1"

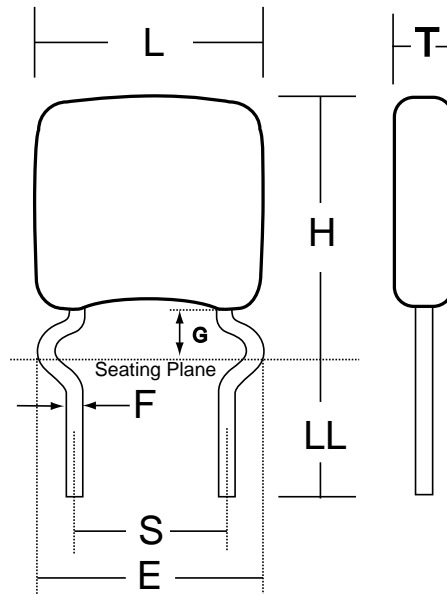

Dimensions (in)

Specifications

ID	Dimension	Tolerance	Manufacturer:	KEMET
L	0.15	max	Capacitance:	10 pF
H	0.23	max	Lead Spacing:	0.1"
T	0.1	max	Voltage:	200V
S	0.1	+/-0.03	Temperature Coefficient:	C0G
LL	0.23	nom	Tolerance:	+/-5%
F	0.02	+0.004/-0.001	Body Type:	Radial Conformal
K	0.02		Lead Type:	Standard Leads
E	0.2	nom	Termination Type:	Tin
			Package Kind:	Bulk
			Package Type:	Bag
			Package Quantity:	500

Notes:

-Lead length shown is for parts supplied in bulk. See packaging specifications for lead lengths when not provided in bulk