

GoldMax 300 Comm COG, Ceramic, 27 pF, 2%, 100 VDC, COG, GoldMax, Commercial Standard, Lead Spacing = 2.54mm

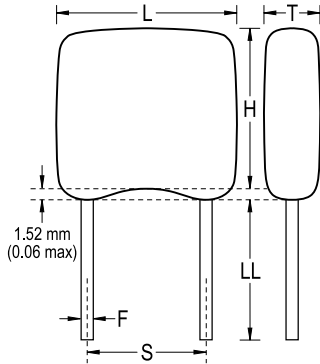

**Dimensions**

<b>L</b>	3.81mm MAX
<b>H</b>	3.14mm MAX
<b>T</b>	2.54mm MAX
<b>S</b>	2.54mm +/-0.78mm
<b>LL</b>	7mm MIN
<b>F</b>	0.51mm +0.1/-0.025mm

**Packaging Specifications**

<b>Packaging:</b>	Bulk, Bag
<b>Packaging Quantity:</b>	500

**General Information**

<b>Series:</b>	GoldMax 300 Comm COG
<b>Style:</b>	Radial
<b>Description:</b>	GoldMax, Commercial Standard
<b>RoHS:</b>	Yes
<b>Termination:</b>	Tin
<b>Failure Rate:</b>	N/A
<b>AEC-Q200:</b>	No
<b>Halogen Free:</b>	Yes

**Specifications**

<b>Capacitance:</b>	27 pF
<b>Measurement Condition:</b>	1 MHz 1.0Vrms
<b>Capacitance Tolerance:</b>	2%
<b>Voltage DC:</b>	100 VDC
<b>Dielectric Withstanding Voltage:</b>	250 VDC
<b>Temperature Range:</b>	-55/+125°C
<b>Temperature Coefficient:</b>	COG
<b>Capacitance Change with Reference to +25°C and 0 VDC Applied (TCC):</b>	30PPM/C, 1MHz 1.0Vrms
<b>Dissipation Factor:</b>	0.1% 1 MHz 1.0Vrms
<b>Aging Rate:</b>	0% Loss/Decade Hour
<b>Insulation Resistance:</b>	100 GOhms

Statements of suitability for certain applications are based on our knowledge of typical operating conditions for such applications, but are not intended to constitute - and we specifically disclaim - any warranty concerning suitability for a specific customer application or use. This Information is intended for use only by customers who have the requisite experience and capability to determine the correct products for their application. Any technical advice inferred from this Information or otherwise provided by us with reference to the use of our products is given gratis, and we assume no obligation or liability for the advice given or results obtained.