

### Double Faston

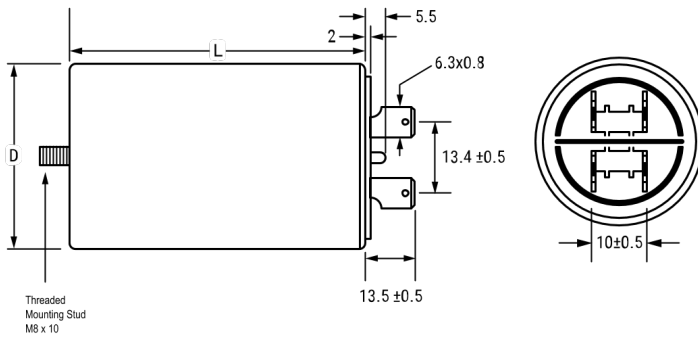

Click [here](#) for the 3D model.

#### Dimensions

D	25mm +1mm
L	58mm +/-2mm

#### Packaging Specifications

Mounting	Through-Hole
Terminal Type	Bolt - M8x11
Packaging	Bulk, Bag

#### General Information

Series	C27
Dielectric	Film/Foil Polypropylene
Style	Can
Description	Plastic Case and Cover, Ultra Sonically Welded Seal
Features	Ultra Sonically Welded Seal, Safety Class P0, UL_94 V0 Disk
RoHS	Yes
Lead	Fast On (2+2)
Qualifications	UL, VDE, UL (Construction Only), UL_94 V0 Disk
AEC-Q200	No
Typical Component Weight	26 g

#### Specifications

Capacitance	3 uF
Capacitance Tolerance	5%
Voltage AC	470 VAC
Temperature Range	-25/+85°C
Rated Temperature	85°C
Max dV/dt	15 V/us