



SPECIFICATION FOR
TDK MULTILAYER CERAMIC CHIP CAPACITORS

NAME OF COMPANY		DWG. NO.
TDK ITEM C0603, C1005, C1608, C2012, C3216, C3225, C4532, C5750 Type / 6.3V to 630V C0G, X5R, X7R, Y5V Characteristics		DATE ISSUED
TDK ENGINEERING SIGNATURE		
DRAWN BY	CHECKED BY	APPROVED BY
DATE	DATE	DATE

Please return this specification to TDK representatives with your signature.

If orders are placed without returned specification, please allow us to judge that specification is accepted by your side.

CUSTOMER RESPONSE

Please check one of three conditions below.

- Approval
- Approval with the following changes
- Reject with the following reasons

NAME OF COMPANY	SIGNATURE	DATE
-----------------	-----------	------

TDK CORPORATION
13-1, Nihonbashi 1-chome, Chuo-ku, Tokyo 103-8272, Japan
Phone: Tokyo(03)3278-5111

1. SCOPE

This specification is applicable to chip type multilayer ceramic capacitors with a priority over the other relevant specifications.

Production places defined in this specification shall be TDK Corporation Japan, TDK Taiwan Corporation, TDK Xiamen Co.,Ltd, TDK(Suzhou)Co.,Ltd, TDK Korea Corporation, TDK(Malaysia)Sdn.Bhd, TDK Components U.S.A. Inc, and TDK Hungary Ltd.

EXPLANATORY NOTE:

This specification warrants the quality of the ceramic chip capacitors. The chips should be evaluated or confirmed a state of mounted on your product.

If the use of the chips goes beyond the bounds of the specification, we can not afford to guarantee.

2. CODE CONSTRUCTION

(Example) C2012 X7R 1E 105 K T
 (1) (2) (3) (4) (5) (6)

(1) Type

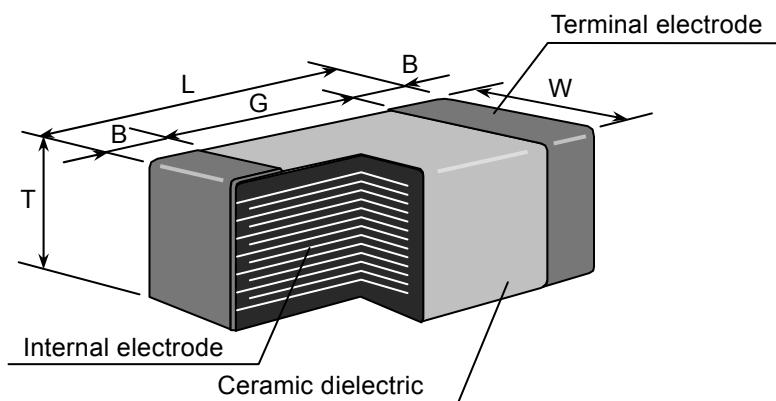

Type	Typical Dimensions (Unit : mm)				
TDK (EIA style)	L	W	T	B	G
C0603 (CC0201)	0.60 ± 0.03	0.30 ± 0.03	0.30 ± 0.03	0.10 - 0.20	0.20 min.
C1005 (CC0402)	1.00 ± 0.05	0.50 ± 0.05	0.50 ± 0.05	0.10 min.	0.30 min.
C1608 (CC0603)	1.60 ± 0.10	0.80 ± 0.10	0.80 ± 0.10	0.20 min.	0.30 min.
C2012 (CC0805)	2.00 ± 0.20	1.25 ± 0.20	1.25 ± 0.20	0.20 min.	0.50 min.
C3216 (CC1206)	3.20 ± 0.20	1.60 ± 0.20	1.60 ± 0.20	0.20 min.	1.00 min.
C3225 (CC1210)	3.20 ± 0.40	2.50 ± 0.30	2.50 ± 0.30	0.20 min.	-
C4532 (CC1812)	4.50 ± 0.40	3.20 ± 0.40	2.50 ± 0.30	0.20 min.	-
C5750 (CC2220)	5.70 ± 0.40	5.00 ± 0.40	2.50 ± 0.30	0.20 min.	-

* As for each item, please refer to the table A in the end of the specification

(2) Temperature Characteristics (Details are shown in table 1 No.6 and No.7 at page 6)

(3) Rated Voltage

Symbol	Rated Voltage
2 J	DC 630 V
2 E	DC 250 V
2 A	DC 100 V
1 H	DC 50 V
1 E	DC 25 V
1 C	DC 16 V
1 A	DC 10 V
0 J	DC 6.3 V

(4) Rated Capacitance

Stated in three digits and in units of pico farads (pF).

The first and Second digits identify the first and second significant figures of the capacitance, the third digit identifies the multiplier.

R is designated for a decimal point.

Example 2R2 → 2.2pF

105 → 1,000,000pF

(5) Capacitance tolerance

Symbol	Tolerance	Capacitance
C	± 0.25 pF	10pF and under
D	± 0.5 pF	
J	± 5 %	Over 10pF
K	± 10 %	
M	± 20 %	
Z	+80, -20%	

(6) Packaging

Symbol	Packaging
B	Bulk
T	Taping

3. RATED CAPACITANCE AND TOLERANCE

3.1 Standard combination of rated capacitance and tolerances

Class	Temperature Characteristics	Capacitance tolerance		Rated capacitance
1	C0G	10pF and under	C ($\pm 0.25\text{pF}$)	0.5, 1, 1.5, 2, 2.2, 3, 3.3, 4, 4.7, 5
			D ($\pm 0.5\text{pF}$)	6, 6.8, 7, 8, 9, 10
		12pF to 10,000pF	J ($\pm 5\%$) K ($\pm 10\%$)	E – 12 series
		Over 10,000pF	K ($\pm 10\%$)	E – 6 series
2	X5R X7R	10uF and under	K ($\pm 10\%$) ^{*1}	E – 6 series
		Over 10uF	M ($\pm 20\%$)	
	Y5V	0.1uF and under	Z (+80, -20%)	E – 1 series
		Over 0.1uF		E – 3 series

*1 The standard capacitance tolerance for C1005X5R0J155, C1005X5R0J225 and C1608X5R0J106 is M ($\pm 20\%$).

3.2 Capacitance Step in E series

E series	Capacitance Step											
E- 1	1.0											
E- 3	1.0			2.2			4.7					
E- 6	1.0	1.5	2.2	3.3	4.7	6.8						
E-12	1.0	1.2	1.5	1.8	2.2	2.7	3.3	3.9	4.7	5.6	6.8	8.2

4. OPERATING TEMPERATURE RANGE

T.C.	Min. operating Temperature	Max. operating Temperature	Reference Temperature
X5R	-55°C	85°C	25°C
Y5V	-30°C	85°C	25°C
X7R C0G	-55°C	125°C	25°C

5. STORING CONDITION AND TERM

5 to 40°C at 20 to 70%RH

6 months Max.

6. P.C. BOARD

When mounting on an aluminum substrate, large case sizes such as C3225, C4532 and C5750 types are more likely to be affected by heat stress from the substrate. Please inquire separate specification for the large case sizes when mounted on the substrate.

7. INDUSTRIAL WASTE DISPOSAL

Dispose this product as industrial waste in accordance with the Industrial Waste Law.

8. PERFORMANCE

table 1

No.	Item	Performance	Test or inspection method																	
1	External Appearance	No defects which may affect performance.	Inspect with magnifying glass (3×), in case of C0603 type, with magnifying glass (10×)																	
2	Insulation Resistance	10,000MΩ or 500MΩ·μF min. (As for the capacitors of rated voltage 16, 10, 6.3V DC and the item below, 10,000 MΩ or 100MΩ·μF min.,) whichever smaller. C1005X5R1E683 C1005X5R1E104 C1608X5R1E334 C1608X5R1E474 C1608X5R1E684 C1608X5R1E105 C2012X5R1E335 C2012X5R1E475	Apply rated voltage for 60s. As for the rated voltage 630V DC, apply 500V.																	
3	Voltage Proof	Withstand test voltage without insulation breakdown or other damage.	<table border="1"> <thead> <tr> <th>Class</th> <th>Rated voltage</th> <th>Apply voltage</th> </tr> </thead> <tbody> <tr> <td rowspan="2">Class1</td> <td>100V and under</td> <td>3 × rated voltage</td> </tr> <tr> <td>Over 100V</td> <td>1.5 × rated voltage</td> </tr> <tr> <td rowspan="2">Class2</td> <td>100V and under</td> <td>2.5 × rated voltage</td> </tr> <tr> <td>Over 100V</td> <td>1.5 × rated voltage</td> </tr> </tbody> </table> <p>Above DC voltage shall be applied for 1 to 5s. Charge / discharge current shall not exceed 50mA.</p>	Class	Rated voltage	Apply voltage	Class1	100V and under	3 × rated voltage	Over 100V	1.5 × rated voltage	Class2	100V and under	2.5 × rated voltage	Over 100V	1.5 × rated voltage				
Class	Rated voltage	Apply voltage																		
Class1	100V and under	3 × rated voltage																		
	Over 100V	1.5 × rated voltage																		
Class2	100V and under	2.5 × rated voltage																		
	Over 100V	1.5 × rated voltage																		
4	Capacitance	Within the specified tolerance.	<table border="1"> <thead> <tr> <th>Class</th> <th>Capacitance</th> <th>Measuring frequency</th> <th>Measuring voltage</th> </tr> </thead> <tbody> <tr> <td rowspan="2">Class1</td> <td>1000pF and under</td> <td>1MHz±10%</td> <td rowspan="2">0.5-5Vrms.</td> </tr> <tr> <td>Over 1000pF</td> <td>1kHz±10%</td> </tr> <tr> <td rowspan="2">Class2</td> <td>10uF and under</td> <td>1kHz±10%</td> <td>1.0±0.2Vrms.</td> </tr> <tr> <td>Over 10uF</td> <td>120Hz±20%</td> <td>0.5±0.2Vrms.</td> </tr> </tbody> </table> <p>The measurement voltage of items below, 0.5±0.2Vrms. C1005X5R0J155 C1005X5R0J225</p>	Class	Capacitance	Measuring frequency	Measuring voltage	Class1	1000pF and under	1MHz±10%	0.5-5Vrms.	Over 1000pF	1kHz±10%	Class2	10uF and under	1kHz±10%	1.0±0.2Vrms.	Over 10uF	120Hz±20%	0.5±0.2Vrms.
Class	Capacitance	Measuring frequency	Measuring voltage																	
Class1	1000pF and under	1MHz±10%	0.5-5Vrms.																	
	Over 1000pF	1kHz±10%																		
Class2	10uF and under	1kHz±10%	1.0±0.2Vrms.																	
	Over 10uF	120Hz±20%	0.5±0.2Vrms.																	
5	Q (Class1) Dissipation Factor (Class2)	Please refer to the table A in the end of the specification	See No.4 in this table for measuring condition.																	

(continued)

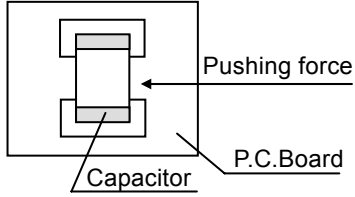
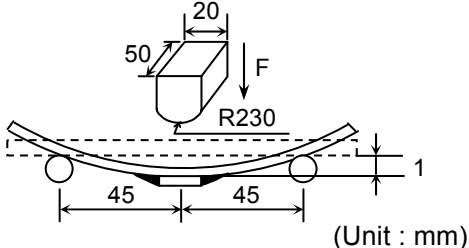
No.	Item	Performance	Test or inspection method																		
6	Temperature Characteristics of Capacitance (Class1)	<table border="1" data-bbox="544 248 916 371"> <tr> <td>T.C.</td> <td>Temperature Coefficient</td> </tr> <tr> <td>C0G</td> <td>0 ± 30 (ppm/°C)</td> </tr> </table> <p>Capacitance drift within ± 0.2% or ± 0.05pF, whichever larger.</p>	T.C.	Temperature Coefficient	C0G	0 ± 30 (ppm/°C)	<p>Temperature coefficient shall be calculated based on values at 25°C and 85°C temperature.</p> <p>Measuring temperature below 20°C shall be -10°C and -25°C.</p>														
T.C.	Temperature Coefficient																				
C0G	0 ± 30 (ppm/°C)																				
7	Temperature Characteristics of Capacitance (Class2)	<p>Capacitance Change (%)</p> <table border="1" data-bbox="544 607 916 786"> <tr> <td colspan="2">No voltage applied</td> </tr> <tr> <td>X5R</td> <td>: ± 15</td> </tr> <tr> <td>X7R</td> <td>: ± 15</td> </tr> <tr> <td>Y5V</td> <td>: + 22/-82</td> </tr> </table>	No voltage applied		X5R	: ± 15	X7R	: ± 15	Y5V	: + 22/-82	<p>Capacitance shall be measured by the steps shown in the following table after thermal equilibrium is obtained for each step.</p> <p>ΔC be calculated ref. STEP3 reading</p> <table border="1" data-bbox="983 701 1442 1048"> <thead> <tr> <th>Step</th> <th>Temperature(°C)</th> </tr> </thead> <tbody> <tr> <td>1</td> <td>Reference temp. ± 2</td> </tr> <tr> <td>2</td> <td>Min. operating temp. ± 3</td> </tr> <tr> <td>3</td> <td>Reference temp. ± 2</td> </tr> <tr> <td>4</td> <td>Max. operating temp. ± 2</td> </tr> </tbody> </table> <p>As for measuring voltage, please refer to the table A in the end of the specification. As for Min. / Max. operating temp. and Reference temp., please refer to “ 4. operating temperature range ” at page 3.</p>	Step	Temperature(°C)	1	Reference temp. ± 2	2	Min. operating temp. ± 3	3	Reference temp. ± 2	4	Max. operating temp. ± 2
No voltage applied																					
X5R	: ± 15																				
X7R	: ± 15																				
Y5V	: + 22/-82																				
Step	Temperature(°C)																				
1	Reference temp. ± 2																				
2	Min. operating temp. ± 3																				
3	Reference temp. ± 2																				
4	Max. operating temp. ± 2																				
8	Robustness of Terminations	No sign of termination coming off, breakage of ceramic, or other abnormal signs.	<p>Reflow solder the capacitors on a P.C.Board shown in Appendix 1a or Appendix 1b and apply a pushing force of 2N (C0603 and C1005) or 5N (C1608, C2012, C3216, C3225, C4532, C5750) with 10±1s.</p> 																		
9	Bending	No mechanical damage.	<p>Reflow solder the capacitors on a P.C.Board shown in Appendix 2a or Appendix 2b and bend it for 1mm.</p>  <p>(Unit : mm)</p>																		

(continued)

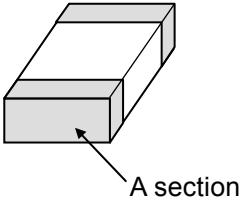
No.	Item	Performance	Test or inspection method																																							
10	Solderability	<p>New solder to cover over 75% of termination. 25% may have pin holes or rough spots but not concentrated in one spot. Ceramic surface of A sections shall not be exposed due to melting or shifting of termination material.</p> 	<p>Completely soak both terminations in solder at 235±5°C for 2±0.5s.</p> <p>Solder : H63A (JIS Z 3282)</p> <p>Flux : Isopropyl alcohol (JIS K 8839) Rosin (JIS K 5902) 25% solid solution.</p>																																							
11	Resistance to solder heat	<table border="1" style="width: 100%; border-collapse: collapse;"> <tr> <td colspan="2" data-bbox="344 757 518 869">External appearance</td> <td colspan="2" data-bbox="518 757 956 869">No cracks are allowed and terminations shall be covered at least 60% with new solder.</td> </tr> <tr> <td colspan="2" data-bbox="344 869 518 1234">Capacitance</td> <td colspan="2" data-bbox="518 869 956 1234"> <table border="1" style="width: 100%; border-collapse: collapse;"> <thead> <tr> <th colspan="2" data-bbox="544 898 719 965">Characteristics</th> <th data-bbox="719 898 956 965">Change from the value before test</th> </tr> </thead> <tbody> <tr> <td data-bbox="544 965 644 1077">Class1</td> <td data-bbox="644 965 719 1077">C0G</td> <td data-bbox="719 965 956 1077">Capacitance drift within ± 2.5% or ± 0.25pF, whichever larger.</td> </tr> <tr> <td data-bbox="544 1077 644 1189" rowspan="3">Class2</td> <td data-bbox="644 1077 719 1122">X5R</td> <td data-bbox="719 1077 956 1122">± 7.5 %</td> </tr> <tr> <td data-bbox="644 1122 719 1167">X7R</td> <td data-bbox="719 1122 956 1167">± 7.5 %</td> </tr> <tr> <td data-bbox="644 1167 719 1189">Y5V</td> <td data-bbox="719 1167 956 1189">± 20 %</td> </tr> </tbody> </table> </td> </tr> <tr> <td data-bbox="344 1234 518 1496">Q (Class1)</td> <td colspan="2" data-bbox="518 1234 956 1496"> <table border="1" style="width: 100%; border-collapse: collapse;"> <thead> <tr> <th data-bbox="544 1272 735 1317">Capacitance</th> <th data-bbox="735 1272 956 1317">Q</th> </tr> </thead> <tbody> <tr> <td data-bbox="544 1317 735 1384">30pF and over</td> <td data-bbox="735 1317 956 1384">1,000 min.</td> </tr> <tr> <td data-bbox="544 1384 735 1451">Under 30pF</td> <td data-bbox="735 1384 956 1451">400+20×C min.</td> </tr> </tbody> </table> <p>C : Rated capacitance (pF)</p> </td> </tr> <tr> <td data-bbox="344 1496 518 1585">D.F. (Class2)</td> <td colspan="2" data-bbox="518 1496 956 1585">Meet the initial spec.</td> </tr> <tr> <td data-bbox="344 1585 518 1697">Insulation Resistance</td> <td colspan="2" data-bbox="518 1585 956 1697">Meet the initial spec.</td> </tr> <tr> <td data-bbox="344 1697 518 1776">Voltage proof</td> <td colspan="2" data-bbox="518 1697 956 1776">No insulation breakdown or other damage.</td> </tr> </table>	External appearance		No cracks are allowed and terminations shall be covered at least 60% with new solder.		Capacitance		<table border="1" style="width: 100%; border-collapse: collapse;"> <thead> <tr> <th colspan="2" data-bbox="544 898 719 965">Characteristics</th> <th data-bbox="719 898 956 965">Change from the value before test</th> </tr> </thead> <tbody> <tr> <td data-bbox="544 965 644 1077">Class1</td> <td data-bbox="644 965 719 1077">C0G</td> <td data-bbox="719 965 956 1077">Capacitance drift within ± 2.5% or ± 0.25pF, whichever larger.</td> </tr> <tr> <td data-bbox="544 1077 644 1189" rowspan="3">Class2</td> <td data-bbox="644 1077 719 1122">X5R</td> <td data-bbox="719 1077 956 1122">± 7.5 %</td> </tr> <tr> <td data-bbox="644 1122 719 1167">X7R</td> <td data-bbox="719 1122 956 1167">± 7.5 %</td> </tr> <tr> <td data-bbox="644 1167 719 1189">Y5V</td> <td data-bbox="719 1167 956 1189">± 20 %</td> </tr> </tbody> </table>		Characteristics		Change from the value before test	Class1	C0G	Capacitance drift within ± 2.5% or ± 0.25pF, whichever larger.	Class2	X5R	± 7.5 %	X7R	± 7.5 %	Y5V	± 20 %	Q (Class1)	<table border="1" style="width: 100%; border-collapse: collapse;"> <thead> <tr> <th data-bbox="544 1272 735 1317">Capacitance</th> <th data-bbox="735 1272 956 1317">Q</th> </tr> </thead> <tbody> <tr> <td data-bbox="544 1317 735 1384">30pF and over</td> <td data-bbox="735 1317 956 1384">1,000 min.</td> </tr> <tr> <td data-bbox="544 1384 735 1451">Under 30pF</td> <td data-bbox="735 1384 956 1451">400+20×C min.</td> </tr> </tbody> </table> <p>C : Rated capacitance (pF)</p>		Capacitance	Q	30pF and over	1,000 min.	Under 30pF	400+20×C min.	D.F. (Class2)	Meet the initial spec.		Insulation Resistance	Meet the initial spec.		Voltage proof	No insulation breakdown or other damage.		<p>Completely soak both terminations in solder at 260±5°C for 5±1s.</p> <p>Preheating condition Temp. : 150±10°C Time : 1 to 2min.</p> <p>Flux : Isopropyl alcohol (JIS K 8839) Rosin (JIS K 5902) 25% solid solution.</p> <p>Solder : H63A (JIS Z 3282)</p> <p>Leave the capacitors in ambient condition for 6 to 24h (Class1) or 24±2h (Class2) before measurement.</p>
External appearance		No cracks are allowed and terminations shall be covered at least 60% with new solder.																																								
Capacitance		<table border="1" style="width: 100%; border-collapse: collapse;"> <thead> <tr> <th colspan="2" data-bbox="544 898 719 965">Characteristics</th> <th data-bbox="719 898 956 965">Change from the value before test</th> </tr> </thead> <tbody> <tr> <td data-bbox="544 965 644 1077">Class1</td> <td data-bbox="644 965 719 1077">C0G</td> <td data-bbox="719 965 956 1077">Capacitance drift within ± 2.5% or ± 0.25pF, whichever larger.</td> </tr> <tr> <td data-bbox="544 1077 644 1189" rowspan="3">Class2</td> <td data-bbox="644 1077 719 1122">X5R</td> <td data-bbox="719 1077 956 1122">± 7.5 %</td> </tr> <tr> <td data-bbox="644 1122 719 1167">X7R</td> <td data-bbox="719 1122 956 1167">± 7.5 %</td> </tr> <tr> <td data-bbox="644 1167 719 1189">Y5V</td> <td data-bbox="719 1167 956 1189">± 20 %</td> </tr> </tbody> </table>		Characteristics		Change from the value before test	Class1	C0G	Capacitance drift within ± 2.5% or ± 0.25pF, whichever larger.	Class2	X5R	± 7.5 %	X7R	± 7.5 %	Y5V	± 20 %																										
Characteristics		Change from the value before test																																								
Class1	C0G	Capacitance drift within ± 2.5% or ± 0.25pF, whichever larger.																																								
Class2	X5R	± 7.5 %																																								
	X7R	± 7.5 %																																								
	Y5V	± 20 %																																								
Q (Class1)	<table border="1" style="width: 100%; border-collapse: collapse;"> <thead> <tr> <th data-bbox="544 1272 735 1317">Capacitance</th> <th data-bbox="735 1272 956 1317">Q</th> </tr> </thead> <tbody> <tr> <td data-bbox="544 1317 735 1384">30pF and over</td> <td data-bbox="735 1317 956 1384">1,000 min.</td> </tr> <tr> <td data-bbox="544 1384 735 1451">Under 30pF</td> <td data-bbox="735 1384 956 1451">400+20×C min.</td> </tr> </tbody> </table> <p>C : Rated capacitance (pF)</p>		Capacitance	Q	30pF and over	1,000 min.	Under 30pF	400+20×C min.																																		
Capacitance	Q																																									
30pF and over	1,000 min.																																									
Under 30pF	400+20×C min.																																									
D.F. (Class2)	Meet the initial spec.																																									
Insulation Resistance	Meet the initial spec.																																									
Voltage proof	No insulation breakdown or other damage.																																									

(continued)

No.	Item		Performance	Test or inspection method															
12	Vibration	External appearance	No mechanical damage.	Reflow solder the capacitors on a P.C.Board shown in Appendix 1a or Appendix 1b before testing. Vibrate the capacitors with amplitude of 1.5mm P-P changing the frequencies from 10Hz to 55Hz and back to 10Hz in about 1min. Repeat this for 2h each in 3 perpendicular directions.															
		Capacitance	<table border="1"> <thead> <tr> <th colspan="2">Characteristics</th> <th>Change from the value before test</th> </tr> </thead> <tbody> <tr> <td rowspan="2">Class1</td> <td>COG</td> <td rowspan="2">Capacitance drift within $\pm 2.5\%$ or $\pm 0.25\text{pF}$, whichever larger.</td> </tr> <tr> <td>X5R</td> <td>$\pm 7.5\%$</td> </tr> <tr> <td rowspan="2">Class2</td> <td>X7R</td> <td>$\pm 7.5\%$</td> </tr> <tr> <td>Y5V</td> <td>$\pm 20\%$</td> </tr> </tbody> </table>		Characteristics		Change from the value before test	Class1	COG	Capacitance drift within $\pm 2.5\%$ or $\pm 0.25\text{pF}$, whichever larger.	X5R	$\pm 7.5\%$	Class2	X7R	$\pm 7.5\%$	Y5V	$\pm 20\%$		
			Characteristics		Change from the value before test														
			Class1		COG	Capacitance drift within $\pm 2.5\%$ or $\pm 0.25\text{pF}$, whichever larger.													
		X5R			$\pm 7.5\%$														
Class2	X7R	$\pm 7.5\%$																	
	Y5V	$\pm 20\%$																	
Q (Class1)	<table border="1"> <thead> <tr> <th>Capacitance</th> <th>Q</th> </tr> </thead> <tbody> <tr> <td>30pF and over</td> <td>1,000 min.</td> </tr> <tr> <td>Under 30pF</td> <td>$400+20\times C$ min.</td> </tr> </tbody> </table> C : Rated capacitance (pF)		Capacitance	Q	30pF and over	1,000 min.	Under 30pF	$400+20\times C$ min.											
	Capacitance	Q																	
30pF and over	1,000 min.																		
Under 30pF	$400+20\times C$ min.																		
D.F. (Class2)	Meet the initial spec.																		
13	Temperature cycle	External appearance	No mechanical damage.	Reflow solder the capacitors on a P.C.Board shown in Appendix 1a or Appendix 1b before testing. Expose the capacitors in the condition step1 through step 4 and repeat 5 times consecutively. Leave the capacitors in ambient condition for 6 to 24h (Class 1) or $24\pm 2\text{h}$ (Class 2) before measurement.															
		Capacitance	<table border="1"> <thead> <tr> <th colspan="2">Characteristics</th> <th>Change from the value before test</th> </tr> </thead> <tbody> <tr> <td rowspan="2">Class1</td> <td>COG</td> <td rowspan="5">Please refer to the table A in the end of the specification.</td> </tr> <tr> <td>X5R</td> </tr> <tr> <td rowspan="3">Class2</td> <td>X7R</td> </tr> <tr> <td>Y5V</td> </tr> </tbody> </table>		Characteristics		Change from the value before test	Class1	COG	Please refer to the table A in the end of the specification.	X5R	Class2	X7R	Y5V					
			Characteristics		Change from the value before test														
			Class1		COG	Please refer to the table A in the end of the specification.													
		X5R																	
		Class2	X7R																
			Y5V																
Q (Class1)	<table border="1"> <thead> <tr> <th>Capacitance</th> <th>Q</th> </tr> </thead> <tbody> <tr> <td>30pF and over</td> <td>1,000 min.</td> </tr> <tr> <td>Under 30pF</td> <td>$400+20\times C$ min.</td> </tr> </tbody> </table> C : Rated capacitance (pF)		Capacitance	Q	30pF and over		1,000 min.	Under 30pF	$400+20\times C$ min.										
	Capacitance	Q																	
30pF and over	1,000 min.																		
Under 30pF	$400+20\times C$ min.																		
D.F. (Class2)	Meet the initial spec.																		
Insulation Resistance	Meet the initial spec.																		
Voltage proof	No insulation breakdown or other damage.																		
				<table border="1"> <thead> <tr> <th>Step</th> <th>Temperature(°C)</th> <th>Time (min.)</th> </tr> </thead> <tbody> <tr> <td>1</td> <td>Min. operating temp. ± 3</td> <td>30 ± 3</td> </tr> <tr> <td>2</td> <td>Reference Temp. ± 2</td> <td>2 - 5</td> </tr> <tr> <td>3</td> <td>Max. operating temp. ± 2</td> <td>30 ± 2</td> </tr> <tr> <td>4</td> <td>Reference Temp. ± 2</td> <td>2 - 5</td> </tr> </tbody> </table>	Step	Temperature(°C)	Time (min.)	1	Min. operating temp. ± 3	30 ± 3	2	Reference Temp. ± 2	2 - 5	3	Max. operating temp. ± 2	30 ± 2	4	Reference Temp. ± 2	2 - 5
Step	Temperature(°C)	Time (min.)																	
1	Min. operating temp. ± 3	30 ± 3																	
2	Reference Temp. ± 2	2 - 5																	
3	Max. operating temp. ± 2	30 ± 2																	
4	Reference Temp. ± 2	2 - 5																	
				As for Min. / Max. operating temp. and Reference temp., please refer to "4. operating temperature range" at page 3.															

(continued)

No.	Item		Performance	Test or inspection method									
14	Moisture Resistance (Steady State)	External appearance	No mechanical damage.	Reflow solder the capacitors on a P.C.Board shown in Appendix 1a or Appendix 1b before testing. Leave at temperature 40±2°C, 90 to 95%RH for 500 +24,0h. Leave the capacitors in ambient condition for 6 to 24h (Class1) or 24±2h (Class2) before measurement.									
		Capacitance	<table border="1" style="width: 100%; border-collapse: collapse;"> <thead> <tr> <th colspan="2" style="text-align: center;">Characteristics</th> <th rowspan="4" style="vertical-align: middle;">Please refer to the table A in the end of the specification.</th> </tr> </thead> <tbody> <tr> <td style="text-align: center;">Class1</td> <td style="text-align: center;">COG</td> </tr> <tr> <td rowspan="2" style="text-align: center;">Class2</td> <td style="text-align: center;">X5R</td> </tr> <tr> <td style="text-align: center;">X7R</td> </tr> <tr> <td colspan="2" style="text-align: center;">Y5V</td> </tr> </tbody> </table>		Characteristics		Please refer to the table A in the end of the specification.	Class1	COG	Class2	X5R	X7R	Y5V
	Characteristics		Please refer to the table A in the end of the specification.										
	Class1	COG											
	Class2	X5R											
X7R													
Y5V													
Q (Class1)	<table border="1" style="width: 100%; border-collapse: collapse;"> <thead> <tr> <th style="text-align: center;">Capacitance</th> <th style="text-align: center;">Q</th> </tr> </thead> <tbody> <tr> <td style="text-align: center;">30pF and over</td> <td style="text-align: center;">350 and over</td> </tr> <tr> <td style="text-align: center;">10pF and over to under 30pF</td> <td style="text-align: center;">275+5/2×C min.</td> </tr> <tr> <td style="text-align: center;">Under 10pF</td> <td style="text-align: center;">200+10×C min.</td> </tr> </tbody> </table> <p style="text-align: center;">C : Rated capacitance (pF)</p>	Capacitance	Q	30pF and over	350 and over	10pF and over to under 30pF	275+5/2×C min.	Under 10pF	200+10×C min.				
Capacitance	Q												
30pF and over	350 and over												
10pF and over to under 30pF	275+5/2×C min.												
Under 10pF	200+10×C min.												
D.F. (Class2)	Characteristics X5R : 200% of initial spec. max. X7R : 200% of initial spec. max. Y5V : 150% of initial spec. max.												
Insulation Resistance	1,000MΩ or 50MΩ·μF min. (As for the capacitors of rated voltage 16, 10, 6.3V DC and item below, 1,000MΩ or 10MΩ·μF min.,) whichever smaller. C1005X5R1E683 C1005X5R1E104 C1608X5R1E334 C1608X5R1E474 C1608X5R1E684 C1608X5R1E105 C2012X5R1E335 C2012X5R1E475												

(continued)

No.	Item		Performance		Test or inspection method									
15	Moisture Resistance	External appearance	No mechanical damage.		Reflow solder the capacitors on a P.C.Board shown in Appendix 1a or Appendix 1b before testing.									
		Capacitance	<table border="1" style="width: 100%; border-collapse: collapse;"> <tr> <td colspan="2" style="text-align: center;">Characteristics</td> <td style="text-align: center;">Change from the value before test</td> </tr> <tr> <td style="text-align: center;">Class1</td> <td style="text-align: center;">C0G</td> <td rowspan="3" style="text-align: center;">Please refer to the table A in the end of the specification.</td> </tr> <tr> <td colspan="2" style="text-align: center;">Class2</td> </tr> <tr> <td style="text-align: center;"></td> <td style="text-align: center;">X5R X7R Y5V</td> </tr> </table>			Characteristics		Change from the value before test	Class1	C0G	Please refer to the table A in the end of the specification.	Class2		
	Characteristics		Change from the value before test											
	Class1	C0G	Please refer to the table A in the end of the specification.											
	Class2													
	X5R X7R Y5V													
Q (Class1)	<table border="1" style="width: 100%; border-collapse: collapse;"> <tr> <td style="text-align: center;">Capacitance</td> <td style="text-align: center;">Q</td> </tr> <tr> <td style="text-align: center;">30pF and over</td> <td style="text-align: center;">200 and over</td> </tr> <tr> <td style="text-align: center;">Under 30pF</td> <td style="text-align: center;">100+10/3×C min.</td> </tr> </table> <p style="margin-left: 20px;">C : Rated capacitance (pF)</p>		Capacitance	Q	30pF and over	200 and over	Under 30pF	100+10/3×C min.	Charge/discharge current shall not exceed 50mA.					
Capacitance	Q													
30pF and over	200 and over													
Under 30pF	100+10/3×C min.													
D.F. (Class2)	Characteristics X5R : 200% of initial spec. max. X7R : 200% of initial spec. max. Y5V : 150% of initial spec. max.		Leave the capacitors in ambient condition for 6 to 24h (Class1) or 24±2h (Class2) before measurement.											
Insulation Resistance	500MΩ or 25MΩ·μF min. (As for the capacitors of rated voltage 16, 10, 6.3V DC and item below, 500MΩ or 5MΩ·μF min.,) whichever smaller. C1005X5R1E683 C1005X5R1E104 C1608X5R1E334 C1608X5R1E474 C1608X5R1E684 C1608X5R1E105 C2012X5R1E335 C2012X5R1E475			Voltage conditioning (only for class 2) Voltage treat the capacitors under testing temperature and voltage for 1 hour.										
Leave the capacitors in ambient condition for 24±2h before measurement. Use this measurement for initial value.														

(continued)

No.	Item	Performance	Test or inspection method										
16	Life	External appearance	No mechanical damage.										
	Capacitance	<table border="1" style="width: 100%; border-collapse: collapse;"> <thead> <tr> <th colspan="2" style="text-align: center;">Characteristics</th> <th style="text-align: center;">Change from the value before test</th> </tr> </thead> <tbody> <tr> <td style="text-align: center;">Class1</td> <td style="text-align: center;">C0G</td> <td rowspan="3" style="text-align: center;">Please refer to the table A in the end of the specification.</td> </tr> <tr> <td style="text-align: center;">Class2</td> <td style="text-align: center;">X5R</td> </tr> <tr> <td></td> <td style="text-align: center;">X7R Y5V</td> </tr> </tbody> </table>	Characteristics		Change from the value before test	Class1	C0G	Please refer to the table A in the end of the specification.	Class2	X5R		X7R Y5V	<p>Reflow solder the capacitors on a P.C.Board shown in Appendix 1a or Appendix 1b before testing.</p> <p>Test condition : maximum operating temperature $\pm 2^{\circ}\text{C}$ for 1,000 +48,0h As for applied voltage, please refer to the table A in the end of the specification.</p>
	Characteristics		Change from the value before test										
	Class1	C0G	Please refer to the table A in the end of the specification.										
	Class2	X5R											
	X7R Y5V												
Q (Class1)	<table border="1" style="width: 100%; border-collapse: collapse;"> <thead> <tr> <th style="text-align: center;">Capacitance</th> <th style="text-align: center;">Q</th> </tr> </thead> <tbody> <tr> <td style="text-align: center;">30pF and over</td> <td style="text-align: center;">350 and over</td> </tr> <tr> <td style="text-align: center;">10pF and over to under 30pF</td> <td style="text-align: center;">$275+5/2 \times C$ min.</td> </tr> <tr> <td style="text-align: center;">Under 10pF</td> <td style="text-align: center;">$200+10 \times C$ min.</td> </tr> </tbody> </table> <p>C : Rated capacitance (pF)</p>	Capacitance	Q	30pF and over	350 and over	10pF and over to under 30pF	$275+5/2 \times C$ min.	Under 10pF	$200+10 \times C$ min.	<p>Charge/discharge current shall not exceed 50mA.</p> <p>Leave the capacitors in ambient condition for 6 to 24h (Class1) or 24\pm2h (Class2) before measurement.</p>			
Capacitance	Q												
30pF and over	350 and over												
10pF and over to under 30pF	$275+5/2 \times C$ min.												
Under 10pF	$200+10 \times C$ min.												
D.F. (Class2)	<p>Characteristics</p> <p>X5R : 200% of initial spec. max. X7R : 200% of initial spec. max. Y5V : 150% of initial spec. max.</p>	<p>Voltage conditioning</p> <p>Voltage treat the capacitors under testing temperature and voltage for 1 hour.</p>											
Insulation Resistance	<p>1,000MΩ or 50MΩ·μF min. (As for the capacitors of rated voltage 16, 10, 6.3V DC and the item below, 1,000 MΩ or 10MΩ·μF min.,) whichever smaller.</p> <p>C1005X5R1E683 C1005X5R1E104 C1608X5R1E334 C1608X5R1E474 C1608X5R1E684 C1608X5R1E105 C2012X5R1E335 C2012X5R1E475</p>	<p>Leave the capacitors in ambient condition for 24\pm2h before measurement.</p> <p>Use this measurement for initial value.</p>											

*As for the initial measurement of capacitors (Class2) on number 7,11,12,13 and 14, leave capacitors at 150 –10,0°C for 1 hour and measure the value after leaving capacitors for 24 \pm 2h in ambient condition.

Appendix - 1a

P.C. Board for reliability test

Applied for C0603, C1005, C1608, C2012, C3216

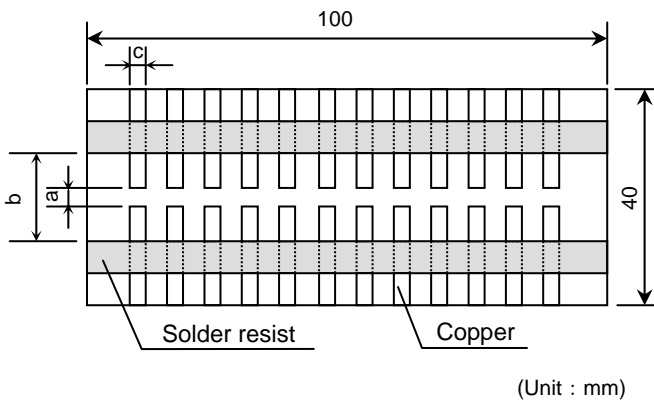

Appendix - 1b

P.C. Board for reliability test

Applied for C3225, C4532, C5750

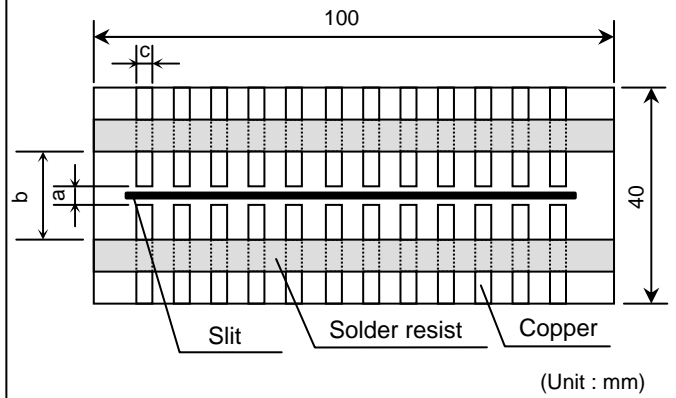

Appendix - 2a

P.C. Board for bending test

Applied for C0603, C1005

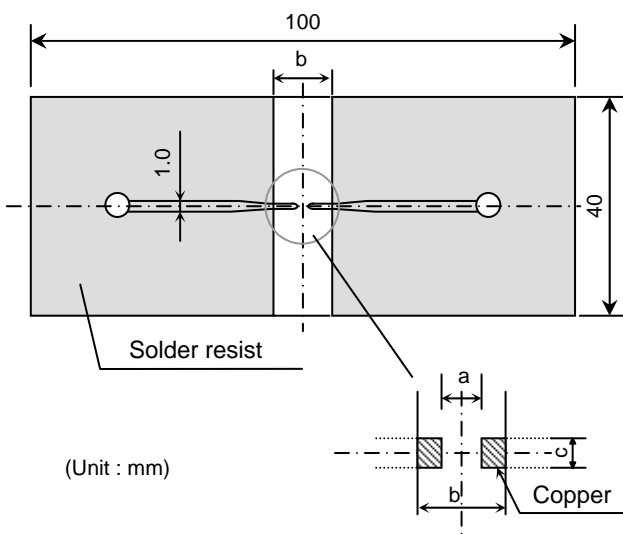

Appendix - 2b

P.C. Board for bending test

Applied for C1608, C2012, C3216, C3225, C4532, C5750

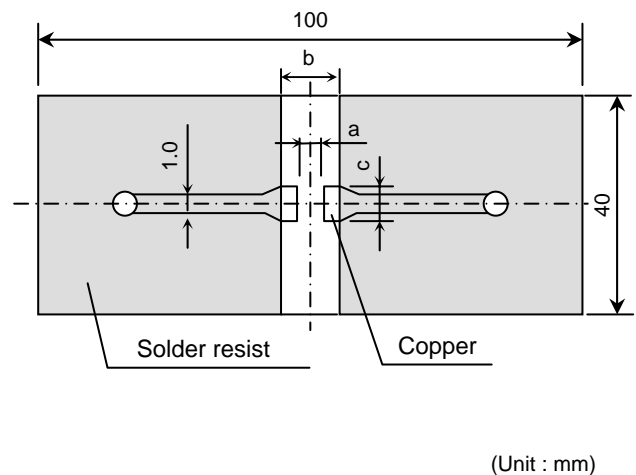

Material : Glass Epoxy (As per JIS C6484 GE4)

P.C. Board thickness : Appendix-2a 0.8mm

Appendix-1a, 1b, 2b 1.6mm

- Copper (thickness 0.035mm)
- Solder resist

TDK (EIA style)	Dimensions (mm)		
	a	b	c
C0603 (CC0201)	0.3	0.8	0.3
C1005 (CC0402)	0.4	1.5	0.5
C1608 (CC0603)	1.0	3.0	1.2
C2012 (CC0805)	1.2	4.0	1.65
C3216 (CC1206)	2.2	5.0	2.0
C3225 (CC1210)	2.2	5.0	2.9
C4532 (CC1812)	3.5	7.0	3.7
C5750 (CC2220)	4.5	8.0	5.6

9. INSIDE STRUCTURE AND MATERIAL

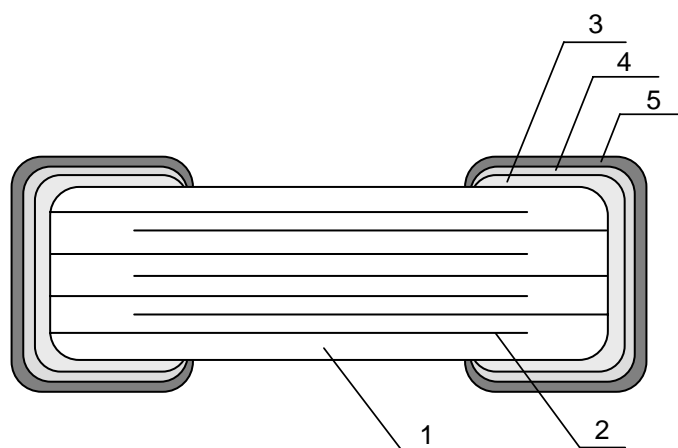

No.	NAME	MATERIAL	
		Class1	Class2
1	Dielectric	CaZrO ₃	BaTiO ₃
2	Electrode	Nickel (Ni)	
3	Termination	Copper (Cu)	
4		Nickel (Ni)	
5		Tin (Sn)	

10. RECOMMENDATION

As for C3225, C4532 and C5750 types, It is recommended to provide a slit (about 1mm wide) in the board under the components to improve washing Flux. And please make sure to dry detergent up completely before.

11. SOLDERING CONDITION

As for C0603, C1005, C3225, C4532 and C5750 types, reflow soldering only.

12. Caution

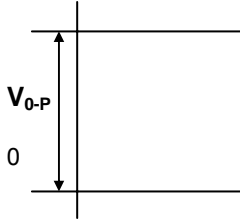
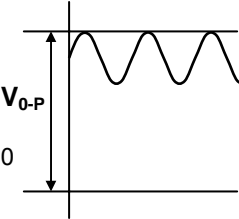
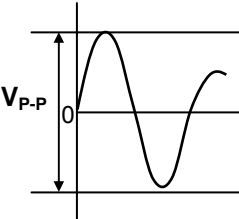
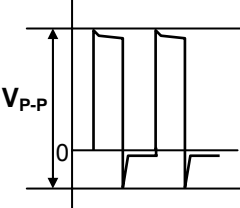
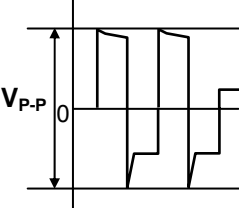
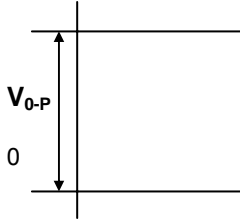
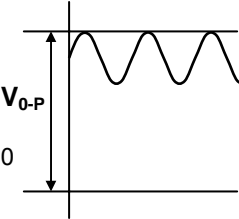
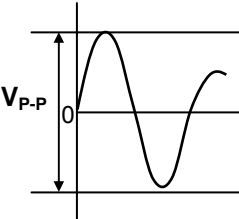
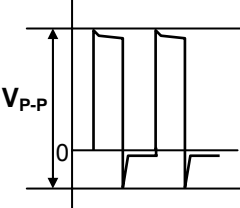
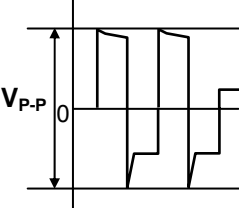
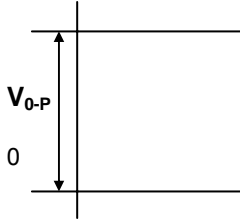
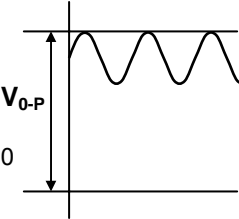
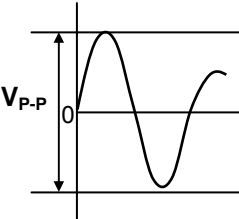
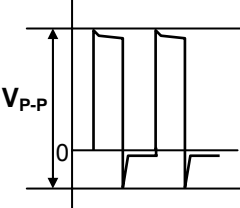
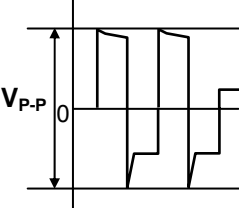
No.	Process	Condition														
1	Operating Condition (Storage, Transportation)	<p>1-1. Storage</p> <ol style="list-style-type: none"> 1) The capacitors must be stored in an ambient temperature of 5 to 40°C with a relative humidity of 20 to 70%RH. The products should be used within 6 months upon receipt. 2) The capacitors must be operated and stored in an environment free of dew condensation and these gases such as Hydrogen Sulphide, Hydrogen Sulphate, Chlorine, Ammonia and sulfur. 3) Avoid storing in sun light and falling of dew. 4) Do not use capacitors under high humidity and high and low atmospheric pressure which may affect capacitors reliability. 5) Capacitors should be tested for the solderability when they are stored for long time. <p>1-2. Handling in transportation</p> <p>In case of the transportation of the capacitors, the performance of the capacitors may be deteriorated depending on the transportation condition. (Refer to JEITA RCR-2335B 9.2 Handling in transportation)</p>														
2	Circuit design ⚠ Caution	<p>2-1. Operating temperature</p> <p>Operating temperature should be followed strictly within this specification, especially be careful with maximum temperature.</p> <ol style="list-style-type: none"> 1) Do not use capacitors above the maximum allowable operating temperature. 2) Surface temperature including self heating should be below maximum operating temperature. (Due to dielectric loss, capacitors will heat itself when AC is applied. Especially at high frequencies around its SRF, the heat might be so extreme that it may damage itself or the product mounted on. Please design the circuit so that the maximum temperature of the capacitors including the self heating to be below the maximum allowable operating temperature. Temperature rise at capacitor surface shall be below 20°C) 3) The electrical characteristics of the capacitors will vary depending on the temperature. The capacitors should be selected and designed in taking the temperature into consideration. <p>2-2. Operating voltage</p> <ol style="list-style-type: none"> 1) Operating voltage across the terminals should be below the rated voltage. When AC and DC are super imposed, V_{0-P} must be below the rated voltage. _____ (1) and (2) AC or pulse with overshooting, V_{P-P} must be below the rated voltage. _____ (3), (4) and (5) When the voltage is started to apply to the circuit or it is stopped applying, the irregular voltage may be generated for a transit period because of resonance or switching. Be sure to use the capacitors within rated voltage containing these Irregular voltage. <table border="1" data-bbox="472 1451 1444 1727"> <thead> <tr> <th data-bbox="472 1451 660 1496">Voltage</th> <th data-bbox="660 1451 922 1496">(1) DC voltage</th> <th data-bbox="922 1451 1184 1496">(2) DC+AC voltage</th> <th data-bbox="1184 1451 1444 1496">(3) AC voltage</th> </tr> </thead> <tbody> <tr> <td data-bbox="472 1496 660 1727">Positional Measurement (Rated voltage)</td> <td data-bbox="660 1496 922 1727">  </td> <td data-bbox="922 1496 1184 1727">  </td> <td data-bbox="1184 1496 1444 1727">  </td> </tr> </tbody> </table> <table border="1" data-bbox="472 1753 1444 2018"> <thead> <tr> <th data-bbox="472 1753 660 1798">Voltage</th> <th data-bbox="660 1753 922 1798">(4) Pulse voltage (A)</th> <th data-bbox="922 1753 1444 1798">(5) Pulse voltage (B)</th> </tr> </thead> <tbody> <tr> <td data-bbox="472 1798 660 2018">Positional Measurement (Rated voltage)</td> <td data-bbox="660 1798 922 2018">  </td> <td data-bbox="922 1798 1444 2018">  </td> </tr> </tbody> </table>	Voltage	(1) DC voltage	(2) DC+AC voltage	(3) AC voltage	Positional Measurement (Rated voltage)				Voltage	(4) Pulse voltage (A)	(5) Pulse voltage (B)	Positional Measurement (Rated voltage)		
Voltage	(1) DC voltage	(2) DC+AC voltage	(3) AC voltage													
Positional Measurement (Rated voltage)																
Voltage	(4) Pulse voltage (A)	(5) Pulse voltage (B)														
Positional Measurement (Rated voltage)																

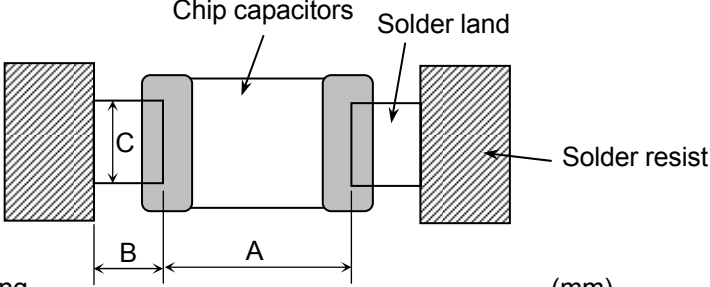
No.	Process	Condition																																																								
2	Circuit design ⚠ Caution	2) Even below the rated voltage, if repetitive high frequency AC or pulse is applied, the reliability of the capacitors may be reduced. 3) The effective capacitance will vary depending on applied DC and AC voltages. The capacitors should be selected and designed in taking the voltages into consideration. 2-3. Frequency When the capacitors (Class 2) are used in AC and/or pulse voltages, the capacitors may vibrate themselves and generate audible sound.																																																								
3	Designing P.C.board	<p>The amount of solder at the terminations has a direct effect on the reliability of the capacitors.</p> <ol style="list-style-type: none"> 1) The greater the amount of solder, the higher the stress on the chip capacitors, and the more likely that it will break. When designing a P.C.board, determine the shape and size of the solder lands to have proper amount of solder on the terminations. 2) Avoid using common solder land for multiple terminations and provide individual solder land for each terminations. 3) Size and recommended land dimensions. <div style="text-align: center;">  </div> <table border="1" style="width: 100%; border-collapse: collapse; margin-top: 10px;"> <caption style="text-align: center;">Flow soldering (mm)</caption> <thead> <tr> <th style="text-align: center;">Type Symbol</th> <th style="text-align: center;">C1608 (CC0603)</th> <th style="text-align: center;">C2012 (CC0805)</th> <th style="text-align: center;">C3216 (CC1206)</th> </tr> </thead> <tbody> <tr> <td style="text-align: center;">A</td> <td style="text-align: center;">0.7 - 1.0</td> <td style="text-align: center;">1.0 - 1.3</td> <td style="text-align: center;">2.1 - 2.5</td> </tr> <tr> <td style="text-align: center;">B</td> <td style="text-align: center;">0.8 - 1.0</td> <td style="text-align: center;">1.0 - 1.2</td> <td style="text-align: center;">1.1 - 1.3</td> </tr> <tr> <td style="text-align: center;">C</td> <td style="text-align: center;">0.6 - 0.8</td> <td style="text-align: center;">0.8 - 1.1</td> <td style="text-align: center;">1.0 - 1.3</td> </tr> </tbody> </table> <table border="1" style="width: 100%; border-collapse: collapse; margin-top: 10px;"> <caption style="text-align: center;">Reflow soldering (mm)</caption> <thead> <tr> <th style="text-align: center;">Type Symbol</th> <th style="text-align: center;">C0603 (CC0201)</th> <th style="text-align: center;">C1005 (CC0402)</th> <th style="text-align: center;">C1608 (CC0603)</th> <th style="text-align: center;">C2012 (CC0805)</th> </tr> </thead> <tbody> <tr> <td style="text-align: center;">A</td> <td style="text-align: center;">0.25 - 0.35</td> <td style="text-align: center;">0.3 - 0.5</td> <td style="text-align: center;">0.6 - 0.8</td> <td style="text-align: center;">0.9 - 1.2</td> </tr> <tr> <td style="text-align: center;">B</td> <td style="text-align: center;">0.2 - 0.3</td> <td style="text-align: center;">0.35 - 0.45</td> <td style="text-align: center;">0.6 - 0.8</td> <td style="text-align: center;">0.7 - 0.9</td> </tr> <tr> <td style="text-align: center;">C</td> <td style="text-align: center;">0.25 - 0.35</td> <td style="text-align: center;">0.4 - 0.6</td> <td style="text-align: center;">0.6 - 0.8</td> <td style="text-align: center;">0.9 - 1.2</td> </tr> </tbody> </table> <table border="1" style="width: 100%; border-collapse: collapse; margin-top: 10px;"> <thead> <tr> <th style="text-align: center;">Type Symbol</th> <th style="text-align: center;">C3216 (CC1206)</th> <th style="text-align: center;">C3225 (CC1210)</th> <th style="text-align: center;">C4532 (CC1812)</th> <th style="text-align: center;">C5750 (CC2220)</th> </tr> </thead> <tbody> <tr> <td style="text-align: center;">A</td> <td style="text-align: center;">2.0 - 2.4</td> <td style="text-align: center;">2.0 - 2.4</td> <td style="text-align: center;">3.1 - 3.7</td> <td style="text-align: center;">4.1 - 4.8</td> </tr> <tr> <td style="text-align: center;">B</td> <td style="text-align: center;">1.0 - 1.2</td> <td style="text-align: center;">1.0 - 1.2</td> <td style="text-align: center;">1.2 - 1.4</td> <td style="text-align: center;">1.2 - 1.4</td> </tr> <tr> <td style="text-align: center;">C</td> <td style="text-align: center;">1.1 - 1.6</td> <td style="text-align: center;">1.9 - 2.5</td> <td style="text-align: center;">2.4 - 3.2</td> <td style="text-align: center;">4.0 - 5.0</td> </tr> </tbody> </table>	Type Symbol	C1608 (CC0603)	C2012 (CC0805)	C3216 (CC1206)	A	0.7 - 1.0	1.0 - 1.3	2.1 - 2.5	B	0.8 - 1.0	1.0 - 1.2	1.1 - 1.3	C	0.6 - 0.8	0.8 - 1.1	1.0 - 1.3	Type Symbol	C0603 (CC0201)	C1005 (CC0402)	C1608 (CC0603)	C2012 (CC0805)	A	0.25 - 0.35	0.3 - 0.5	0.6 - 0.8	0.9 - 1.2	B	0.2 - 0.3	0.35 - 0.45	0.6 - 0.8	0.7 - 0.9	C	0.25 - 0.35	0.4 - 0.6	0.6 - 0.8	0.9 - 1.2	Type Symbol	C3216 (CC1206)	C3225 (CC1210)	C4532 (CC1812)	C5750 (CC2220)	A	2.0 - 2.4	2.0 - 2.4	3.1 - 3.7	4.1 - 4.8	B	1.0 - 1.2	1.0 - 1.2	1.2 - 1.4	1.2 - 1.4	C	1.1 - 1.6	1.9 - 2.5	2.4 - 3.2	4.0 - 5.0
Type Symbol	C1608 (CC0603)	C2012 (CC0805)	C3216 (CC1206)																																																							
A	0.7 - 1.0	1.0 - 1.3	2.1 - 2.5																																																							
B	0.8 - 1.0	1.0 - 1.2	1.1 - 1.3																																																							
C	0.6 - 0.8	0.8 - 1.1	1.0 - 1.3																																																							
Type Symbol	C0603 (CC0201)	C1005 (CC0402)	C1608 (CC0603)	C2012 (CC0805)																																																						
A	0.25 - 0.35	0.3 - 0.5	0.6 - 0.8	0.9 - 1.2																																																						
B	0.2 - 0.3	0.35 - 0.45	0.6 - 0.8	0.7 - 0.9																																																						
C	0.25 - 0.35	0.4 - 0.6	0.6 - 0.8	0.9 - 1.2																																																						
Type Symbol	C3216 (CC1206)	C3225 (CC1210)	C4532 (CC1812)	C5750 (CC2220)																																																						
A	2.0 - 2.4	2.0 - 2.4	3.1 - 3.7	4.1 - 4.8																																																						
B	1.0 - 1.2	1.0 - 1.2	1.2 - 1.4	1.2 - 1.4																																																						
C	1.1 - 1.6	1.9 - 2.5	2.4 - 3.2	4.0 - 5.0																																																						

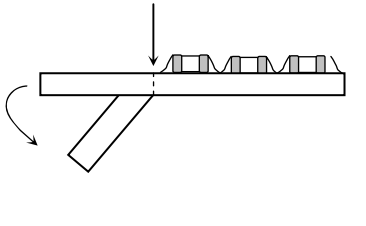
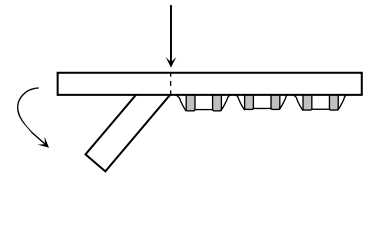
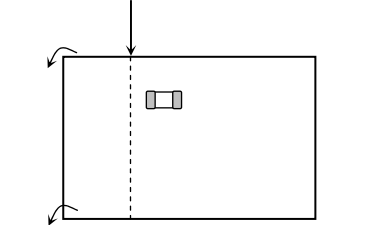
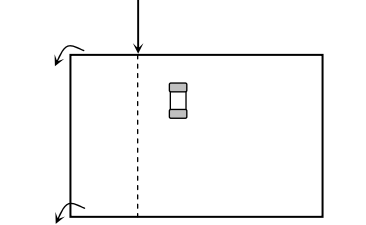
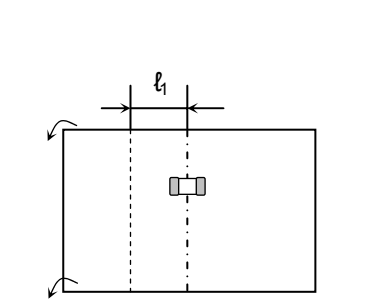
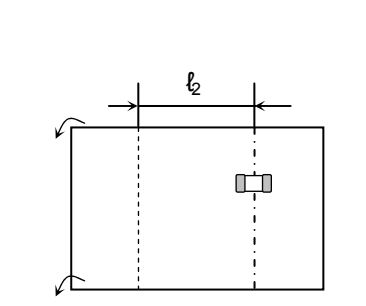
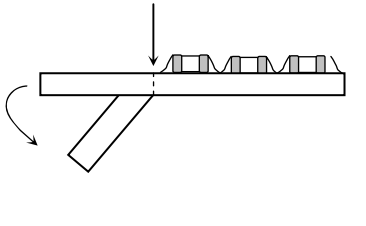
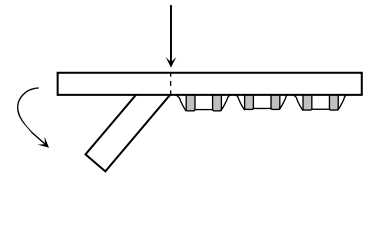
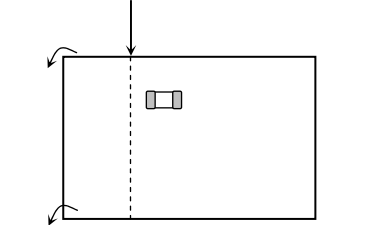
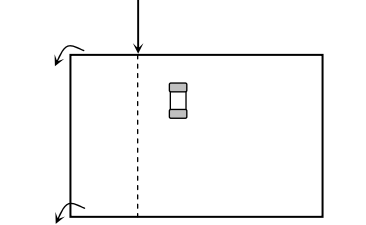
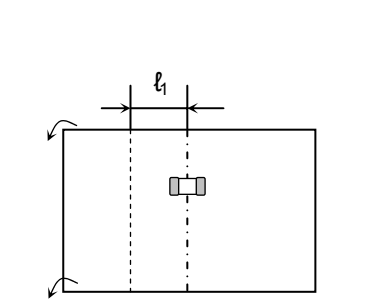
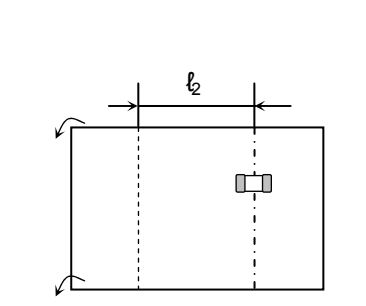
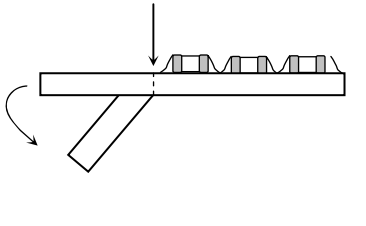
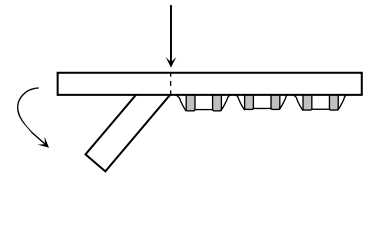
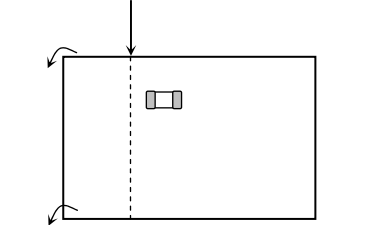
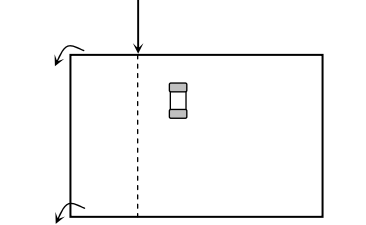
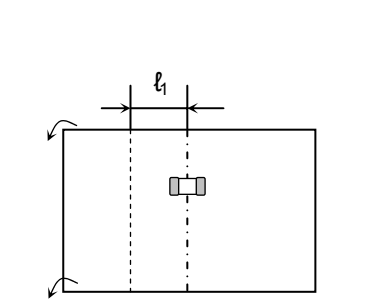
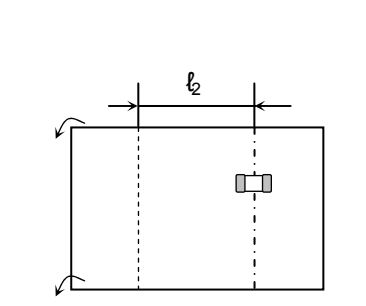
No.	Process	Condition												
3	Designing P.C.board	<p data-bbox="437 147 1098 179">4) Recommended chip capacitors layout is as following.</p> <table border="1" data-bbox="472 219 1426 1639"> <thead> <tr> <th data-bbox="472 219 660 295"></th> <th data-bbox="660 219 1043 295">Disadvantage against bending stress</th> <th data-bbox="1043 219 1426 295">Advantage against bending stress</th> </tr> </thead> <tbody> <tr> <td data-bbox="472 295 660 712">Mounting face</td> <td data-bbox="660 295 1043 712"> <p data-bbox="746 340 954 371">Perforation or slit</p>  <p data-bbox="699 609 954 676">Break P.C.board with mounted side up.</p> </td> <td data-bbox="1043 295 1426 712"> <p data-bbox="1136 340 1343 371">Perforation or slit</p>  <p data-bbox="1098 609 1353 676">Break P.C.board with mounted side down.</p> </td> </tr> <tr> <td data-bbox="472 712 660 1160">Chip arrangement (Direction)</td> <td data-bbox="660 712 1043 1160"> <p data-bbox="746 833 954 864">Perforation or slit</p>  </td> <td data-bbox="1043 712 1426 1160"> <p data-bbox="1136 833 1343 864">Perforation or slit</p>  </td> </tr> <tr> <td data-bbox="472 1160 660 1639">Distance from slit</td> <td data-bbox="660 1160 1043 1639"> <p data-bbox="673 1169 1008 1200">Closer to slit is higher stress</p>  <p data-bbox="922 1541 1008 1572">$(l_1 < l_2)$</p> </td> <td data-bbox="1043 1160 1426 1639"> <p data-bbox="1056 1169 1391 1200">Away from slit is less stress</p>  <p data-bbox="1305 1541 1391 1572">$(l_1 < l_2)$</p> </td> </tr> </tbody> </table>		Disadvantage against bending stress	Advantage against bending stress	Mounting face	<p data-bbox="746 340 954 371">Perforation or slit</p>  <p data-bbox="699 609 954 676">Break P.C.board with mounted side up.</p>	<p data-bbox="1136 340 1343 371">Perforation or slit</p>  <p data-bbox="1098 609 1353 676">Break P.C.board with mounted side down.</p>	Chip arrangement (Direction)	<p data-bbox="746 833 954 864">Perforation or slit</p> 	<p data-bbox="1136 833 1343 864">Perforation or slit</p> 	Distance from slit	<p data-bbox="673 1169 1008 1200">Closer to slit is higher stress</p>  <p data-bbox="922 1541 1008 1572">$(l_1 < l_2)$</p>	<p data-bbox="1056 1169 1391 1200">Away from slit is less stress</p>  <p data-bbox="1305 1541 1391 1572">$(l_1 < l_2)$</p>
	Disadvantage against bending stress	Advantage against bending stress												
Mounting face	<p data-bbox="746 340 954 371">Perforation or slit</p>  <p data-bbox="699 609 954 676">Break P.C.board with mounted side up.</p>	<p data-bbox="1136 340 1343 371">Perforation or slit</p>  <p data-bbox="1098 609 1353 676">Break P.C.board with mounted side down.</p>												
Chip arrangement (Direction)	<p data-bbox="746 833 954 864">Perforation or slit</p> 	<p data-bbox="1136 833 1343 864">Perforation or slit</p> 												
Distance from slit	<p data-bbox="673 1169 1008 1200">Closer to slit is higher stress</p>  <p data-bbox="922 1541 1008 1572">$(l_1 < l_2)$</p>	<p data-bbox="1056 1169 1391 1200">Away from slit is less stress</p>  <p data-bbox="1305 1541 1391 1572">$(l_1 < l_2)$</p>												

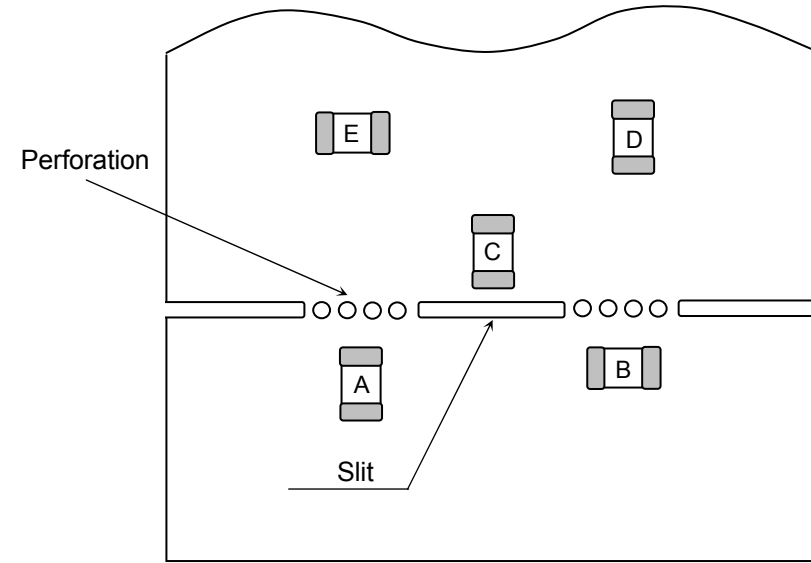
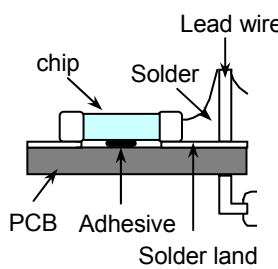
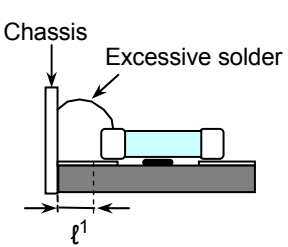
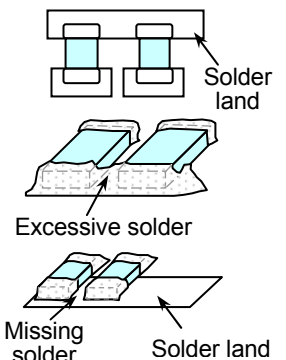
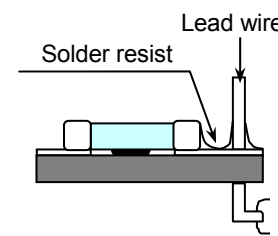
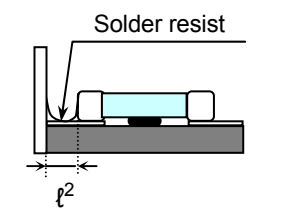
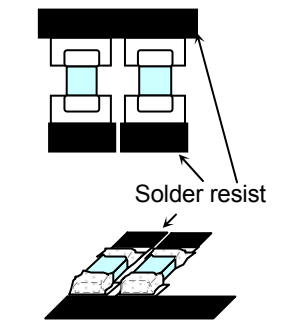
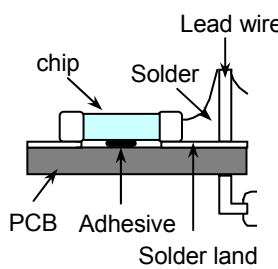
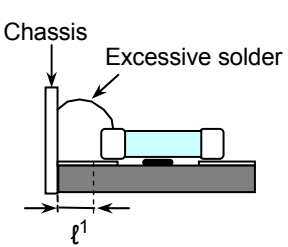
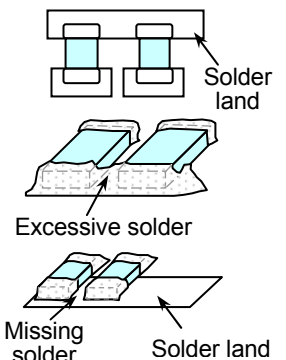
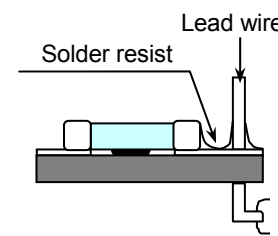
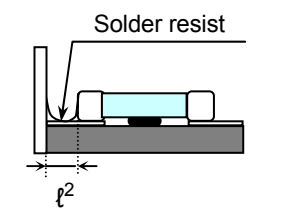
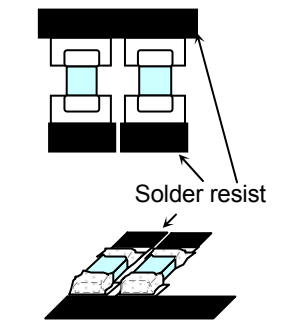
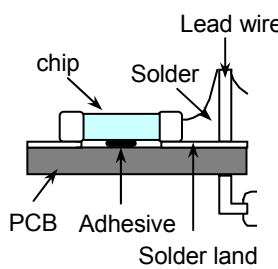
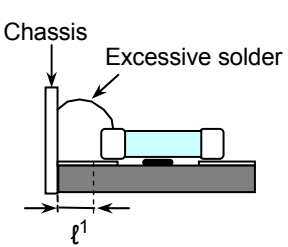
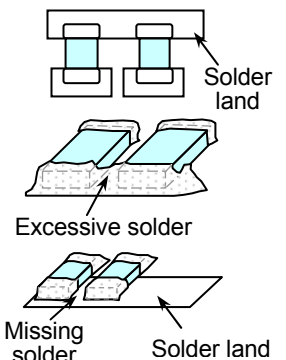
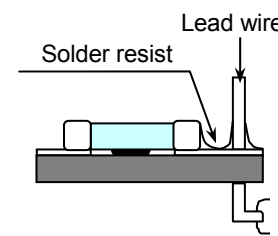
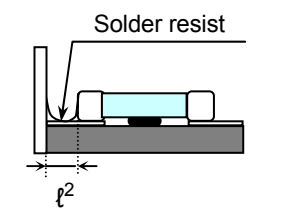
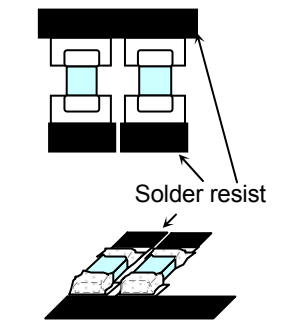
No.	Process	Condition												
3	Designing P.C.board	<p>5) Mechanical stress varies according to location of chip capacitors on the P.C.board.</p>  <p>The stress in capacitors is in the following order. $A > B = C > D > E$</p> <p>6) Layout recommendation</p> <table border="1"> <thead> <tr> <th data-bbox="379 1008 539 1120">Example</th> <th data-bbox="539 1008 842 1120">Use of common solder land</th> <th data-bbox="842 1008 1153 1120">Soldering with chassis</th> <th data-bbox="1153 1008 1481 1120">Use of common solder land with other SMD</th> </tr> </thead> <tbody> <tr> <td data-bbox="379 1120 539 1500">Need to avoid</td> <td data-bbox="539 1120 842 1500">  </td> <td data-bbox="842 1120 1153 1500">  </td> <td data-bbox="1153 1120 1481 1500">  </td> </tr> <tr> <td data-bbox="379 1500 539 1915">Recommendation</td> <td data-bbox="539 1500 842 1915">  </td> <td data-bbox="842 1500 1153 1915">  <p>$l^2 > l^1$</p> </td> <td data-bbox="1153 1500 1481 1915">  </td> </tr> </tbody> </table>	Example	Use of common solder land	Soldering with chassis	Use of common solder land with other SMD	Need to avoid				Recommendation		 <p>$l^2 > l^1$</p>	
Example	Use of common solder land	Soldering with chassis	Use of common solder land with other SMD											
Need to avoid														
Recommendation		 <p>$l^2 > l^1$</p>												

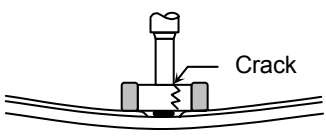
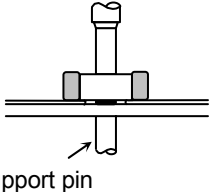
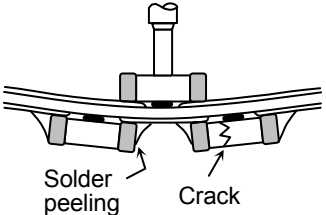
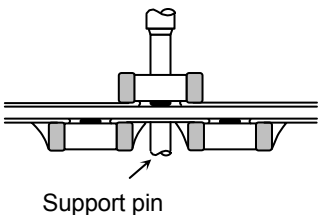
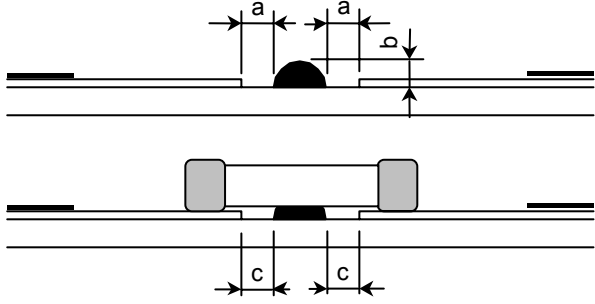
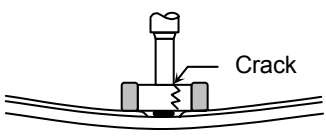
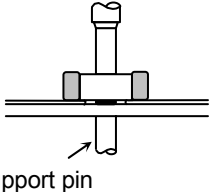
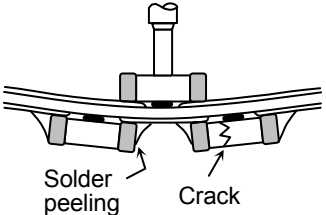
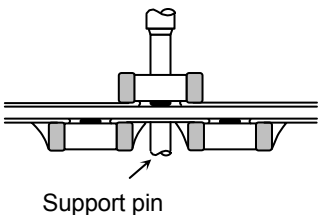
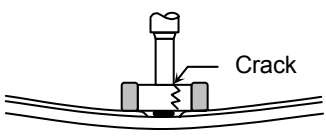
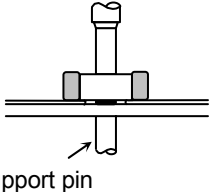
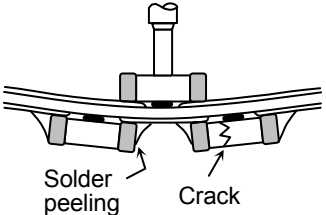
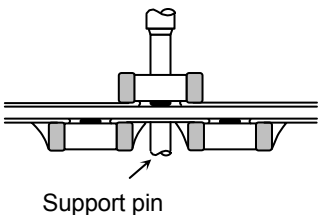
No.	Process	Condition															
4	Mounting	<p>4-1. Stress from mounting head If the mounting head is adjusted too low, it may induce excessive stress in the chip capacitors to result in cracking. Please take following precautions.</p> <ol style="list-style-type: none"> 1) Adjust the bottom dead center of the mounting head to reach on the P.C.board surface and not press it. 2) Adjust the mounting head pressure to be 1 to 3N of static weight. 3) To minimize the impact energy from mounting head, it is important to provide support from the bottom side of the P.C.board. See following examples. <table border="1" data-bbox="480 600 1433 1160"> <thead> <tr> <th></th> <th data-bbox="667 600 1059 645">Not recommended</th> <th data-bbox="1059 600 1433 645">Recommended</th> </tr> </thead> <tbody> <tr> <td data-bbox="480 645 667 898">Single sided mounting</td> <td data-bbox="667 645 1059 898">  </td> <td data-bbox="1059 645 1433 898">  </td> </tr> <tr> <td data-bbox="480 898 667 1160">Double-sides mounting</td> <td data-bbox="667 898 1059 1160">  </td> <td data-bbox="1059 898 1433 1160">  </td> </tr> </tbody> </table> <p>When the centering jaw is worn out, it may give mechanical impact on the capacitors to cause crack. Please control the close up dimension of the centering jaw and provide sufficient preventive maintenance and replacement of it.</p> <p>4-2. Amount of adhesive</p>  <p>Example : C2012 (CC0805), C3216 (CC1206)</p> <table border="1" data-bbox="660 1783 1214 1944"> <tbody> <tr> <td data-bbox="660 1783 810 1839">a</td> <td data-bbox="810 1783 1214 1839">0.2mm min.</td> </tr> <tr> <td data-bbox="660 1839 810 1895">b</td> <td data-bbox="810 1839 1214 1895">70 - 100μm</td> </tr> <tr> <td data-bbox="660 1895 810 1944">c</td> <td data-bbox="810 1895 1214 1944">Do not touch the solder land</td> </tr> </tbody> </table>		Not recommended	Recommended	Single sided mounting			Double-sides mounting			a	0.2mm min.	b	70 - 100 μ m	c	Do not touch the solder land
	Not recommended	Recommended															
Single sided mounting																	
Double-sides mounting																	
a	0.2mm min.																
b	70 - 100 μ m																
c	Do not touch the solder land																

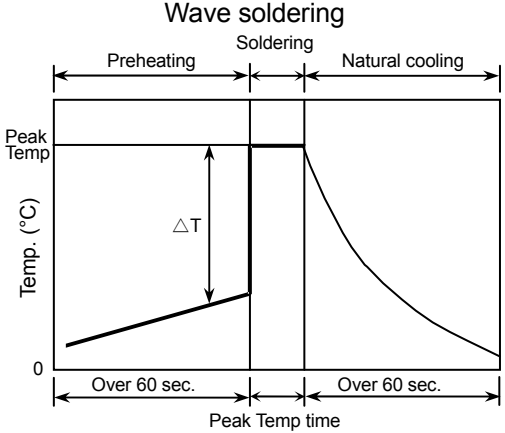
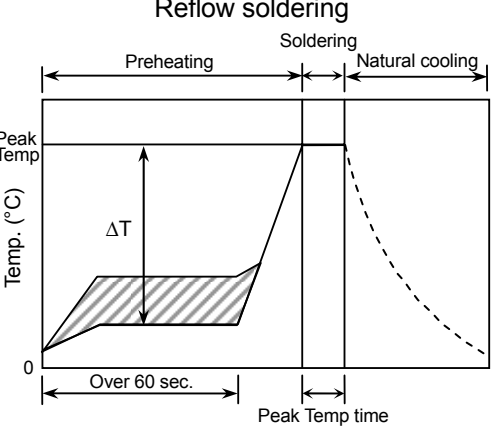
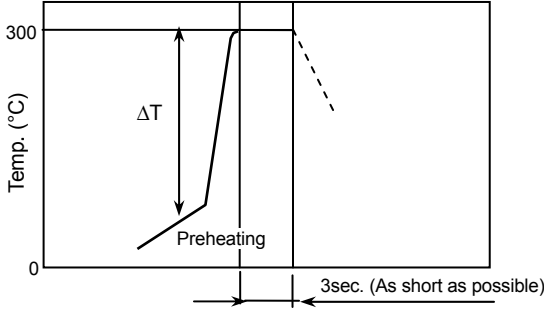
No.	Process	Condition																			
5	Soldering	<p>5-1. Flux selection</p> <p>Although highly-activated flux gives better solderability, substances which increase activity may also degrade the insulation of the chip capacitors. To avoid such degradation, it is recommended following.</p> <ol style="list-style-type: none"> 1) It is recommended to use a mildly activated rosin flux (less than 0.1wt% chlorine). Strong flux is not recommended. 2) Excessive flux must be avoided. Please provide proper amount of flux. 3) When water-soluble flux is used, enough washing is necessary. <p>5-2. Recommended soldering profile by various methods</p> <div style="display: flex; justify-content: space-around;"> <div style="text-align: center;"> <p>Wave soldering</p>  </div> <div style="text-align: center;"> <p>Reflow soldering</p>  </div> </div> <div style="text-align: center; margin-top: 20px;"> <p>Manual soldering (Solder iron)</p>  </div> <div style="margin-top: 20px;"> <p><u>APPLICATION</u></p> <p>As for C1608 (CC0603), C2012 (CC0805) and C3216 (CC1206), applied to wave soldering and reflow soldering.</p> <p>As for C0603 (CC0201), C1005 (CC0402), C3225 (CC1210), C4532 (CC1812), C5750 (CC2220), applied only to reflow soldering.</p> </div> <p>5-3. Recommended soldering peak temp and peak temp duration</p> <table border="1" style="width: 100%; border-collapse: collapse;"> <thead> <tr> <th rowspan="2" style="text-align: center;">Temp./Duration</th> <th colspan="2" style="text-align: center;">Wave soldering</th> <th colspan="2" style="text-align: center;">Reflow soldering</th> </tr> <tr> <th style="text-align: center;">Peak temp(°C)</th> <th style="text-align: center;">Duration(sec.)</th> <th style="text-align: center;">Peak temp(°C)</th> <th style="text-align: center;">Duration(sec.)</th> </tr> </thead> <tbody> <tr> <td style="text-align: center;">Pb-Sn Solder</td> <td style="text-align: center;">250 max.</td> <td style="text-align: center;">3 max.</td> <td style="text-align: center;">230 max.</td> <td style="text-align: center;">20 max.</td> </tr> <tr> <td style="text-align: center;">Lead Free Solder</td> <td style="text-align: center;">260 max.</td> <td style="text-align: center;">5 max.</td> <td style="text-align: center;">260 max.</td> <td style="text-align: center;">10 max.</td> </tr> </tbody> </table> <p>Recommended solder compositions</p> <p>Sn-37Pb (Pb-Sn solder)</p> <p>Sn-3.0Ag-0.5Cu (Lead Free Solder)</p>	Temp./Duration	Wave soldering		Reflow soldering		Peak temp(°C)	Duration(sec.)	Peak temp(°C)	Duration(sec.)	Pb-Sn Solder	250 max.	3 max.	230 max.	20 max.	Lead Free Solder	260 max.	5 max.	260 max.	10 max.
Temp./Duration	Wave soldering			Reflow soldering																	
	Peak temp(°C)	Duration(sec.)	Peak temp(°C)	Duration(sec.)																	
Pb-Sn Solder	250 max.	3 max.	230 max.	20 max.																	
Lead Free Solder	260 max.	5 max.	260 max.	10 max.																	

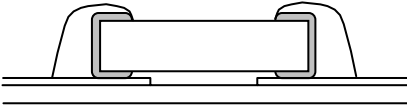
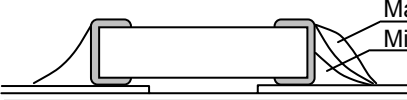
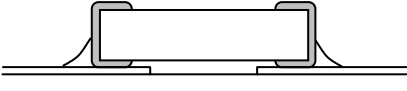
No.	Process	Condition																								
5	Soldering	<p>5-4. Avoiding thermal shock</p> <p>1) Preheating condition</p> <table border="1" data-bbox="552 264 1426 694"> <thead> <tr> <th data-bbox="552 264 778 309">Soldering</th> <th data-bbox="778 264 1219 309">Type</th> <th data-bbox="1219 264 1426 309">Temp. (°C)</th> </tr> </thead> <tbody> <tr> <td data-bbox="552 309 778 369">Wave soldering</td> <td data-bbox="778 309 1219 369">C1608(CC0603), C2012(CC0805), C3216(CC1206)</td> <td data-bbox="1219 309 1426 369">$\Delta T \leq 150$</td> </tr> <tr> <td data-bbox="552 369 778 533" rowspan="2">Reflow soldering</td> <td data-bbox="778 369 1219 465">C0603(CC0201), C1005(CC0402), C1608(CC0603), C2012(CC0805), C3216(CC1206)</td> <td data-bbox="1219 369 1426 465">$\Delta T \leq 150$</td> </tr> <tr> <td data-bbox="778 465 1219 533">C3225(CC1210), C4532(CC1812), C5750(CC2220)</td> <td data-bbox="1219 465 1426 533">$\Delta T \leq 130$</td> </tr> <tr> <td data-bbox="552 533 778 629" rowspan="2">Manual soldering</td> <td data-bbox="778 533 1219 629">C0603(CC0201), C1005(CC0402), C1608(CC0603), C2012(CC0805), C3216(CC1206)</td> <td data-bbox="1219 533 1426 629">$\Delta T \leq 150$</td> </tr> <tr> <td data-bbox="778 629 1219 694">C3225(CC1210), C4532(CC1812), C5750(CC2220)</td> <td data-bbox="1219 629 1426 694">$\Delta T \leq 130$</td> </tr> </tbody> </table> <p>2) Cooling condition</p> <p>Natural cooling using air is recommended. If the chips are dipped into a solvent for cleaning, the temperature difference (ΔT) must be less than 100°C.</p> <p>5-5. Amount of solder</p> <p>Excessive solder will induce higher tensile force in chip capacitors when temperature changes and it may result in chip cracking. In sufficient solder may detach the capacitors from the P.C.board.</p> <div style="display: flex; justify-content: space-between; align-items: flex-start;"> <div style="width: 30%;">Excessive solder</div> <div style="width: 30%; text-align: center;">  </div> <div style="width: 30%;">Higher tensile force in chip capacitors to cause crack</div> </div> <hr/> <div style="display: flex; justify-content: space-between; align-items: center;"> <div style="width: 30%;">Adequate</div> <div style="width: 30%; text-align: center;">  </div> </div> <hr/> <div style="display: flex; justify-content: space-between; align-items: flex-start;"> <div style="width: 30%;">Insufficient solder</div> <div style="width: 30%; text-align: center;">  </div> <div style="width: 30%;">Low robustness may cause contact failure or chip capacitors come off the P.C.board.</div> </div> <p>5-6. Solder repair by solder iron</p> <p>1) Selection of the soldering iron tip</p> <p>Tip temperature of solder iron varies by its type, P.C.board material and solder land size. The higher the tip temperature, the quicker the operation. However, heat shock may cause a crack in the chip capacitors. Please make sure the tip temp. before soldering and keep the peak temp and time in accordance with following recommended condition. (Please preheat the chip capacitors with the condition in 5-4 to avoid the thermal shock.)</p> <p>Recommended solder iron condition (Pb-Sn Solder and Lead Free Solder)</p> <table border="1" data-bbox="552 1895 1390 2002"> <thead> <tr> <th data-bbox="552 1895 762 1951">Temp. (°C)</th> <th data-bbox="762 1895 970 1951">Duration (sec.)</th> <th data-bbox="970 1895 1177 1951">Wattage (W)</th> <th data-bbox="1177 1895 1390 1951">Shape (mm)</th> </tr> </thead> <tbody> <tr> <td data-bbox="552 1951 762 2002">300 max.</td> <td data-bbox="762 1951 970 2002">3 max.</td> <td data-bbox="970 1951 1177 2002">20 max.</td> <td data-bbox="1177 1951 1390 2002">Ø 3.0 max.</td> </tr> </tbody> </table>	Soldering	Type	Temp. (°C)	Wave soldering	C1608(CC0603), C2012(CC0805), C3216(CC1206)	$\Delta T \leq 150$	Reflow soldering	C0603(CC0201), C1005(CC0402), C1608(CC0603), C2012(CC0805), C3216(CC1206)	$\Delta T \leq 150$	C3225(CC1210), C4532(CC1812), C5750(CC2220)	$\Delta T \leq 130$	Manual soldering	C0603(CC0201), C1005(CC0402), C1608(CC0603), C2012(CC0805), C3216(CC1206)	$\Delta T \leq 150$	C3225(CC1210), C4532(CC1812), C5750(CC2220)	$\Delta T \leq 130$	Temp. (°C)	Duration (sec.)	Wattage (W)	Shape (mm)	300 max.	3 max.	20 max.	Ø 3.0 max.
Soldering	Type	Temp. (°C)																								
Wave soldering	C1608(CC0603), C2012(CC0805), C3216(CC1206)	$\Delta T \leq 150$																								
Reflow soldering	C0603(CC0201), C1005(CC0402), C1608(CC0603), C2012(CC0805), C3216(CC1206)	$\Delta T \leq 150$																								
	C3225(CC1210), C4532(CC1812), C5750(CC2220)	$\Delta T \leq 130$																								
Manual soldering	C0603(CC0201), C1005(CC0402), C1608(CC0603), C2012(CC0805), C3216(CC1206)	$\Delta T \leq 150$																								
	C3225(CC1210), C4532(CC1812), C5750(CC2220)	$\Delta T \leq 130$																								
Temp. (°C)	Duration (sec.)	Wattage (W)	Shape (mm)																							
300 max.	3 max.	20 max.	Ø 3.0 max.																							

No.	Process	Condition
5	Soldering	<p>2) Direct contact of the soldering iron with ceramic dielectric of chip capacitors may cause crack. Do not touch the ceramic dielectric and the terminations by solder iron.</p> <p>5-7. Sn-Zn solder Sn-Zn solder affects product reliability. Please contact TDK in advance when utilize Sn-Zn solder.</p> <p>5-8. Countermeasure for tombstone The misalignment between the mounted positions of the capacitors and the land patterns should be minimized. The tombstone phenomenon may occur especially the capacitors are mounted (in longitudinal direction) in the same direction of the reflow soldering. (Refer to JEITA RCR-2335B Annex A (Informative) Recommendations to prevent the tombstone phenomenon)</p>
6	Cleaning	<p>1) If an unsuitable cleaning fluid is used, flux residue or some foreign articles may stick to chip capacitors surface to deteriorate especially the insulation resistance.</p> <p>2) If cleaning condition is not suitable, it may damage the chip capacitors.</p> <p>2)-1. Insufficient washing (1) Terminal electrodes may corrode by Halogen in the flux. (2) Halogen in the flux may adhere on the surface of capacitors, and lower the insulation resistance. (3) Water soluble flux has higher tendency to have above mentioned problems (1) and (2).</p> <p>2)-2. Excessive washing When ultrasonic cleaning is used, excessively high ultrasonic energy output can affect the connection between the ceramic chip capacitor's body and the terminal electrode. To avoid this, following is the recommended condition. Power : 20 W/ ℓ max. Frequency : 40 kHz max. Washing time : 5 minutes max.</p> <p>2)-3. If the cleaning fluid is contaminated, density of Halogen increases, and it may bring the same result as insufficient cleaning.</p>

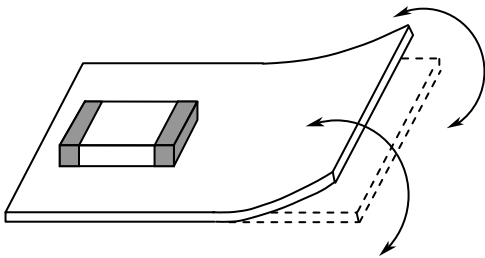
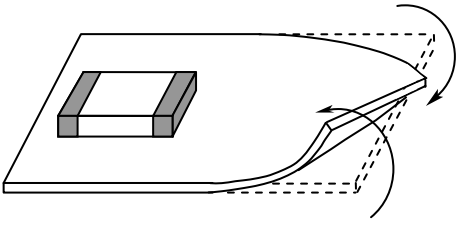
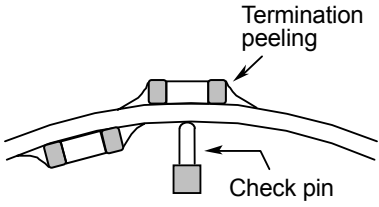
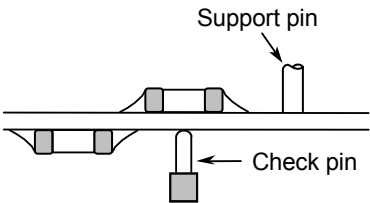
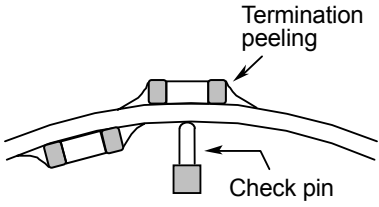
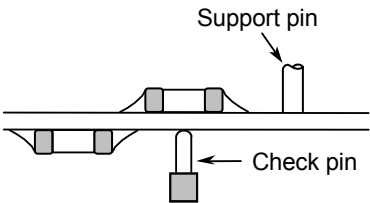
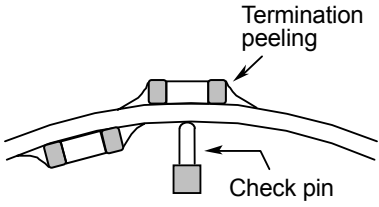
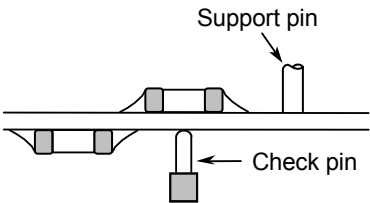
No.	Process	Condition						
7	Coating and molding of the P.C.board	<p>1) When the P.C.board is coated, please verify the quality influence on the product.</p> <p>2) Please verify carefully that there is no harmful decomposing or reaction gas emission during curing which may damage the chip capacitors.</p> <p>3) Please verify the curing temperature.</p>						
8	Handling after chip mounted  Caution	<p>1) Please pay attention not to bend or distort the P.C.board after soldering in handling otherwise the chip capacitors may crack.</p> <div style="display: flex; justify-content: space-around; align-items: center;"> <div style="text-align: center;"> <p>Bend</p>  </div> <div style="text-align: center;"> <p>Twist</p>  </div> </div> <p>2) When functional check of the P.C.board is performed, check pin pressure tends to be adjusted higher for fear of loose contact. But if the pressure is excessive and bend the P.C.board, it may crack the chip capacitors or peel the terminations off. Please adjust the check pins not to bend the P.C.board.</p> <table border="1" style="width: 100%; border-collapse: collapse;"> <thead> <tr> <th data-bbox="491 1189 628 1249">Item</th> <th data-bbox="628 1189 1046 1249">Not recommended</th> <th data-bbox="1046 1189 1445 1249">Recommended</th> </tr> </thead> <tbody> <tr> <td data-bbox="491 1249 628 1547" style="text-align: center; vertical-align: middle;">Board bending</td> <td data-bbox="628 1249 1046 1547" style="text-align: center;">  <p>Termination peeling</p> <p>Check pin</p> </td> <td data-bbox="1046 1249 1445 1547" style="text-align: center;">  <p>Support pin</p> <p>Check pin</p> </td> </tr> </tbody> </table>	Item	Not recommended	Recommended	Board bending	 <p>Termination peeling</p> <p>Check pin</p>	 <p>Support pin</p> <p>Check pin</p>
Item	Not recommended	Recommended						
Board bending	 <p>Termination peeling</p> <p>Check pin</p>	 <p>Support pin</p> <p>Check pin</p>						

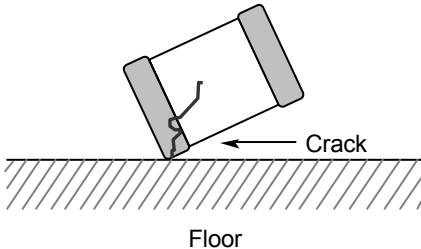
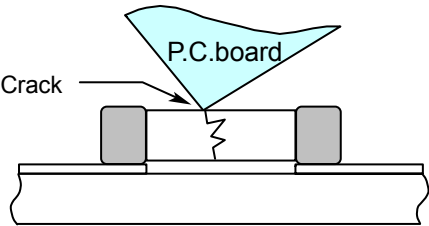
No.	Process	Condition
9	Handling of loose chip capacitors	<p>1) If dropped the chip capacitors may crack. Once dropped do not use it. Especially, the large case sized chip capacitors are tendency to have cracks easily, so please handle with care.</p>  <p>2) Piling the P.C.board after mounting for storage or handling, the corner of the P.C. board may hit the chip capacitors of another board to cause crack.</p> 
10	Capacitance aging	The capacitors (Class 2) have aging in the capacitance. They may not be used in precision time constant circuit. In case of the time constant circuit, the evaluation should be done well.
11	Estimated life and estimated failure rate of capacitors	<p>As per the estimated life and the estimated failure rate depend on the temperature and the voltage. This can be calculated by the equation described in JEITA RCR-2335B Annex F(Informative) Calculation of the estimated lifetime and the estimated failure rate (Temperature acceleration : 3rd powered law, Voltage acceleration : 10°C law)</p> <p>The failure rate can be decreased by reducing the temperature and the voltage but they will not be guaranteed.</p>
12	Others ⚠ Caution	<p>The products listed on this specification sheet are intended for use in general electronic equipment (AV equipment, telecommunications equipment, home appliances, amusement equipment, computer equipment, personal equipment, office equipment, measurement equipment, industrial robots) under a normal operation and use condition.</p> <p>The products are not designed or warranted to meet the requirements of the applications listed below, whose performance and/or quality require a more stringent level of safety or reliability, or whose failure, malfunction or trouble could cause serious damage to society, person or property. Please understand that we are not responsible for any damage or liability caused by use of the products in any of the applications below or for any other use exceeding the range or conditions set forth in this specification sheet.</p> <p>Aerospace/Aviation equipment. Transportation equipment (cars, electric trains, ships, etc.) Medical equipment. Power-generation control equipment. Atomic energy-related equipment. Seabed equipment. Transportation control equipment. Public information-processing equipment. Military equipment. Electric heating apparatus, burning equipment. Disaster prevention/crime prevention equipment. Safety equipment. Other applications that are not considered general-purpose applications.</p> <p>When using this product in general-purpose applications, you are kindly requested to take into consideration securing protection circuit/equipment or providing backup circuits, etc., to ensure higher safety.</p>

13. Packaging label

Packaging shall be done to protect the components from the damage during transportation and storing, and a label which has the following information shall be attached.

- 1) Inspection No.
- 2) TDK P/N
- 3) Customer's P/N
- 4) Quantity

*Composition of Inspection No.

Example M 9 A - 00 - 000
 (a) (b) (c) (d) (e)

- a) Line code
- b) Last digit of the year
- c) Month and A for January and B for February and so on. (Skip I)
- d) Inspection Date of the month.
- e) Serial No. of the day

14. Bulk packaging quantity

Total number of components in a plastic bag for bulk packaging : 1,000pcs.
As for C0603 and C1005 types, not available for bulk packaging.

15. TAPE PACKAGING SPECIFICATION

1. CONSTRUCTION AND DIMENSION OF TAPING

1-1. Dimensions of carrier tape

Dimensions of paper tape shall be according to Appendix 3, 4, 5.

Dimensions of plastic tape shall be according to Appendix 6, 7.

1-2. Bulk part and leader of taping

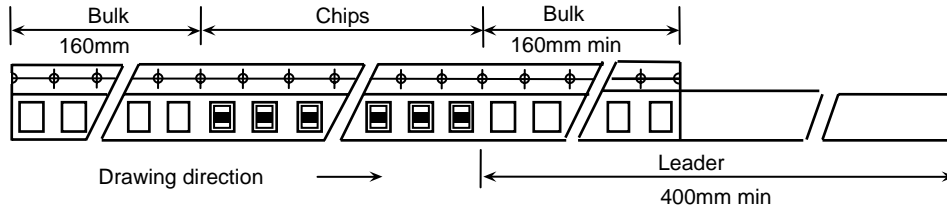

1-3. Dimensions of reel

Dimensions of Ø178 reel shall be according to Appendix 8, 9.

Dimensions of Ø330 reel shall be according to Appendix 10, 11.

1-4. Structure of taping

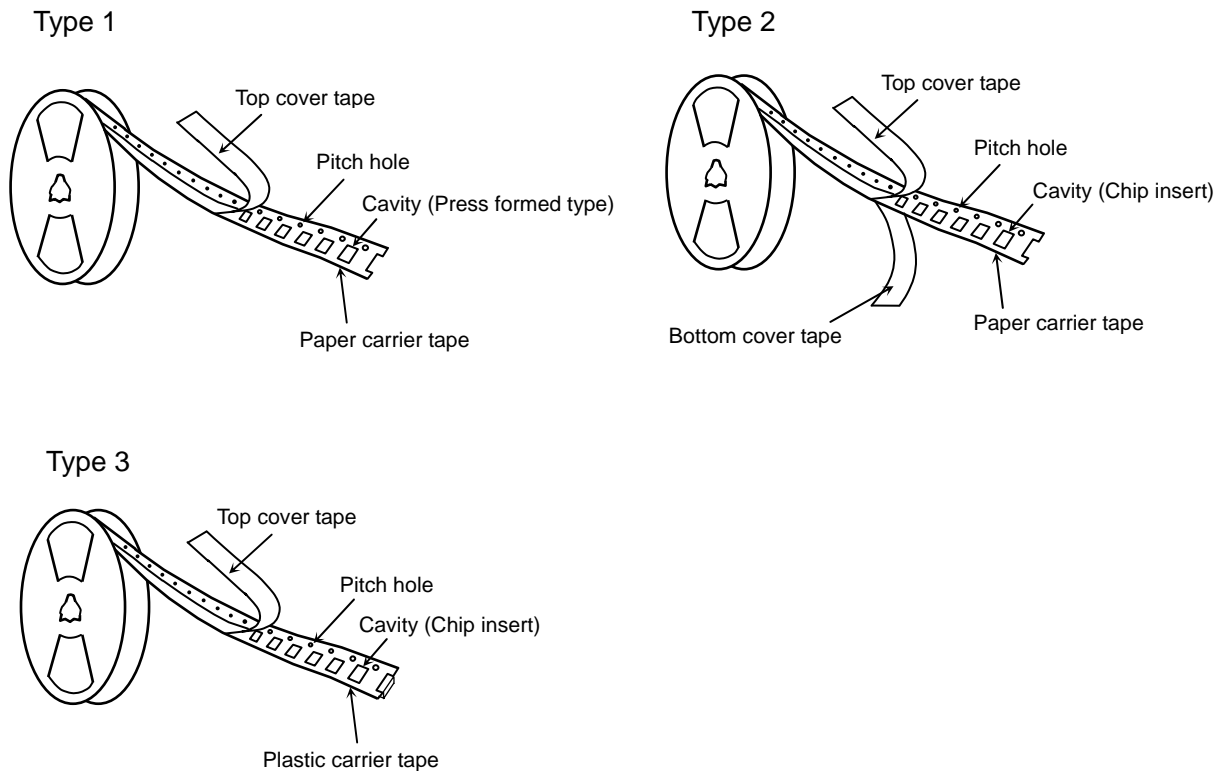

2. CHIP QUANTITY

Please refer to the table A in the end of the specification.

3. PERFORMANCE SPECIFICATIONS

3-1. Fixing peeling strength (top tape)

0.05-0.7N. (See the following figure.)

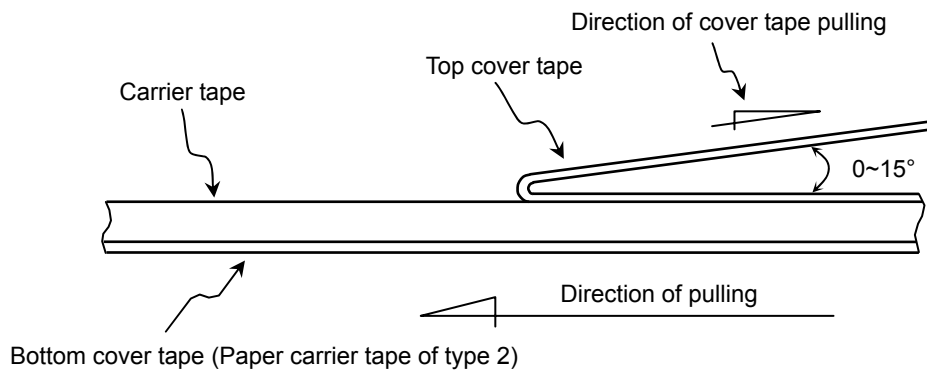

3-2. Carrier tape shall be flexible enough to be wound around a minimum radius of 30mm with components in tape.

3-3. The missing of components shall be less than 0.1%

3-4. Components shall not stick to fixing tape.

3-5. The fixing tapes shall not protrude beyond the edges of the carrier tape
not shall cover the sprocket holes.

Appendix 3

Paper Tape

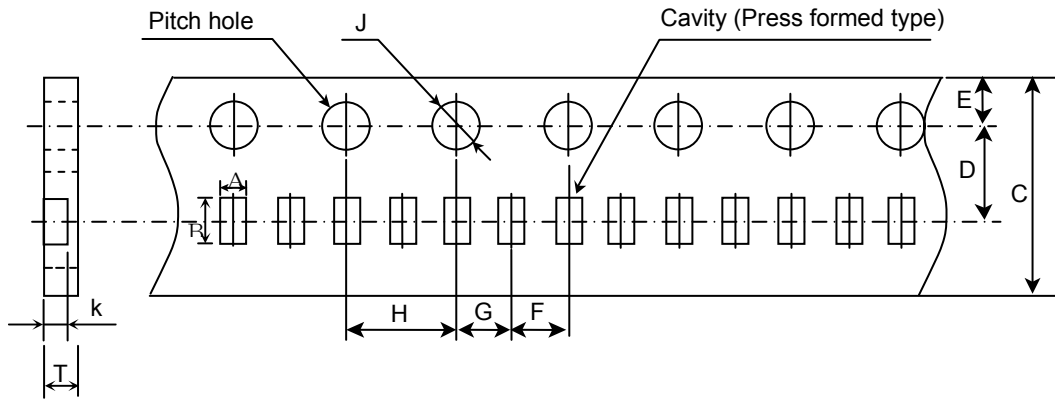

(Unit : mm)

Symbol Type	A	B	C	D	E	F
C0603 (CC0201)	(0.38)	(0.68)	8.00 ± 0.30	3.50 ± 0.05	1.75 ± 0.10	2.00 ± 0.05
C1005 (CC0402)	(0.65)	(1.15)				

Symbol Type	G	H	J	k	T
C0603 (CC0201)	2.00 ± 0.05	4.00 ± 0.05	$\varnothing 1.5 \begin{matrix} +0.10 \\ 0 \end{matrix}$	0.35 ± 0.02	0.40 min.
C1005 (CC0402)				0.55 ± 0.03	0.59 min.

* The values in the parentheses () are for reference.

Appendix 4

Paper Tape

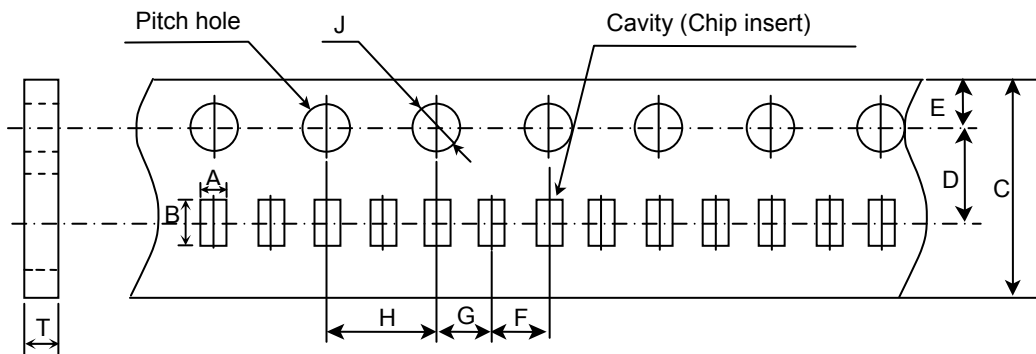

(Unit : mm)

Symbol Type	A	B	C	D	E	F
C1005 (CC0402)	(0.65)	(1.15)	8.00 ± 0.30	3.50 ± 0.05	1.75 ± 0.10	2.00 ± 0.05

Symbol Type	G	H	J	T
C1005 (CC0402)	2.00 ± 0.05	4.00 ± 0.05	$\varnothing 1.5 \begin{matrix} +0.10 \\ 0 \end{matrix}$	0.60 ± 0.05

* The values in the parentheses () are for reference

Appendix 5

Paper Tape

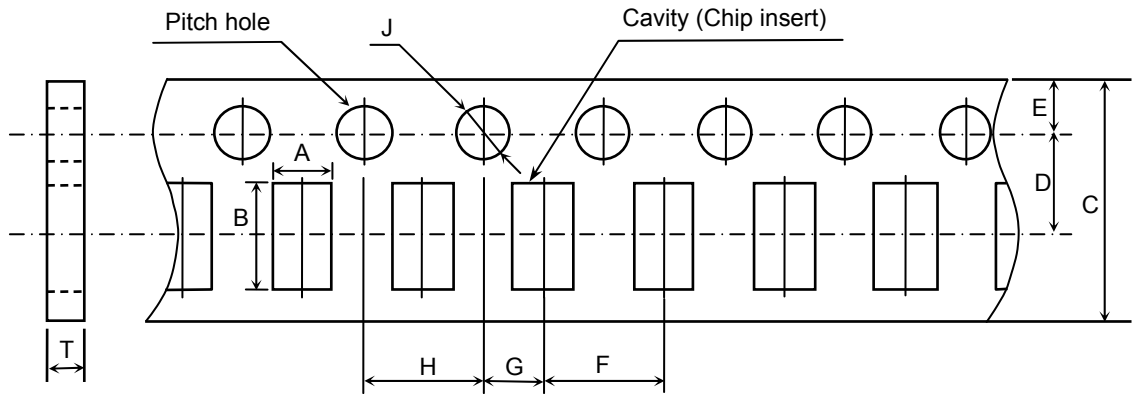

(Unit : mm)

Symbol Type	A	B	C	D	E	F
C1608 (CC0603)	(1.10)	(1.90)	8.00 ± 0.30	3.50 ± 0.05	1.75 ± 0.10	4.00 ± 0.10
C2012 (CC0805)	(1.50)	(2.30)				
C3216 (CC1206)	(1.90)	(3.50)				
Symbol Type	G	H	J	T		
C1608 (CC0603)	2.00 ± 0.05	4.00 ± 0.10	∅ 1.5 ^{+0.10} ₀	1.10 max.		
C2012 (CC0805)						
C3216 (CC1206)						

* The values in the parentheses () are for reference.

Appendix 6

Plastic Tape

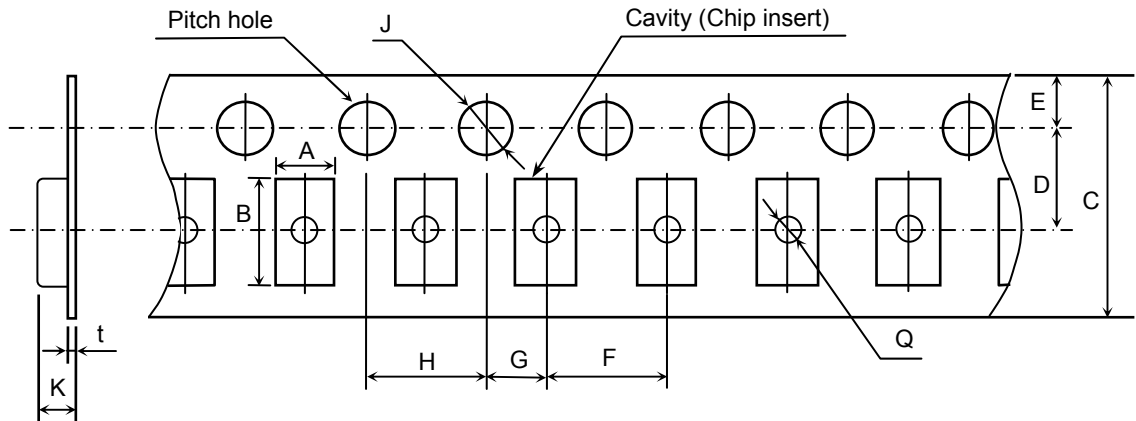

(Unit : mm)

Symbol Type	A	B	C	D	E	F
C2012 (CC0805)	(1.50)	(2.30)	8.00 ± 0.30 [12.0 ± 0.30]	3.50 ± 0.05 [5.50 ± 0.05]	1.75 ± 0.10	4.00 ± 0.10
C3216 (CC1206)	(1.90)	(3.50)				
C3225 (CC1210)	(2.90)	(3.60)				
Symbol Type	G	H	J	K	t	Q
C2012 (CC0805)	2.00 ± 0.05	4.00 ± 0.10	∅ 1.5 ^{+0.10} ₀	2.50 max. [6.50 max.]	0.30 max.	∅ 0.50 min.
C3216 (CC1206)					0.60 max.	
C3225 (CC1210)						

* The values in the parentheses () are for reference.

* As for 2.5mm thickness products, apply values in the brackets [].

Appendix 7

Plastic Tape

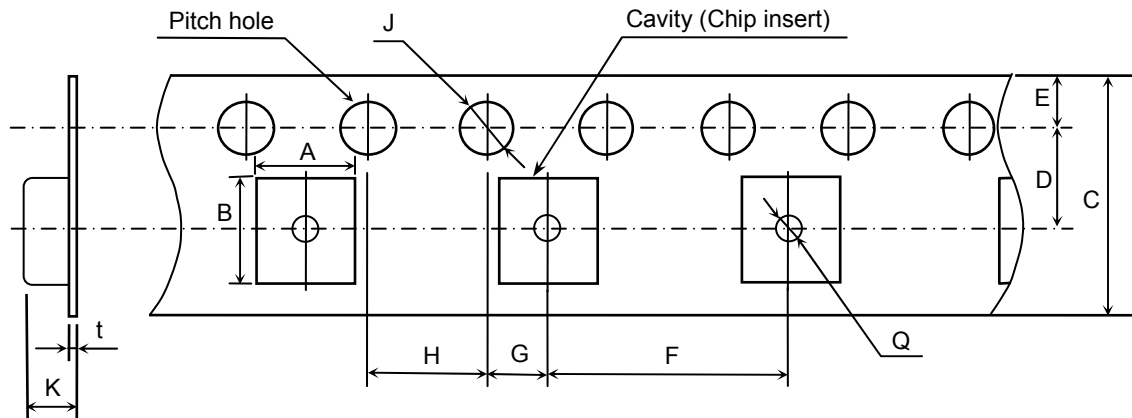

(Unit : mm)

Symbol Type	A	B	C	D	E	F
C4532 (CC1812)	(3.60)	(4.90)	12.0 ± 0.30	5.50 ± 0.05	1.75 ± 0.10	8.00 ± 0.10
C5750 (CC2220)	(5.40)	(6.10)				
Symbol Type	G	H	J	K	t	Q
C4532 (CC1812)	2.00 ± 0.05	4.00 ± 0.10	∅ 1.5 $\begin{matrix} +0.10 \\ 0 \end{matrix}$	6.50 max.	0.60 max.	∅ 1.50 min.
C5750 (CC2220)						

* The values in the parentheses () are for reference.

Appendix 8

C0603, C1005, C1608, C2012, C3216, C3225 (As for C3225 type, any thickness of the item except 2.5mm)

(Material : Polystyrene)

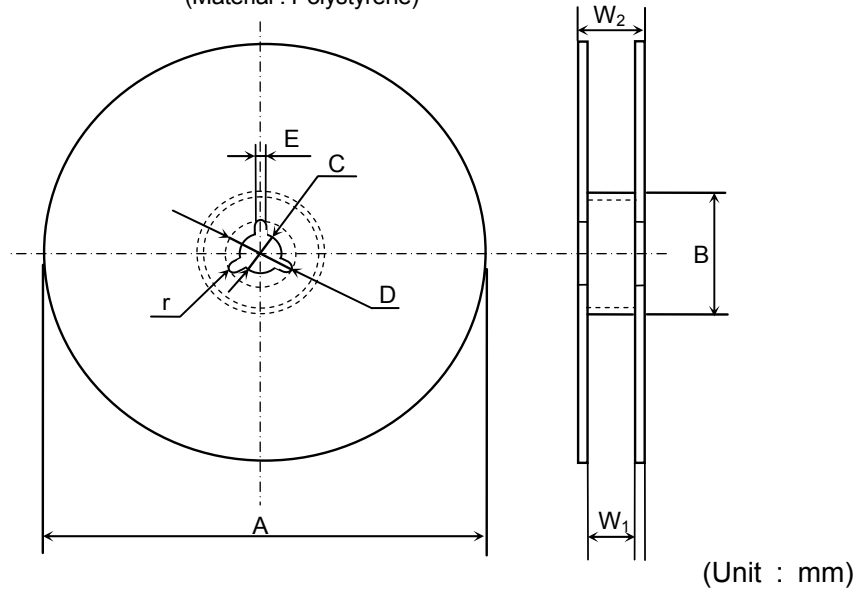

(Unit : mm)

Symbol	A	B	C	D	E	W ₁
Dimension	Ø178 ± 2.0	Ø60 ± 2.0	Ø13 ± 0.5	Ø21 ± 0.8	2.0 ± 0.5	9.0 ± 0.3
Symbol	W ₂	r				
Dimension	13.0 ± 1.4	1.0				

Appendix 9

C3225, C4532, C5750 (As for C3225 type, applied to 2.5mm thickness products)

(Material : Polystyrene)

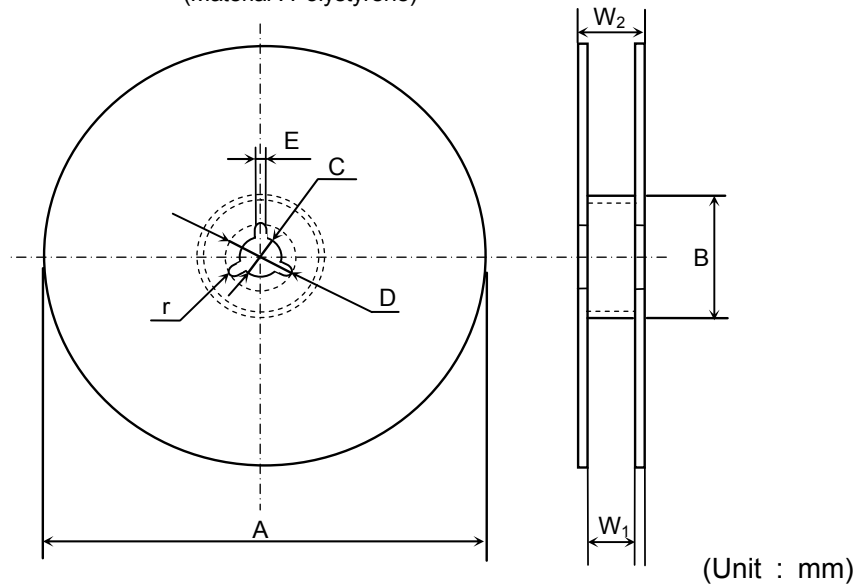

(Unit : mm)

Symbol	A	B	C	D	E	W ₁
Dimension	Ø178 ± 2.0	Ø60 ± 2.0	Ø13 ± 0.5	Ø21 ± 0.8	2.0 ± 0.5	13.0 ± 0.3
Symbol	W ₂	r				
Dimension	17.0 ± 1.4	1.0				

Appendix 10

C1005, C1608, C2012, C3216, C3225 (As for C3225 type, any thickness of the item except 2.5mm)

(Material : Polystyrene)

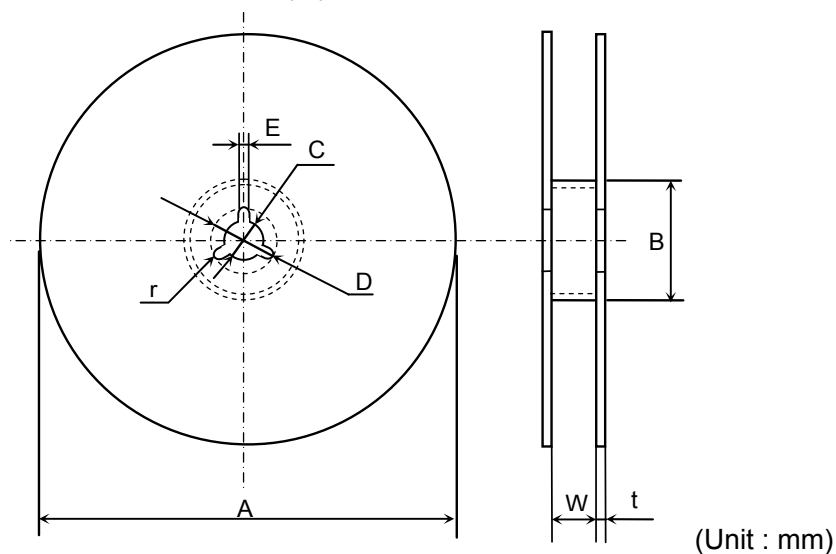

Symbol	A	B	C	D	E	W
Dimension	Ø382 max. (Nominal Ø330)	Ø50 min.	Ø13 ± 0.5	Ø21 ± 0.8	2.0 ± 0.5	10.0 ± 1.5

Symbol	t	r
Dimension	2.0 ± 0.5	1.0

Appendix 11

C3225, C4532, C5750 (As for C3225 type, applied to 2.5mm thickness products)

(Material : Polystyrene)

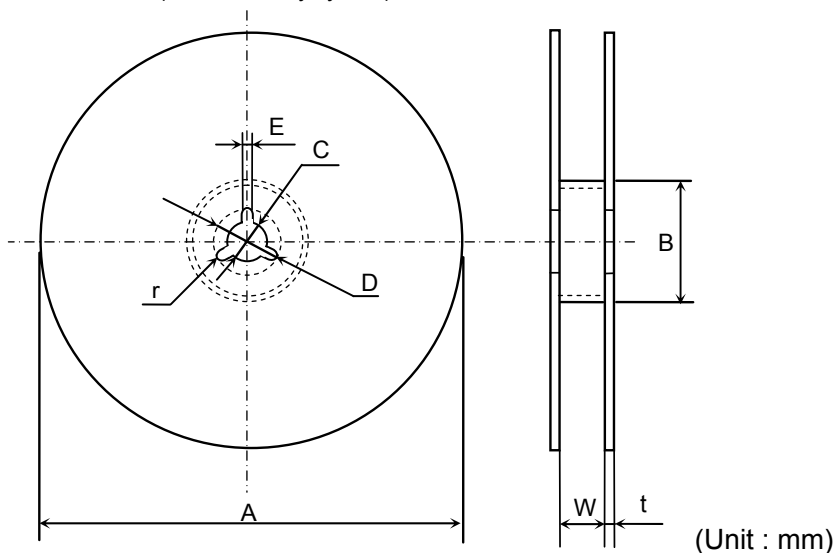

Symbol	A	B	C	D	E	W
Dimension	Ø382 max. (Nominal Ø330)	Ø50 min.	Ø13 ± 0.5	Ø21 ± 0.8	2.0 ± 0.5	14.0 ± 1.5

Symbol	t	r
Dimension	2.0 ± 0.5	1.0

16. Table A (TDK products line up)

No	Your Part No.	TDK product	Dimensions			Q (min.)	tanδ (max.)	Temp. Characteristics of Cap.		Temp cycle	Moisture Resistance (Steady state)		Moisture Resistance		Life		Tape packaging materials	Qty. per 1 reel	
			L (mm)	W (mm)	T (mm)			Measuring frequency	Measuring voltage		ΔC/C	ΔC/C	ΔC/C	ΔC/C	Test voltage	φ178mm		φ330mm	
1		C0603C0G1E0R5C	0.60±0.03	0.30±0.03	0.30±0.03	410		1MHz	0.5-5Vrms	±0.25pF	±0.5pF	±0.75pF	±0.3pF	2.0 x R.V.	Paper	15,000	50,000		
2		C0603C0G1E010C	0.60±0.03	0.30±0.03	0.30±0.03	420		1MHz	0.5-5Vrms	±0.25pF	±0.5pF	±0.75pF	±0.3pF	2.0 x R.V.	Paper	15,000	50,000		
3		C0603C0G1E1R5C	0.60±0.03	0.30±0.03	0.30±0.03	430		1MHz	0.5-5Vrms	±0.25pF	±0.5pF	±0.75pF	±0.3pF	2.0 x R.V.	Paper	15,000	50,000		
4		C0603C0G1E020C	0.60±0.03	0.30±0.03	0.30±0.03	440		1MHz	0.5-5Vrms	±0.25pF	±0.5pF	±0.75pF	±0.3pF	2.0 x R.V.	Paper	15,000	50,000		
5		C0603C0G1E2R2C	0.60±0.03	0.30±0.03	0.30±0.03	444		1MHz	0.5-5Vrms	±0.25pF	±0.5pF	±0.75pF	±0.3pF	2.0 x R.V.	Paper	15,000	50,000		
6		C0603C0G1E030C	0.60±0.03	0.30±0.03	0.30±0.03	460		1MHz	0.5-5Vrms	±0.25pF	±0.5pF	±0.75pF	±0.3pF	2.0 x R.V.	Paper	15,000	50,000		
7		C0603C0G1E3R3C	0.60±0.03	0.30±0.03	0.30±0.03	466		1MHz	0.5-5Vrms	±0.25pF	±0.5pF	±0.75pF	±0.3pF	2.0 x R.V.	Paper	15,000	50,000		
8		C0603C0G1E040C	0.60±0.03	0.30±0.03	0.30±0.03	480		1MHz	0.5-5Vrms	±0.25pF	±0.5pF	±0.75pF	±0.3pF	2.0 x R.V.	Paper	15,000	50,000		
9		C0603C0G1E4R7C	0.60±0.03	0.30±0.03	0.30±0.03	494		1MHz	0.5-5Vrms	±0.25pF	±0.5pF	±0.75pF	±0.3pF	2.0 x R.V.	Paper	15,000	50,000		
10		C0603C0G1E050C	0.60±0.03	0.30±0.03	0.30±0.03	500		1MHz	0.5-5Vrms	±0.25pF	±0.5pF	±0.75pF	±0.3pF	2.0 x R.V.	Paper	15,000	50,000		
11		C0603C0G1E060D	0.60±0.03	0.30±0.03	0.30±0.03	520		1MHz	0.5-5Vrms	±0.25pF	±0.5pF	±0.75pF	±0.3pF	2.0 x R.V.	Paper	15,000	50,000		
12		C0603C0G1E6R8D	0.60±0.03	0.30±0.03	0.30±0.03	536		1MHz	0.5-5Vrms	±0.25pF	±0.5pF	±0.75pF	±0.3pF	2.0 x R.V.	Paper	15,000	50,000		
13		C0603C0G1E070D	0.60±0.03	0.30±0.03	0.30±0.03	540		1MHz	0.5-5Vrms	±0.25pF	±0.5pF	±0.75pF	±0.3pF	2.0 x R.V.	Paper	15,000	50,000		
14		C0603C0G1E080D	0.60±0.03	0.30±0.03	0.30±0.03	560		1MHz	0.5-5Vrms	±0.25pF	±0.5pF	±0.75pF	±0.3pF	2.0 x R.V.	Paper	15,000	50,000		
15		C0603C0G1E090D	0.60±0.03	0.30±0.03	0.30±0.03	580		1MHz	0.5-5Vrms	±0.25pF	±0.5pF	±0.75pF	±0.3pF	2.0 x R.V.	Paper	15,000	50,000		
16		C0603C0G1E100D	0.60±0.03	0.30±0.03	0.30±0.03	600		1MHz	0.5-5Vrms	±0.25pF	±0.5pF	±0.75pF	±0.3pF	2.0 x R.V.	Paper	15,000	50,000		
17		C0603C0G1E120J	0.60±0.03	0.30±0.03	0.30±0.03	640		1MHz	0.5-5Vrms	±2.5%	±5.0%	±7.5%	±3.0%	2.0 x R.V.	Paper	15,000	50,000		
18		C0603C0G1E150J	0.60±0.03	0.30±0.03	0.30±0.03	700		1MHz	0.5-5Vrms	±2.5%	±5.0%	±7.5%	±3.0%	2.0 x R.V.	Paper	15,000	50,000		
19		C0603C0G1E180J	0.60±0.03	0.30±0.03	0.30±0.03	760		1MHz	0.5-5Vrms	±2.5%	±5.0%	±7.5%	±3.0%	2.0 x R.V.	Paper	15,000	50,000		
20		C0603C0G1E220J	0.60±0.03	0.30±0.03	0.30±0.03	840		1MHz	0.5-5Vrms	±2.5%	±5.0%	±7.5%	±3.0%	2.0 x R.V.	Paper	15,000	50,000		
21		C0603C0G1E270J	0.60±0.03	0.30±0.03	0.30±0.03	940		1MHz	0.5-5Vrms	±2.5%	±5.0%	±7.5%	±3.0%	2.0 x R.V.	Paper	15,000	50,000		
22		C0603C0G1E330J	0.60±0.03	0.30±0.03	0.30±0.03	1,000		1MHz	0.5-5Vrms	±2.5%	±5.0%	±7.5%	±3.0%	2.0 x R.V.	Paper	15,000	50,000		
23		C0603C0G1E390J	0.60±0.03	0.30±0.03	0.30±0.03	1,000		1MHz	0.5-5Vrms	±2.5%	±5.0%	±7.5%	±3.0%	2.0 x R.V.	Paper	15,000	50,000		
24		C0603C0G1E470J	0.60±0.03	0.30±0.03	0.30±0.03	1,000		1MHz	0.5-5Vrms	±2.5%	±5.0%	±7.5%	±3.0%	2.0 x R.V.	Paper	15,000	50,000		
25		C0603C0G1E560J	0.60±0.03	0.30±0.03	0.30±0.03	1,000		1MHz	0.5-5Vrms	±2.5%	±5.0%	±7.5%	±3.0%	2.0 x R.V.	Paper	15,000	50,000		
26		C0603C0G1E680J	0.60±0.03	0.30±0.03	0.30±0.03	1,000		1MHz	0.5-5Vrms	±2.5%	±5.0%	±7.5%	±3.0%	2.0 x R.V.	Paper	15,000	50,000		
27		C0603C0G1E820J	0.60±0.03	0.30±0.03	0.30±0.03	1,000		1MHz	0.5-5Vrms	±2.5%	±5.0%	±7.5%	±3.0%	2.0 x R.V.	Paper	15,000	50,000		
28		C0603C0G1E101J	0.60±0.03	0.30±0.03	0.30±0.03	1,000		1MHz	0.5-5Vrms	±2.5%	±5.0%	±7.5%	±3.0%	2.0 x R.V.	Paper	15,000	50,000		
29		C0603X5R1E101K	0.60±0.03	0.30±0.03	0.30±0.03		0.03	1kHz	1.0Vrms	±7.5%	±12.5%	±12.5%	±15%	2.0 x R.V.	Paper	15,000	50,000		
30		C0603X5R1E151K	0.60±0.03	0.30±0.03	0.30±0.03		0.03	1kHz	1.0Vrms	±7.5%	±12.5%	±12.5%	±15%	2.0 x R.V.	Paper	15,000	50,000		
31		C0603X5R1E221K	0.60±0.03	0.30±0.03	0.30±0.03		0.03	1kHz	1.0Vrms	±7.5%	±12.5%	±12.5%	±15%	2.0 x R.V.	Paper	15,000	50,000		
32		C0603X5R1E331K	0.60±0.03	0.30±0.03	0.30±0.03		0.03	1kHz	1.0Vrms	±7.5%	±12.5%	±12.5%	±15%	2.0 x R.V.	Paper	15,000	50,000		
33		C0603X5R1E471K	0.60±0.03	0.30±0.03	0.30±0.03		0.03	1kHz	1.0Vrms	±7.5%	±12.5%	±12.5%	±15%	2.0 x R.V.	Paper	15,000	50,000		
34		C0603X5R1E681K	0.60±0.03	0.30±0.03	0.30±0.03		0.03	1kHz	1.0Vrms	±7.5%	±12.5%	±12.5%	±15%	2.0 x R.V.	Paper	15,000	50,000		
35		C0603X5R1E102K	0.60±0.03	0.30±0.03	0.30±0.03		0.03	1kHz	1.0Vrms	±7.5%	±12.5%	±12.5%	±15%	2.0 x R.V.	Paper	15,000	50,000		
36		C0603X5R1E152K	0.60±0.03	0.30±0.03	0.30±0.03		0.03	1kHz	1.0Vrms	±7.5%	±12.5%	±12.5%	±15%	2.0 x R.V.	Paper	15,000	50,000		
37		C0603X5R1E222K	0.60±0.03	0.30±0.03	0.30±0.03		0.03	1kHz	1.0Vrms	±7.5%	±12.5%	±12.5%	±15%	2.0 x R.V.	Paper	15,000	50,000		
38		C0603X5R1E332K	0.60±0.03	0.30±0.03	0.30±0.03		0.03	1kHz	1.0Vrms	±7.5%	±12.5%	±12.5%	±15%	2.0 x R.V.	Paper	15,000	50,000		
39		C0603X5R1C472K	0.60±0.03	0.30±0.03	0.30±0.03		0.05	1kHz	1.0Vrms	±7.5%	±12.5%	±12.5%	±15%	2.0 x R.V.	Paper	15,000	50,000		
40		C0603X5R1A682K	0.60±0.03	0.30±0.03	0.30±0.03		0.05	1kHz	0.2Vrms	±7.5%	±12.5%	±12.5%	±15%	2.0 x R.V.	Paper	15,000	50,000		
41		C0603X5R1A103K	0.60±0.03	0.30±0.03	0.30±0.03		0.05	1kHz	0.2Vrms	±7.5%	±12.5%	±12.5%	±15%	2.0 x R.V.	Paper	15,000	50,000		
42		C0603X5R0J153K	0.60±0.03	0.30±0.03	0.30±0.03		0.05	1kHz	0.2Vrms	±7.5%	±12.5%	±12.5%	±15%	2.0 x R.V.	Paper	15,000	50,000		
43		C0603X5R0J223K	0.60±0.03	0.30±0.03	0.30±0.03		0.10	1kHz	0.5Vrms	±15%	±25%	±25%	±25%	R.V.	Paper	15,000	50,000		
44		C0603X5R0J333K	0.60±0.03	0.30±0.03	0.30±0.03		0.10	1kHz	0.5Vrms	±15%	±25%	±25%	±25%	R.V.	Paper	15,000	50,000		
45		C0603X5R0J473K	0.60±0.03	0.30±0.03	0.30±0.03		0.10	1kHz	0.5Vrms	±15%	±25%	±25%	±25%	R.V.	Paper	15,000	50,000		
46		C0603X5R0J683K	0.60±0.03	0.30±0.03	0.30±0.03		0.10	1kHz	0.5Vrms	±15%	±25%	±25%	±25%	R.V.	Paper	15,000	50,000		
47		C0603X5R0J104K	0.60±0.03	0.30±0.03	0.30±0.03		0.10	1kHz	0.5Vrms	±15%	±25%	±25%	±25%	R.V.	Paper	15,000	50,000		

No	Your Part No.	TDK product	Dimensions			Q (min.)	tanδ (max.)	Temp. Characteristics of Cap.		Temp cycle ΔC/C	Moisture Resistance (Steady state)		Moisture Resistance		Life		Tape packaging materials	Qty. per 1 reel	
			L (mm)	W (mm)	T (mm)			Measuring frequency	Measuring voltage		ΔC/C	ΔC/C	ΔC/C	ΔC/C	Test voltage	φ178mm		φ330mm	
48		C0603Y5V1C103Z	0.60±0.03	0.30±0.03	0.30±0.03		0.10	1kHz	1.0Vrms	±20%	±30%	±30%	±30%	2.0 x R.V.	Paper	15,000	50,000		
49		C1005C0G1H0R5C	1.00±0.05	0.50±0.05	0.50±0.05	410		1MHz	0.5-5Vrms	±0.25pF	±0.5pF	±0.75pF	±0.3pF	2.0 x R.V.	Paper	10,000	50,000		
50		C1005C0G1H010C	1.00±0.05	0.50±0.05	0.50±0.05	420		1MHz	0.5-5Vrms	±0.25pF	±0.5pF	±0.75pF	±0.3pF	2.0 x R.V.	Paper	10,000	50,000		
51		C1005C0G1H1R5C	1.00±0.05	0.50±0.05	0.50±0.05	430		1MHz	0.5-5Vrms	±0.25pF	±0.5pF	±0.75pF	±0.3pF	2.0 x R.V.	Paper	10,000	50,000		
52		C1005C0G1H020C	1.00±0.05	0.50±0.05	0.50±0.05	440		1MHz	0.5-5Vrms	±0.25pF	±0.5pF	±0.75pF	±0.3pF	2.0 x R.V.	Paper	10,000	50,000		
53		C1005C0G1H2R2C	1.00±0.05	0.50±0.05	0.50±0.05	444		1MHz	0.5-5Vrms	±0.25pF	±0.5pF	±0.75pF	±0.3pF	2.0 x R.V.	Paper	10,000	50,000		
54		C1005C0G1H030C	1.00±0.05	0.50±0.05	0.50±0.05	460		1MHz	0.5-5Vrms	±0.25pF	±0.5pF	±0.75pF	±0.3pF	2.0 x R.V.	Paper	10,000	50,000		
55		C1005C0G1H3R3C	1.00±0.05	0.50±0.05	0.50±0.05	466		1MHz	0.5-5Vrms	±0.25pF	±0.5pF	±0.75pF	±0.3pF	2.0 x R.V.	Paper	10,000	50,000		
56		C1005C0G1H040C	1.00±0.05	0.50±0.05	0.50±0.05	480		1MHz	0.5-5Vrms	±0.25pF	±0.5pF	±0.75pF	±0.3pF	2.0 x R.V.	Paper	10,000	50,000		
57		C1005C0G1H4R7C	1.00±0.05	0.50±0.05	0.50±0.05	494		1MHz	0.5-5Vrms	±0.25pF	±0.5pF	±0.75pF	±0.3pF	2.0 x R.V.	Paper	10,000	50,000		
58		C1005C0G1H050C	1.00±0.05	0.50±0.05	0.50±0.05	500		1MHz	0.5-5Vrms	±0.25pF	±0.5pF	±0.75pF	±0.3pF	2.0 x R.V.	Paper	10,000	50,000		
59		C1005C0G1H060D	1.00±0.05	0.50±0.05	0.50±0.05	520		1MHz	0.5-5Vrms	±0.25pF	±0.5pF	±0.75pF	±0.3pF	2.0 x R.V.	Paper	10,000	50,000		
60		C1005C0G1H6R8D	1.00±0.05	0.50±0.05	0.50±0.05	536		1MHz	0.5-5Vrms	±0.25pF	±0.5pF	±0.75pF	±0.3pF	2.0 x R.V.	Paper	10,000	50,000		
61		C1005C0G1H070D	1.00±0.05	0.50±0.05	0.50±0.05	540		1MHz	0.5-5Vrms	±0.25pF	±0.5pF	±0.75pF	±0.3pF	2.0 x R.V.	Paper	10,000	50,000		
62		C1005C0G1H080D	1.00±0.05	0.50±0.05	0.50±0.05	560		1MHz	0.5-5Vrms	±0.25pF	±0.5pF	±0.75pF	±0.3pF	2.0 x R.V.	Paper	10,000	50,000		
63		C1005C0G1H090D	1.00±0.05	0.50±0.05	0.50±0.05	580		1MHz	0.5-5Vrms	±0.25pF	±0.5pF	±0.75pF	±0.3pF	2.0 x R.V.	Paper	10,000	50,000		
64		C1005C0G1H100D	1.00±0.05	0.50±0.05	0.50±0.05	600		1MHz	0.5-5Vrms	±0.25pF	±0.5pF	±0.75pF	±0.3pF	2.0 x R.V.	Paper	10,000	50,000		
65		C1005C0G1H120J	1.00±0.05	0.50±0.05	0.50±0.05	640		1MHz	0.5-5Vrms	±2.5%	±5.0%	±7.5%	±3.0%	2.0 x R.V.	Paper	10,000	50,000		
66		C1005C0G1H150J	1.00±0.05	0.50±0.05	0.50±0.05	700		1MHz	0.5-5Vrms	±2.5%	±5.0%	±7.5%	±3.0%	2.0 x R.V.	Paper	10,000	50,000		
67		C1005C0G1H180J	1.00±0.05	0.50±0.05	0.50±0.05	760		1MHz	0.5-5Vrms	±2.5%	±5.0%	±7.5%	±3.0%	2.0 x R.V.	Paper	10,000	50,000		
68		C1005C0G1H220J	1.00±0.05	0.50±0.05	0.50±0.05	840		1MHz	0.5-5Vrms	±2.5%	±5.0%	±7.5%	±3.0%	2.0 x R.V.	Paper	10,000	50,000		
69		C1005C0G1H270J	1.00±0.05	0.50±0.05	0.50±0.05	940		1MHz	0.5-5Vrms	±2.5%	±5.0%	±7.5%	±3.0%	2.0 x R.V.	Paper	10,000	50,000		
70		C1005C0G1H330J	1.00±0.05	0.50±0.05	0.50±0.05	1,000		1MHz	0.5-5Vrms	±2.5%	±5.0%	±7.5%	±3.0%	2.0 x R.V.	Paper	10,000	50,000		
71		C1005C0G1H390J	1.00±0.05	0.50±0.05	0.50±0.05	1,000		1MHz	0.5-5Vrms	±2.5%	±5.0%	±7.5%	±3.0%	2.0 x R.V.	Paper	10,000	50,000		
72		C1005C0G1H470J	1.00±0.05	0.50±0.05	0.50±0.05	1,000		1MHz	0.5-5Vrms	±2.5%	±5.0%	±7.5%	±3.0%	2.0 x R.V.	Paper	10,000	50,000		
73		C1005C0G1H560J	1.00±0.05	0.50±0.05	0.50±0.05	1,000		1MHz	0.5-5Vrms	±2.5%	±5.0%	±7.5%	±3.0%	2.0 x R.V.	Paper	10,000	50,000		
74		C1005C0G1H680J	1.00±0.05	0.50±0.05	0.50±0.05	1,000		1MHz	0.5-5Vrms	±2.5%	±5.0%	±7.5%	±3.0%	2.0 x R.V.	Paper	10,000	50,000		
75		C1005C0G1H820J	1.00±0.05	0.50±0.05	0.50±0.05	1,000		1MHz	0.5-5Vrms	±2.5%	±5.0%	±7.5%	±3.0%	2.0 x R.V.	Paper	10,000	50,000		
76		C1005C0G1H101J	1.00±0.05	0.50±0.05	0.50±0.05	1,000		1MHz	0.5-5Vrms	±2.5%	±5.0%	±7.5%	±3.0%	2.0 x R.V.	Paper	10,000	50,000		
77		C1005C0G1H121J	1.00±0.05	0.50±0.05	0.50±0.05	1,000		1MHz	0.5-5Vrms	±2.5%	±5.0%	±7.5%	±3.0%	2.0 x R.V.	Paper	10,000	50,000		
78		C1005C0G1H151J	1.00±0.05	0.50±0.05	0.50±0.05	1,000		1MHz	0.5-5Vrms	±2.5%	±5.0%	±7.5%	±3.0%	2.0 x R.V.	Paper	10,000	50,000		
79		C1005C0G1H181J	1.00±0.05	0.50±0.05	0.50±0.05	1,000		1MHz	0.5-5Vrms	±2.5%	±5.0%	±7.5%	±3.0%	2.0 x R.V.	Paper	10,000	50,000		
80		C1005C0G1H221J	1.00±0.05	0.50±0.05	0.50±0.05	1,000		1MHz	0.5-5Vrms	±2.5%	±5.0%	±7.5%	±3.0%	2.0 x R.V.	Paper	10,000	50,000		
81		C1005C0G1H271J	1.00±0.05	0.50±0.05	0.50±0.05	1,000		1MHz	0.5-5Vrms	±2.5%	±5.0%	±7.5%	±3.0%	2.0 x R.V.	Paper	10,000	50,000		
82		C1005C0G1H331J	1.00±0.05	0.50±0.05	0.50±0.05	1,000		1MHz	0.5-5Vrms	±2.5%	±5.0%	±7.5%	±3.0%	2.0 x R.V.	Paper	10,000	50,000		
83		C1005C0G1H391J	1.00±0.05	0.50±0.05	0.50±0.05	1,000		1MHz	0.5-5Vrms	±2.5%	±5.0%	±7.5%	±3.0%	2.0 x R.V.	Paper	10,000	50,000		
84		C1005C0G1H471J	1.00±0.05	0.50±0.05	0.50±0.05	1,000		1MHz	0.5-5Vrms	±2.5%	±5.0%	±7.5%	±3.0%	2.0 x R.V.	Paper	10,000	50,000		

No	Your Part No.	TDK product	Dimensions			Q (min.)	tanδ (max.)	Temp. Characteristics of Cap.		Temp cycle ΔC/C	Moisture Resistance (Steady state) ΔC/C	Moisture Resistance ΔC/C	Life		Tape packaging materials	Qty. per 1 reel	
			L (mm)	W (mm)	T (mm)			Measuring frequency	Measuring voltage				ΔC/C	Test voltage		φ178mm	φ330mm
85		C1005X5R1E333K	1.00±0.05	0.50±0.05	0.50±0.05		0.03	1kHz	1.0Vrms	±12.5%	±25%	±25%	±25%	2.0 x R.V.	Paper	10,000	50,000
86		C1005X5R1E473K	1.00±0.05	0.50±0.05	0.50±0.05		0.03	1kHz	1.0Vrms	±12.5%	±25%	±25%	±25%	2.0 x R.V.	Paper	10,000	50,000
87		C1005X5R1E683K	1.00±0.05	0.50±0.05	0.50±0.05		0.05	1kHz	0.1Vrms	±12.5%	±25%	±25%	±25%	R.V.	Paper	10,000	50,000
88		C1005X5R1E104K	1.00±0.05	0.50±0.05	0.50±0.05		0.05	1kHz	0.1Vrms	±12.5%	±25%	±25%	±25%	R.V.	Paper	10,000	50,000
89		C1005X5R1C683K	1.00±0.05	0.50±0.05	0.50±0.05		0.05	1kHz	0.1Vrms	±12.5%	±25%	±25%	±25%	2.0 x R.V.	Paper	10,000	50,000
90		C1005X5R1C104K	1.00±0.05	0.50±0.05	0.50±0.05		0.05	1kHz	0.1Vrms	±12.5%	±25%	±25%	±25%	2.0 x R.V.	Paper	10,000	50,000
91		C1005X5R1C154K	1.00±0.05	0.50±0.05	0.50±0.05		0.05	1kHz	1.0Vrms	±12.5%	±25%	±25%	±25%	1.5 x R.V.	Paper	10,000	50,000
92		C1005X5R1C224K	1.00±0.05	0.50±0.05	0.50±0.05		0.05	1kHz	1.0Vrms	±12.5%	±25%	±25%	±25%	1.5 x R.V.	Paper	10,000	50,000
93		C1005X5R1C334K	1.00±0.05	0.50±0.05	0.50±0.05		0.10	1kHz	1.0Vrms	±12.5%	±25%	±25%	±25%	R.V.	Paper	10,000	50,000
94		C1005X5R1C474K	1.00±0.05	0.50±0.05	0.50±0.05		0.10	1kHz	1.0Vrms	±12.5%	±25%	±25%	±25%	R.V.	Paper	10,000	50,000
95		C1005X5R1C684K	1.00±0.05	0.50±0.05	0.50±0.05		0.10	1kHz	1.0Vrms	±12.5%	±25%	±25%	±25%	R.V.	Paper	10,000	50,000
96		C1005X5R1C105K	1.00±0.05	0.50±0.05	0.50±0.05		0.10	1kHz	1.0Vrms	±12.5%	±25%	±25%	±25%	R.V.	Paper	10,000	50,000
97		C1005X5R1A154K	1.00±0.05	0.50±0.05	0.50±0.05		0.10	1kHz	0.5Vrms	±15%	±25%	±25%	±25%	R.V.	Paper	10,000	50,000
98		C1005X5R1A224K	1.00±0.05	0.50±0.05	0.50±0.05		0.10	1kHz	0.5Vrms	±15%	±25%	±25%	±25%	R.V.	Paper	10,000	50,000
99		C1005X5R1A334K	1.00±0.05	0.50±0.05	0.50±0.05		0.10	1kHz	0.5Vrms	±15%	±25%	±25%	±25%	R.V.	Paper	10,000	50,000
100		C1005X5R1A474K	1.00±0.05	0.50±0.05	0.50±0.05		0.10	1kHz	0.5Vrms	±15%	±25%	±25%	±25%	R.V.	Paper	10,000	50,000
101		C1005X5R1A684K	1.00±0.05	0.50±0.05	0.50±0.05		0.10	1kHz	0.5Vrms	±15%	±25%	±25%	±25%	R.V.	Paper	10,000	50,000
102		C1005X5R1A105K	1.00±0.05	0.50±0.05	0.50±0.05		0.10	1kHz	0.5Vrms	±15%	±25%	±25%	±25%	R.V.	Paper	10,000	50,000
103		C1005X5R0J154K	1.00±0.05	0.50±0.05	0.50±0.05		0.10	1kHz	0.5Vrms	±15%	±25%	±25%	±25%	1.5 x R.V.	Paper	10,000	50,000
104		C1005X5R0J224K	1.00±0.05	0.50±0.05	0.50±0.05		0.10	1kHz	0.5Vrms	±15%	±25%	±25%	±25%	1.5 x R.V.	Paper	10,000	50,000
105		C1005X5R0J334K	1.00±0.05	0.50±0.05	0.50±0.05		0.10	1kHz	0.5Vrms	±15%	±25%	±25%	±25%	1.5 x R.V.	Paper	10,000	50,000
106		C1005X5R0J474K	1.00±0.05	0.50±0.05	0.50±0.05		0.10	1kHz	0.5Vrms	±15%	±25%	±25%	±25%	1.5 x R.V.	Paper	10,000	50,000
107		C1005X5R0J684K	1.00±0.05	0.50±0.05	0.50±0.05		0.10	1kHz	0.5Vrms	±15%	±25%	±25%	±25%	R.V.	Paper	10,000	50,000
108		C1005X5R0J105K	1.00±0.05	0.50±0.05	0.50±0.05		0.10	1kHz	0.5Vrms	±15%	±25%	±25%	±25%	R.V.	Paper	10,000	50,000
109		C1005X5R0J155M	1.00±0.05	0.50±0.05	0.50±0.05		0.10	1kHz	0.5Vrms	±12.5%	±25%	±25%	±25%	1.5 x R.V.	Paper	10,000	50,000
110		C1005X5R0J225M	1.00±0.05	0.50±0.05	0.50±0.05		0.10	1kHz	0.5Vrms	±12.5%	±25%	±25%	±25%	1.5 x R.V.	Paper	10,000	50,000
111		C1005X7R1H221K	1.00±0.05	0.50±0.05	0.50±0.05		0.03	1kHz	1.0Vrms	±7.5%	±12.5%	±12.5%	±15%	2.0 x R.V.	Paper	10,000	50,000
112		C1005X7R1H331K	1.00±0.05	0.50±0.05	0.50±0.05		0.03	1kHz	1.0Vrms	±7.5%	±12.5%	±12.5%	±15%	2.0 x R.V.	Paper	10,000	50,000
113		C1005X7R1H471K	1.00±0.05	0.50±0.05	0.50±0.05		0.03	1kHz	1.0Vrms	±7.5%	±12.5%	±12.5%	±15%	2.0 x R.V.	Paper	10,000	50,000
114		C1005X7R1H681K	1.00±0.05	0.50±0.05	0.50±0.05		0.03	1kHz	1.0Vrms	±7.5%	±12.5%	±12.5%	±15%	2.0 x R.V.	Paper	10,000	50,000
115		C1005X7R1H102K	1.00±0.05	0.50±0.05	0.50±0.05		0.03	1kHz	1.0Vrms	±7.5%	±12.5%	±12.5%	±15%	2.0 x R.V.	Paper	10,000	50,000
116		C1005X7R1H152K	1.00±0.05	0.50±0.05	0.50±0.05		0.03	1kHz	1.0Vrms	±7.5%	±12.5%	±12.5%	±15%	2.0 x R.V.	Paper	10,000	50,000
117		C1005X7R1H222K	1.00±0.05	0.50±0.05	0.50±0.05		0.03	1kHz	1.0Vrms	±7.5%	±12.5%	±12.5%	±15%	2.0 x R.V.	Paper	10,000	50,000
118		C1005X7R1H332K	1.00±0.05	0.50±0.05	0.50±0.05		0.03	1kHz	1.0Vrms	±7.5%	±12.5%	±12.5%	±15%	2.0 x R.V.	Paper	10,000	50,000
119		C1005X7R1H472K	1.00±0.05	0.50±0.05	0.50±0.05		0.03	1kHz	1.0Vrms	±7.5%	±12.5%	±12.5%	±15%	2.0 x R.V.	Paper	10,000	50,000
120		C1005X7R1H682K	1.00±0.05	0.50±0.05	0.50±0.05		0.03	1kHz	1.0Vrms	±7.5%	±12.5%	±12.5%	±15%	2.0 x R.V.	Paper	10,000	50,000
121		C1005X7R1E103K	1.00±0.05	0.50±0.05	0.50±0.05		0.03	1kHz	1.0Vrms	±7.5%	±12.5%	±12.5%	±15%	2.0 x R.V.	Paper	10,000	50,000
122		C1005X7R1E153K	1.00±0.05	0.50±0.05	0.50±0.05		0.03	1kHz	1.0Vrms	±7.5%	±12.5%	±12.5%	±15%	2.0 x R.V.	Paper	10,000	50,000
123		C1005X7R1E223K	1.00±0.05	0.50±0.05	0.50±0.05		0.03	1kHz	1.0Vrms	±7.5%	±12.5%	±12.5%	±15%	2.0 x R.V.	Paper	10,000	50,000
124		C1005X7R1E333K	1.00±0.05	0.50±0.05	0.50±0.05		0.03	1kHz	1.0Vrms	±12.5%	±25%	±25%	±25%	R.V.	Paper	10,000	50,000
125		C1005X7R1E473K	1.00±0.05	0.50±0.05	0.50±0.05		0.03	1kHz	1.0Vrms	±12.5%	±25%	±25%	±25%	R.V.	Paper	10,000	50,000
126		C1005X7R1C683K	1.00±0.05	0.50±0.05	0.50±0.05		0.05	1kHz	0.1Vrms	±12.5%	±25%	±25%	±25%	R.V.	Paper	10,000	50,000
127		C1005X7R1C104K	1.00±0.05	0.50±0.05	0.50±0.05		0.05	1kHz	0.1Vrms	±12.5%	±25%	±25%	±25%	R.V.	Paper	10,000	50,000

No	Your Part No.	TDK product	Dimensions			Q (min.)	tanδ (max.)	Temp. Characteristics of Cap.		Temp cycle ΔC/C	Moisture Resistance (Steady state)		Moisture Resistance ΔC/C	Life		Tape packaging materials	Qty. per 1 reel	
			L (mm)	W (mm)	T (mm)			Measuring frequency	Measuring voltage		ΔC/C	ΔC/C		ΔC/C	ΔC/C		Test voltage	φ178mm
128		C1005Y5V1E104Z	1.00±0.05	0.50±0.05	0.50±0.05		0.075	1kHz	1.0Vrms	±20%	±30%	±30%	±30%	2.0 x R.V.	Paper	10,000	50,000	
129		C1005Y5V1E224Z	1.00±0.05	0.50±0.05	0.50±0.05		0.075	1kHz	1.0Vrms	±20%	±30%	±30%	±30%	2.0 x R.V.	Paper	10,000	50,000	
130		C1005Y5V1A474Z	1.00±0.05	0.50±0.05	0.50±0.05		0.125	1kHz	0.2Vrms	±20%	±30%	±30%	±30%	2.0 x R.V.	Paper	10,000	50,000	
131		C1005Y5V0J105Z	1.00±0.05	0.50±0.05	0.50±0.05		0.20	1kHz	0.2Vrms	±20%	±30%	±40%	±40%	2.0 x R.V.	Paper	10,000	50,000	
132		C1608C0G1H0R5C	1.60±0.10	0.80±0.10	0.80±0.10	410		1MHz	0.5-5Vrms	±0.25pF	±0.5pF	±0.75pF	±0.3pF	2.0 x R.V.	Paper	4,000	10,000	
133		C1608C0G1H010C	1.60±0.10	0.80±0.10	0.80±0.10	420		1MHz	0.5-5Vrms	±0.25pF	±0.5pF	±0.75pF	±0.3pF	2.0 x R.V.	Paper	4,000	10,000	
134		C1608C0G1H1R5C	1.60±0.10	0.80±0.10	0.80±0.10	430		1MHz	0.5-5Vrms	±0.25pF	±0.5pF	±0.75pF	±0.3pF	2.0 x R.V.	Paper	4,000	10,000	
135		C1608C0G1H020C	1.60±0.10	0.80±0.10	0.80±0.10	440		1MHz	0.5-5Vrms	±0.25pF	±0.5pF	±0.75pF	±0.3pF	2.0 x R.V.	Paper	4,000	10,000	
136		C1608C0G1H2R2C	1.60±0.10	0.80±0.10	0.80±0.10	444		1MHz	0.5-5Vrms	±0.25pF	±0.5pF	±0.75pF	±0.3pF	2.0 x R.V.	Paper	4,000	10,000	
137		C1608C0G1H030C	1.60±0.10	0.80±0.10	0.80±0.10	460		1MHz	0.5-5Vrms	±0.25pF	±0.5pF	±0.75pF	±0.3pF	2.0 x R.V.	Paper	4,000	10,000	
138		C1608C0G1H3R3C	1.60±0.10	0.80±0.10	0.80±0.10	466		1MHz	0.5-5Vrms	±0.25pF	±0.5pF	±0.75pF	±0.3pF	2.0 x R.V.	Paper	4,000	10,000	
139		C1608C0G1H040C	1.60±0.10	0.80±0.10	0.80±0.10	480		1MHz	0.5-5Vrms	±0.25pF	±0.5pF	±0.75pF	±0.3pF	2.0 x R.V.	Paper	4,000	10,000	
140		C1608C0G1H4R7C	1.60±0.10	0.80±0.10	0.80±0.10	494		1MHz	0.5-5Vrms	±0.25pF	±0.5pF	±0.75pF	±0.3pF	2.0 x R.V.	Paper	4,000	10,000	
141		C1608C0G1H050C	1.60±0.10	0.80±0.10	0.80±0.10	500		1MHz	0.5-5Vrms	±0.25pF	±0.5pF	±0.75pF	±0.3pF	2.0 x R.V.	Paper	4,000	10,000	
142		C1608C0G1H060D	1.60±0.10	0.80±0.10	0.80±0.10	520		1MHz	0.5-5Vrms	±0.25pF	±0.5pF	±0.75pF	±0.3pF	2.0 x R.V.	Paper	4,000	10,000	
143		C1608C0G1H6R8D	1.60±0.10	0.80±0.10	0.80±0.10	536		1MHz	0.5-5Vrms	±0.25pF	±0.5pF	±0.75pF	±0.3pF	2.0 x R.V.	Paper	4,000	10,000	
144		C1608C0G1H070D	1.60±0.10	0.80±0.10	0.80±0.10	540		1MHz	0.5-5Vrms	±0.25pF	±0.5pF	±0.75pF	±0.3pF	2.0 x R.V.	Paper	4,000	10,000	
145		C1608C0G1H080D	1.60±0.10	0.80±0.10	0.80±0.10	560		1MHz	0.5-5Vrms	±0.25pF	±0.5pF	±0.75pF	±0.3pF	2.0 x R.V.	Paper	4,000	10,000	
146		C1608C0G1H090D	1.60±0.10	0.80±0.10	0.80±0.10	580		1MHz	0.5-5Vrms	±0.25pF	±0.5pF	±0.75pF	±0.3pF	2.0 x R.V.	Paper	4,000	10,000	
147		C1608C0G1H100D	1.60±0.10	0.80±0.10	0.80±0.10	600		1MHz	0.5-5Vrms	±0.25pF	±0.5pF	±0.75pF	±0.3pF	2.0 x R.V.	Paper	4,000	10,000	
148		C1608C0G1H120J	1.60±0.10	0.80±0.10	0.80±0.10	640		1MHz	0.5-5Vrms	±2.5%	±5.0%	±7.5%	±3.0%	2.0 x R.V.	Paper	4,000	10,000	
149		C1608C0G1H150J	1.60±0.10	0.80±0.10	0.80±0.10	700		1MHz	0.5-5Vrms	±2.5%	±5.0%	±7.5%	±3.0%	2.0 x R.V.	Paper	4,000	10,000	
150		C1608C0G1H180J	1.60±0.10	0.80±0.10	0.80±0.10	760		1MHz	0.5-5Vrms	±2.5%	±5.0%	±7.5%	±3.0%	2.0 x R.V.	Paper	4,000	10,000	
151		C1608C0G1H220J	1.60±0.10	0.80±0.10	0.80±0.10	840		1MHz	0.5-5Vrms	±2.5%	±5.0%	±7.5%	±3.0%	2.0 x R.V.	Paper	4,000	10,000	
152		C1608C0G1H270J	1.60±0.10	0.80±0.10	0.80±0.10	940		1MHz	0.5-5Vrms	±2.5%	±5.0%	±7.5%	±3.0%	2.0 x R.V.	Paper	4,000	10,000	
153		C1608C0G1H330J	1.60±0.10	0.80±0.10	0.80±0.10	1,000		1MHz	0.5-5Vrms	±2.5%	±5.0%	±7.5%	±3.0%	2.0 x R.V.	Paper	4,000	10,000	
154		C1608C0G1H390J	1.60±0.10	0.80±0.10	0.80±0.10	1,000		1MHz	0.5-5Vrms	±2.5%	±5.0%	±7.5%	±3.0%	2.0 x R.V.	Paper	4,000	10,000	
155		C1608C0G1H470J	1.60±0.10	0.80±0.10	0.80±0.10	1,000		1MHz	0.5-5Vrms	±2.5%	±5.0%	±7.5%	±3.0%	2.0 x R.V.	Paper	4,000	10,000	
156		C1608C0G1H560J	1.60±0.10	0.80±0.10	0.80±0.10	1,000		1MHz	0.5-5Vrms	±2.5%	±5.0%	±7.5%	±3.0%	2.0 x R.V.	Paper	4,000	10,000	
157		C1608C0G1H680J	1.60±0.10	0.80±0.10	0.80±0.10	1,000		1MHz	0.5-5Vrms	±2.5%	±5.0%	±7.5%	±3.0%	2.0 x R.V.	Paper	4,000	10,000	
158		C1608C0G1H820J	1.60±0.10	0.80±0.10	0.80±0.10	1,000		1MHz	0.5-5Vrms	±2.5%	±5.0%	±7.5%	±3.0%	2.0 x R.V.	Paper	4,000	10,000	
159		C1608C0G1H101J	1.60±0.10	0.80±0.10	0.80±0.10	1,000		1MHz	0.5-5Vrms	±2.5%	±5.0%	±7.5%	±3.0%	2.0 x R.V.	Paper	4,000	10,000	
160		C1608C0G1H121J	1.60±0.10	0.80±0.10	0.80±0.10	1,000		1MHz	0.5-5Vrms	±2.5%	±5.0%	±7.5%	±3.0%	2.0 x R.V.	Paper	4,000	10,000	
161		C1608C0G1H151J	1.60±0.10	0.80±0.10	0.80±0.10	1,000		1MHz	0.5-5Vrms	±2.5%	±5.0%	±7.5%	±3.0%	2.0 x R.V.	Paper	4,000	10,000	
162		C1608C0G1H181J	1.60±0.10	0.80±0.10	0.80±0.10	1,000		1MHz	0.5-5Vrms	±2.5%	±5.0%	±7.5%	±3.0%	2.0 x R.V.	Paper	4,000	10,000	
163		C1608C0G1H221J	1.60±0.10	0.80±0.10	0.80±0.10	1,000		1MHz	0.5-5Vrms	±2.5%	±5.0%	±7.5%	±3.0%	2.0 x R.V.	Paper	4,000	10,000	
164		C1608C0G1H271J	1.60±0.10	0.80±0.10	0.80±0.10	1,000		1MHz	0.5-5Vrms	±2.5%	±5.0%	±7.5%	±3.0%	2.0 x R.V.	Paper	4,000	10,000	
165		C1608C0G1H331J	1.60±0.10	0.80±0.10	0.80±0.10	1,000		1MHz	0.5-5Vrms	±2.5%	±5.0%	±7.5%	±3.0%	2.0 x R.V.	Paper	4,000	10,000	
166		C1608C0G1H391J	1.60±0.10	0.80±0.10	0.80±0.10	1,000		1MHz	0.5-5Vrms	±2.5%	±5.0%	±7.5%	±3.0%	2.0 x R.V.	Paper	4,000	10,000	
167		C1608C0G1H471J	1.60±0.10	0.80±0.10	0.80±0.10	1,000		1MHz	0.5-5Vrms	±2.5%	±5.0%	±7.5%	±3.0%	2.0 x R.V.	Paper	4,000	10,000	
168		C1608C0G1H561J	1.60±0.10	0.80±0.10	0.80±0.10	1,000		1MHz	0.5-5Vrms	±2.5%	±5.0%	±7.5%	±3.0%	2.0 x R.V.	Paper	4,000	10,000	
169		C1608C0G1H681J	1.60±0.10	0.80±0.10	0.80±0.10	1,000		1MHz	0.5-5Vrms	±2.5%	±5.0%	±7.5%	±3.0%	2.0 x R.V.	Paper	4,000	10,000	
170		C1608C0G1H821J	1.60±0.10	0.80±0.10	0.80±0.10	1,000		1MHz	0.5-5Vrms	±2.5%	±5.0%	±7.5%	±3.0%	2.0 x R.V.	Paper	4,000	10,000	
171		C1608C0G1H102J	1.60±0.10	0.80±0.10	0.80±0.10	1,000		1MHz	0.5-5Vrms	±2.5%	±5.0%	±7.5%	±3.0%	2.0 x R.V.	Paper	4,000	10,000	
172		C1608C0G1H122J	1.60±0.10	0.80±0.10	0.80±0.10	1,000		1kHz	0.5-5Vrms	±2.5%	±5.0%	±7.5%	±3.0%	2.0 x R.V.	Paper	4,000	10,000	
173		C1608C0G1H152J	1.60±0.10	0.80±0.10	0.80±0.10	1,000		1kHz	0.5-5Vrms	±2.5%	±5.0%	±7.5%	±3.0%	2.0 x R.V.	Paper	4,000	10,000	
174		C1608C0G1H182J	1.60±0.10	0.80±0.10	0.80±0.10	1,000		1kHz	0.5-5Vrms	±2.5%	±5.0%	±7.5%	±3.0%	2.0 x R.V.	Paper	4,000	10,000	
175		C1608C0G1H222J	1.60±0.10	0.80±0.10	0.80±0.10	1,000		1kHz	0.5-5Vrms	±2.5%	±5.0%	±7.5%	±3.0%	2.0 x R.V.	Paper	4,000	10,000	
176		C1608C0G1H272J	1.60±0.10	0.80±0.10	0.80±0.10	1,000		1kHz	0.5-5Vrms	±2.5%	±5.0%	±7.5%	±3.0%	2.0 x R.V.	Paper	4,000	10,000	
177		C1608C0G1H332J	1.60±0.10	0.80±0.10	0.80±0.10	1,000		1kHz	0.5-5Vrms	±2.5%	±5.0%	±7.5%	±3.0%	2.0 x R.V.	Paper	4,000	10,000	

No	Your Part No.	TDK product	Dimensions			Q (min.)	tanδ (max.)	Temp. Characteristics of Cap.		Temp cycle ΔC/C	Moisture Resistance (Steady state)		Moisture Resistance		Life		Tape packaging materials	Qty. per 1 reel	
			L (mm)	W (mm)	T (mm)			Measuring frequency	Measuring voltage		ΔC/C	ΔC/C	ΔC/C	ΔC/C	Test voltage	φ178mm		φ330mm	
178		C1608X5R1E224K	1.60±0.10	0.80±0.10	0.80±0.10		0.03	1kHz	1.0Vrms	±12.5%	±25%	±25%	±25%	2.0 x R.V.	Paper	4,000	10,000		
179		C1608X5R1E334K	1.60±0.10	0.80±0.10	0.80±0.10		0.05	1kHz	1.0Vrms	±12.5%	±25%	±25%	±25%	R.V.	Paper	4,000	10,000		
180		C1608X5R1E474K	1.60±0.10	0.80±0.10	0.80±0.10		0.05	1kHz	0.1Vrms	±12.5%	±25%	±25%	±25%	R.V.	Paper	4,000	10,000		
181		C1608X5R1E684K	1.60±0.10	0.80±0.10	0.80±0.10		0.05	1kHz	0.1Vrms	±12.5%	±25%	±25%	±25%	R.V.	Paper	4,000	10,000		
182		C1608X5R1E105K	1.60±0.10	0.80±0.10	0.80±0.10		0.05	1kHz	0.1Vrms	±12.5%	±25%	±25%	±25%	R.V.	Paper	4,000	10,000		
183		C1608X5R1C474K	1.60±0.10	0.80±0.10	0.80±0.10		0.05	1kHz	0.1Vrms	±12.5%	±25%	±25%	±25%	2.0 x R.V.	Paper	4,000	10,000		
184		C1608X5R1C684K	1.60±0.10	0.80±0.10	0.80±0.10		0.05	1kHz	0.1Vrms	±12.5%	±25%	±25%	±25%	2.0 x R.V.	Paper	4,000	10,000		
185		C1608X5R1C105K	1.60±0.10	0.80±0.10	0.80±0.10		0.05	1kHz	0.1Vrms	±12.5%	±25%	±25%	±25%	2.0 x R.V.	Paper	4,000	10,000		
186		C1608X5R1C155K	1.60±0.10	0.80±0.10	0.80±0.10		0.05	1kHz	1.0Vrms	±12.5%	±25%	±25%	±25%	1.5 x R.V.	Paper	4,000	10,000		
187		C1608X5R1C225K	1.60±0.10	0.80±0.10	0.80±0.10		0.05	1kHz	1.0Vrms	±12.5%	±25%	±25%	±25%	1.5 x R.V.	Paper	4,000	10,000		
188		C1608X5R1A684K	1.60+0.15/-0.10	0.80+0.15/-0.10	0.80+0.15/-0.10		0.05	1kHz	0.2Vrms	±7.5%	±12.5%	±12.5%	±15%	2.0 x R.V.	Paper	4,000	10,000		
189		C1608X5R1A105K	1.60+0.15/-0.10	0.80+0.15/-0.10	0.80+0.15/-0.10		0.05	1kHz	0.2Vrms	±7.5%	±12.5%	±12.5%	±15%	2.0 x R.V.	Paper	4,000	10,000		
190		C1608X5R1A155K	1.60+0.15/-0.10	0.80+0.15/-0.10	0.80+0.15/-0.10		0.10	1kHz	0.5Vrms	±15%	±25%	±25%	±25%	R.V.	Paper	4,000	10,000		
191		C1608X5R1A225K	1.60+0.15/-0.10	0.80+0.15/-0.10	0.80+0.15/-0.10		0.10	1kHz	0.2Vrms	±15%	±25%	±25%	±25%	R.V.	Paper	4,000	10,000		
192		C1608X5R1A335K	1.60±0.10	0.80±0.10	0.80±0.10		0.10	1kHz	0.2Vrms	±12.5%	±25%	±25%	±25%	1.5 x R.V.	Paper	4,000	10,000		
193		C1608X5R1A475K	1.60±0.10	0.80±0.10	0.80±0.10		0.10	1kHz	0.2Vrms	±12.5%	±25%	±25%	±25%	R.V.	Paper	4,000	10,000		
194		C1608X5R0J105K	1.60±0.10	0.80±0.10	0.80±0.10		0.05	1kHz	0.2Vrms	±7.5%	±12.5%	±12.5%	±15%	2.0 x R.V.	Paper	4,000	10,000		
195		C1608X5R0J155K	1.60±0.10	0.80±0.10	0.80±0.10		0.10	1kHz	0.5Vrms	±15%	±25%	±25%	±25%	1.5 x R.V.	Paper	4,000	10,000		
196		C1608X5R0J225K	1.60±0.10	0.80±0.10	0.80±0.10		0.10	1kHz	0.2Vrms	±15%	±25%	±25%	±25%	1.5 x R.V.	Paper	4,000	10,000		
197		C1608X5R0J335K	1.60+0.15/-0.10	0.80+0.15/-0.10	0.80+0.15/-0.10		0.10	1kHz	0.5Vrms	±15%	±25%	±25%	±25%	R.V.	Paper	4,000	10,000		
198		C1608X5R0J475K	1.60+0.15/-0.10	0.80+0.15/-0.10	0.80+0.15/-0.10		0.10	1kHz	0.5Vrms	±15%	±25%	±25%	±25%	R.V.	Paper	4,000	10,000		
199		C1608X5R0J685K	1.60 +0.20/-0.10	0.80 +0.20/-0.10	0.80 +0.20/-0.10		0.10	1kHz	0.2Vrms	±12.5%	±25%	±25%	±25%	R.V.	Paper	4,000	10,000		
200		C1608X5R0J106M	1.60 +0.20/-0.10	0.80 +0.20/-0.10	0.80 +0.20/-0.10		0.10	1kHz	0.2Vrms	±12.5%	±25%	±25%	±25%	R.V.	Paper	4,000	10,000		
201		C1608X7R1H102K	1.60±0.10	0.80±0.10	0.80±0.10		0.03	1kHz	1.0Vrms	±7.5%	±12.5%	±12.5%	±15%	2.0 x R.V.	Paper	4,000	10,000		
202		C1608X7R1H152K	1.60±0.10	0.80±0.10	0.80±0.10		0.03	1kHz	1.0Vrms	±7.5%	±12.5%	±12.5%	±15%	2.0 x R.V.	Paper	4,000	10,000		
203		C1608X7R1H222K	1.60±0.10	0.80±0.10	0.80±0.10		0.03	1kHz	1.0Vrms	±7.5%	±12.5%	±12.5%	±15%	2.0 x R.V.	Paper	4,000	10,000		
204		C1608X7R1H332K	1.60±0.10	0.80±0.10	0.80±0.10		0.03	1kHz	1.0Vrms	±7.5%	±12.5%	±12.5%	±15%	2.0 x R.V.	Paper	4,000	10,000		
205		C1608X7R1H472K	1.60±0.10	0.80±0.10	0.80±0.10		0.03	1kHz	1.0Vrms	±7.5%	±12.5%	±12.5%	±15%	2.0 x R.V.	Paper	4,000	10,000		
206		C1608X7R1H682K	1.60±0.10	0.80±0.10	0.80±0.10		0.03	1kHz	1.0Vrms	±7.5%	±12.5%	±12.5%	±15%	2.0 x R.V.	Paper	4,000	10,000		
207		C1608X7R1H103K	1.60±0.10	0.80±0.10	0.80±0.10		0.03	1kHz	1.0Vrms	±7.5%	±12.5%	±12.5%	±15%	2.0 x R.V.	Paper	4,000	10,000		
208		C1608X7R1H153K	1.60±0.10	0.80±0.10	0.80±0.10		0.03	1kHz	1.0Vrms	±7.5%	±12.5%	±12.5%	±15%	2.0 x R.V.	Paper	4,000	10,000		
209		C1608X7R1H223K	1.60±0.10	0.80±0.10	0.80±0.10		0.03	1kHz	1.0Vrms	±7.5%	±12.5%	±12.5%	±15%	2.0 x R.V.	Paper	4,000	10,000		
210		C1608X7R1H333K	1.60±0.10	0.80±0.10	0.80±0.10		0.03	1kHz	1.0Vrms	±7.5%	±12.5%	±12.5%	±15%	2.0 x R.V.	Paper	4,000	10,000		
211		C1608X7R1H473K	1.60±0.10	0.80±0.10	0.80±0.10		0.03	1kHz	1.0Vrms	±7.5%	±12.5%	±12.5%	±15%	2.0 x R.V.	Paper	4,000	10,000		
212		C1608X7R1H683K	1.60±0.10	0.80±0.10	0.80±0.10		0.03	1kHz	1.0Vrms	±7.5%	±12.5%	±12.5%	±15%	2.0 x R.V.	Paper	4,000	10,000		
213		C1608X7R1H104K	1.60±0.10	0.80±0.10	0.80±0.10		0.03	1kHz	1.0Vrms	±7.5%	±12.5%	±12.5%	±15%	2.0 x R.V.	Paper	4,000	10,000		
214		C1608X7R1E104K	1.60±0.10	0.80±0.10	0.80±0.10		0.03	1kHz	1.0Vrms	±7.5%	±12.5%	±12.5%	±15%	2.0 x R.V.	Paper	4,000	10,000		
215		C1608X7R1E154K	1.60±0.10	0.80±0.10	0.80±0.10		0.03	1kHz	1.0Vrms	±7.5%	±12.5%	±12.5%	±15%	2.0 x R.V.	Paper	4,000	10,000		
216		C1608X7R1E224K	1.60±0.10	0.80±0.10	0.80±0.10		0.03	1kHz	1.0Vrms	±12.5%	±25%	±25%	±25%	R.V.	Paper	4,000	10,000		
217		C1608X7R1C334K	1.60±0.10	0.80±0.10	0.80±0.10		0.05	1kHz	0.1Vrms	±12.5%	±25%	±25%	±25%	R.V.	Paper	4,000	10,000		
218		C1608X7R1C474K	1.60±0.10	0.80±0.10	0.80±0.10		0.05	1kHz	0.1Vrms	±12.5%	±25%	±25%	±25%	R.V.	Paper	4,000	10,000		
219		C1608X7R1C684K	1.60±0.10	0.80±0.10	0.80±0.10		0.05	1kHz	0.1Vrms	±12.5%	±25%	±25%	±25%	R.V.	Paper	4,000	10,000		
220		C1608X7R1C105K	1.60±0.10	0.80±0.10	0.80±0.10		0.05	1kHz	0.1Vrms	±12.5%	±25%	±25%	±25%	R.V.	Paper	4,000	10,000		

No	Your Part No.	TDK product	Dimensions			Q (min.)	tanδ (max.)	Temp. Characteristics of Cap.		Temp cycle ΔC/C	Moisture Resistance (Steady state) ΔC/C	Moisture Resistance ΔC/C	Life		Tape packaging materials	Qty. per 1 reel	
			L (mm)	W (mm)	T (mm)			Measuring frequency	Measuring voltage				ΔC/C	Test voltage		φ178mm	φ330mm
221		C1608Y5V1H104Z	1.60±0.10	0.80±0.10	0.80±0.10		0.05	1kHz	1.0Vrms	±20%	±30%	±30%	±30%	2.0 x R.V.	Paper	4,000	10,000
222		C1608Y5V1H224Z	1.60±0.10	0.80±0.10	0.80±0.10		0.05	1kHz	1.0Vrms	±20%	±30%	±30%	±30%	2.0 x R.V.	Paper	4,000	10,000
223		C1608Y5V1H474Z	1.60±0.10	0.80±0.10	0.80±0.10		0.05	1kHz	1.0Vrms	±20%	±30%	±30%	±30%	2.0 x R.V.	Paper	4,000	10,000
224		C1608Y5V1E105Z	1.60±0.10	0.80±0.10	0.80±0.10		0.075	1kHz	1.0Vrms	±20%	±30%	±30%	±30%	2.0 x R.V.	Paper	4,000	10,000
225		C1608Y5V1C225Z	1.60±0.10	0.80±0.10	0.80±0.10		0.10	1kHz	1.0Vrms	±20%	±30%	±30%	±30%	2.0 x R.V.	Paper	4,000	10,000
226		C1608Y5V0J475Z	1.60±0.10	0.80±0.10	0.80±0.10		0.20	1kHz	0.2Vrms	±20%	±30%	±40%	±40%	2.0 x R.V.	Paper	4,000	10,000
227		C2012C0G1H392J	2.00±0.20	1.25±0.20	0.85±0.15	1,000		1kHz	0.5-5Vrms	±2.5%	±5.0%	±7.5%	±3.0%	2.0 x R.V.	Paper	4,000	10,000
228		C2012C0G1H472J	2.00±0.20	1.25±0.20	0.85±0.15	1,000		1kHz	0.5-5Vrms	±2.5%	±5.0%	±7.5%	±3.0%	2.0 x R.V.	Paper	4,000	10,000
229		C2012C0G1H562J	2.00±0.20	1.25±0.20	0.85±0.15	1,000		1kHz	0.5-5Vrms	±2.5%	±5.0%	±7.5%	±3.0%	2.0 x R.V.	Paper	4,000	10,000
230		C2012C0G1H682J	2.00±0.20	1.25±0.20	1.25±0.20	1,000		1kHz	0.5-5Vrms	±2.5%	±5.0%	±7.5%	±3.0%	2.0 x R.V.	Plastic	2,000	10,000
231		C2012C0G1H822J	2.00±0.20	1.25±0.20	1.25±0.20	1,000		1kHz	0.5-5Vrms	±2.5%	±5.0%	±7.5%	±3.0%	2.0 x R.V.	Plastic	2,000	10,000
232		C2012C0G1H103J	2.00±0.20	1.25±0.20	1.25±0.20	1,000		1kHz	0.5-5Vrms	±2.5%	±5.0%	±7.5%	±3.0%	2.0 x R.V.	Plastic	2,000	10,000
233		C2012X5R1E684K	2.00±0.20	1.25±0.20	1.25±0.20		0.05	1kHz	1.0Vrms	±7.5%	±12.5%	±12.5%	±15%	2.0 x R.V.	Plastic	2,000	10,000
234		C2012X5R1E105K	2.00±0.20	1.25±0.20	1.25±0.20		0.05	1kHz	1.0Vrms	±7.5%	±12.5%	±12.5%	±15%	2.0 x R.V.	Plastic	2,000	10,000
235		C2012X5R1E155K	2.00±0.20	1.25±0.20	1.25±0.20		0.05	1kHz	1.0Vrms	±7.5%	±12.5%	±12.5%	±15%	2.0 x R.V.	Plastic	2,000	10,000
236		C2012X5R1E225K	2.00±0.20	1.25±0.20	1.25±0.20		0.05	1kHz	1.0Vrms	±12.5%	±25%	±25%	±25%	1.5 x R.V.	Plastic	2,000	10,000
237		C2012X5R1E335K	2.00±0.20	1.25±0.20	1.25±0.20		0.075	1kHz	1.0Vrms	±7.5%	±12.5%	±12.5%	±15%	1.5 x R.V.	Plastic	2,000	10,000
238		C2012X5R1E475K	2.00±0.20	1.25±0.20	1.25±0.20		0.075	1kHz	1.0Vrms	±7.5%	±12.5%	±12.5%	±15%	1.5 x R.V.	Plastic	2,000	10,000
239		C2012X5R1C105K	2.00±0.20	1.25±0.20	1.25±0.20		0.05	1kHz	1.0Vrms	±7.5%	±12.5%	±12.5%	±15%	2.0 x R.V.	Plastic	2,000	10,000
240		C2012X5R1C155K	2.00±0.20	1.25±0.20	1.25±0.20		0.075	1kHz	1.0Vrms	±7.5%	±12.5%	±12.5%	±15%	2.0 x R.V.	Plastic	2,000	10,000
241		C2012X5R1C225K	2.00±0.20	1.25±0.20	1.25±0.20		0.075	1kHz	1.0Vrms	±7.5%	±12.5%	±12.5%	±15%	2.0 x R.V.	Plastic	2,000	10,000
242		C2012X5R1C335K	2.00±0.20	1.25±0.20	1.25±0.20		0.05	1kHz	0.1Vrms	±12.5%	±25%	±25%	±25%	R.V.	Plastic	2,000	10,000
243		C2012X5R1C475K	2.00±0.20	1.25±0.20	1.25±0.20		0.05	1kHz	0.1Vrms	±12.5%	±25%	±25%	±25%	R.V.	Plastic	2,000	10,000
244		C2012X5R1C106K	2.00±0.20	1.25±0.20	1.25±0.20		0.10	1kHz	1.0Vrms	±12.5%	±25%	±25%	±25%	1.5 x R.V.	Plastic	2,000	10,000
245		C2012X5R1A335K	2.00±0.20	1.25±0.20	1.25±0.20		0.05	1kHz	0.1Vrms	±12.5%	±25%	±25%	±25%	2.0 x R.V.	Plastic	2,000	10,000
246		C2012X5R1A475K	2.00±0.20	1.25±0.20	1.25±0.20		0.05	1kHz	0.1Vrms	±12.5%	±25%	±25%	±25%	2.0 x R.V.	Plastic	2,000	10,000
247		C2012X5R1A685K	2.00±0.20	1.25±0.20	1.25±0.20		0.10	1kHz	0.5Vrms	±15%	±25%	±25%	±25%	R.V.	Plastic	2,000	10,000
248		C2012X5R1A106K	2.00±0.20	1.25±0.20	1.25±0.20		0.10	1kHz	0.2Vrms	±7.5%	±12.5%	±12.5%	±15%	R.V.	Plastic	2,000	10,000
249		C2012X5R0J106K (T=0.85)	2.00±0.20	1.25±0.20	0.85±0.15		0.10	1kHz	0.5Vrms	±15%	±25%	±25%	±25%	R.V.	Plastic	4,000	10,000
250		C2012X5R0J106K (T=1.25)	2.00±0.20	1.25±0.20	1.25±0.20		0.10	1kHz	0.2Vrms	±7.5%	±12.5%	±12.5%	±15%	1.5 x R.V.	Plastic	2,000	10,000
251		C2012X5R0J156M	2.00±0.20	1.25±0.20	1.25±0.20		0.15	120Hz	0.5Vrms	±12.5%	±25%	±25%	±25%	R.V.	Plastic	2,000	10,000
252		C2012X5R0J226M	2.00±0.20	1.25±0.20	1.25±0.20		0.15	120Hz	0.5Vrms	±12.5%	±25%	±25%	±25%	R.V.	Plastic	2,000	10,000
253		C2012X7R1H154K	2.00±0.20	1.25±0.20	1.25±0.20		0.03	1kHz	1.0Vrms	±7.5%	±12.5%	±12.5%	±15%	2.0 x R.V.	Plastic	2,000	10,000
254		C2012X7R1H224K	2.00±0.20	1.25±0.20	1.25±0.20		0.03	1kHz	1.0Vrms	±7.5%	±12.5%	±12.5%	±15%	2.0 x R.V.	Plastic	2,000	10,000
255		C2012X7R1H334K	2.00±0.20	1.25±0.20	1.25±0.20		0.03	1kHz	1.0Vrms	±7.5%	±12.5%	±12.5%	±15%	2.0 x R.V.	Plastic	2,000	10,000
256		C2012X7R1E474K	2.00±0.20	1.25±0.20	1.25±0.20		0.03	1kHz	1.0Vrms	±7.5%	±12.5%	±12.5%	±15%	2.0 x R.V.	Plastic	2,000	10,000
257		C2012X7R1E684K	2.00±0.20	1.25±0.20	1.25±0.20		0.05	1kHz	1.0Vrms	±7.5%	±12.5%	±12.5%	±15%	1.5 x R.V.	Plastic	2,000	10,000
258		C2012X7R1E105K	2.00±0.20	1.25±0.20	1.25±0.20		0.05	1kHz	1.0Vrms	±7.5%	±12.5%	±12.5%	±15%	1.5 x R.V.	Plastic	2,000	10,000
259		C2012X7R1E155K	2.00±0.20	1.25±0.20	1.25±0.20		0.05	1kHz	1.0Vrms	±7.5%	±12.5%	±12.5%	±15%	1.5 x R.V.	Plastic	2,000	10,000
260		C2012X7R1C105K	2.00±0.20	1.25±0.20	1.25±0.20		0.05	1kHz	1.0Vrms	±7.5%	±12.5%	±12.5%	±15%	2.0 x R.V.	Plastic	2,000	10,000
261		C2012X7R1C155K	2.00±0.20	1.25±0.20	1.25±0.20		0.075	1kHz	1.0Vrms	±7.5%	±12.5%	±12.5%	±15%	1.5 x R.V.	Plastic	2,000	10,000
262		C2012X7R1C225K	2.00±0.20	1.25±0.20	1.25±0.20		0.075	1kHz	1.0Vrms	±7.5%	±12.5%	±12.5%	±15%	1.5 x R.V.	Plastic	2,000	10,000
263		C2012X7R1A335K	2.00±0.20	1.25±0.20	1.25±0.20		0.05	1kHz	0.1Vrms	±12.5%	±25%	±25%	±25%	R.V.	Plastic	2,000	10,000
264		C2012X7R1A475K	2.00±0.20	1.25±0.20	1.25±0.20		0.05	1kHz	0.1Vrms	±12.5%	±25%	±25%	±25%	R.V.	Plastic	2,000	10,000
265		C2012X7R1A106K	2.00±0.20	1.25±0.20	1.25±0.20		0.10	1kHz	0.5Vrms	±12.5%	±25%	±25%	±25%	R.V.	Plastic	2,000	10,000
266		C2012X7R0J106K	2.00±0.20	1.25±0.20	1.25±0.20		0.10	1kHz	0.5Vrms	±12.5%	±25%	±25%	±25%	1.5 x R.V.	Plastic	2,000	10,000

No	Your Part No.	TDK product	Dimensions			Q (min.)	tanδ (max.)	Temp. Characteristics of Cap.		Temp cycle ΔC/C	Moisture Resistance (Steady state)		Moisture Resistance ΔC/C	Life		Tape packaging materials	Qty. per 1 reel	
			L (mm)	W (mm)	T (mm)			Measuring frequency	Measuring voltage		ΔC/C	ΔC/C		ΔC/C	ΔC/C		Test voltage	φ178mm
267		C2012Y5V1H105Z	2.00±0.20	1.25±0.20	0.85±0.15		0.05	1kHz	1.0Vrms	±20%	±30%	±30%	±30%	2.0 x R.V.	Paper	4,000	10,000	
268		C2012Y5V1H225Z	2.00±0.20	1.25±0.20	1.25±0.20		0.05	1kHz	1.0Vrms	±20%	±30%	±30%	±30%	2.0 x R.V.	Plastic	2,000	10,000	
269		C2012Y5V1E475Z	2.00±0.20	1.25±0.20	1.25±0.20		0.075	1kHz	1.0Vrms	±20%	±30%	±30%	±30%	2.0 x R.V.	Plastic	2,000	10,000	
270		C2012Y5V1C106Z	2.00±0.20	1.25±0.20	1.25±0.20		0.10	1kHz	1.0Vrms	±20%	±30%	±30%	±30%	2.0 x R.V.	Plastic	2,000	10,000	
271		C2012Y5V0J226Z	2.00±0.20	1.25±0.20	1.25±0.20		0.20	120Hz	0.5Vrms	±20%	±30%	±40%	±40%	2.0 x R.V.	Plastic	2,000	10,000	
272		C3216C0G1H153K	3.20±0.20	1.60±0.20	1.15±0.15	1,000		1kHz	0.5-5Vrms	±2.5%	±5.0%	±7.5%	±3.0%	2.0 x R.V.	Plastic	2,000	10,000	
273		C3216C0G1H223K	3.20±0.20	1.60±0.20	1.15±0.15	1,000		1kHz	0.5-5Vrms	±2.5%	±5.0%	±7.5%	±3.0%	2.0 x R.V.	Plastic	2,000	10,000	
274		C3216C0G1H333K	3.20±0.20	1.60±0.20	1.60±0.20	1,000		1kHz	0.5-5Vrms	±2.5%	±5.0%	±7.5%	±3.0%	2.0 x R.V.	Plastic	2,000	8,000	
275		C3216X5R1H105K	3.20±0.20	1.60±0.20	1.60±0.20		0.05	1kHz	1.0Vrms	±7.5%	±12.5%	±12.5%	±15%	2.0 x R.V.	Plastic	2,000	8,000	
276		C3216X5R1E155K	3.20±0.20	1.60±0.20	1.60±0.20		0.03	1kHz	1.0Vrms	±7.5%	±12.5%	±12.5%	±15%	2.0 x R.V.	Plastic	2,000	8,000	
277		C3216X5R1E225K	3.20±0.20	1.60±0.20	1.60±0.20		0.03	1kHz	1.0Vrms	±7.5%	±12.5%	±12.5%	±15%	2.0 x R.V.	Plastic	2,000	8,000	
278		C3216X5R1E335K	3.20±0.20	1.60±0.20	1.60±0.20		0.03	1kHz	1.0Vrms	±12.5%	±25%	±25%	±25%	2.0 x R.V.	Plastic	2,000	8,000	
279		C3216X5R1E475K	3.20±0.20	1.60±0.20	1.60±0.20		0.03	1kHz	1.0Vrms	±12.5%	±25%	±25%	±25%	2.0 x R.V.	Plastic	2,000	8,000	
280		C3216X5R1C685K	3.20±0.20	1.60±0.20	1.60±0.20		0.05	1kHz	0.1Vrms	±12.5%	±25%	±25%	±25%	2.0 x R.V.	Plastic	2,000	8,000	
281		C3216X5R1C106K	3.20±0.20	1.60±0.20	1.60±0.20		0.05	1kHz	0.1Vrms	±12.5%	±25%	±25%	±25%	2.0 x R.V.	Plastic	2,000	8,000	
282		C3216X5R1A106K (T=0.85)	3.20±0.20	1.60±0.20	0.85±0.15		0.075	1kHz	0.2Vrms	±7.5%	±12.5%	±12.5%	±15%	R.V.	Plastic	4,000	10,000	
283		C3216X5R1A106K (T=1.60)	3.20+0.30/-0.10	1.60+0.30/-0.10	1.60+0.30/-0.10		0.075	1kHz	0.2Vrms	±7.5%	±12.5%	±12.5%	±15%	2.0 x R.V.	Plastic	2,000	8,000	
284		C3216X5R0J106K	3.20±0.20	1.60±0.20	0.85±0.15		0.075	1kHz	0.2Vrms	±7.5%	±12.5%	±12.5%	±15%	2.0 x R.V.	Plastic	4,000	10,000	
285		C3216X5R0J156M	3.20±0.20	1.60±0.20	1.60±0.20		0.075	120Hz	0.5Vrms	±7.5%	±12.5%	±12.5%	±15%	2.0 x R.V.	Plastic	2,000	8,000	
286		C3216X5R0J226M (T=0.85)	3.20±0.20	1.60±0.20	0.85±0.15		0.15	120Hz	0.5Vrms	±12.5%	±25%	±25%	±25%	R.V.	Plastic	4,000	10,000	
287		C3216X5R0J226M (T=1.60)	3.20+0.30/-0.10	1.60+0.30/-0.10	1.60+0.30/-0.10		0.075	120Hz	0.5Vrms	±7.5%	±12.5%	±12.5%	±15%	2.0 x R.V.	Plastic	2,000	8,000	
288		C3216X5R0J336M	3.20±0.20	1.60±0.20	1.30±0.20		0.15	120Hz	0.5Vrms	±12.5%	±25%	±25%	±25%	R.V.	Plastic	2,000	10,000	
289		C3216X5R0J476M	3.20±0.20	1.60±0.20	1.60±0.20		0.15	120Hz	0.5Vrms	±12.5%	±25%	±25%	±25%	R.V.	Plastic	2,000	8,000	
290		C3216X7R1H474K	3.20±0.20	1.60±0.20	1.60±0.20		0.03	1kHz	1.0Vrms	±7.5%	±12.5%	±12.5%	±15%	2.0 x R.V.	Plastic	2,000	8,000	
291		C3216X7R1H684K	3.20±0.20	1.60±0.20	1.60±0.20		0.03	1kHz	1.0Vrms	±7.5%	±12.5%	±12.5%	±15%	2.0 x R.V.	Plastic	2,000	8,000	
292		C3216X7R1H105K	3.20±0.20	1.60±0.20	1.60±0.20		0.05	1kHz	1.0Vrms	±7.5%	±12.5%	±12.5%	±15%	1.5 x R.V.	Plastic	2,000	8,000	
293		C3216X7R1E155K	3.20±0.20	1.60±0.20	1.60±0.20		0.03	1kHz	1.0Vrms	±7.5%	±12.5%	±12.5%	±15%	2.0 x R.V.	Plastic	2,000	8,000	
294		C3216X7R1E225K	3.20±0.20	1.60±0.20	1.60±0.20		0.03	1kHz	1.0Vrms	±7.5%	±12.5%	±12.5%	±15%	2.0 x R.V.	Plastic	2,000	8,000	
295		C3216X7R1E335K	3.20±0.20	1.60±0.20	1.60±0.20		0.03	1kHz	1.0Vrms	±12.5%	±25%	±25%	±25%	R.V.	Plastic	2,000	8,000	
296		C3216X7R1E475K	3.20±0.20	1.60±0.20	1.60±0.20		0.03	1kHz	1.0Vrms	±12.5%	±25%	±25%	±25%	R.V.	Plastic	2,000	8,000	
297		C3216X7R1C475K	3.20±0.20	1.60±0.20	1.60±0.20		0.075	1kHz	1.0Vrms	±7.5%	±12.5%	±12.5%	±15%	1.5 x R.V.	Plastic	2,000	8,000	
298		C3216X7R1C685K	3.20±0.20	1.60±0.20	1.60±0.20		0.05	1kHz	0.1Vrms	±12.5%	±25%	±25%	±25%	R.V.	Plastic	2,000	8,000	
299		C3216X7R1C106K	3.20±0.20	1.60±0.20	1.60±0.20		0.05	1kHz	0.1Vrms	±12.5%	±25%	±25%	±25%	R.V.	Plastic	2,000	8,000	
300		C3216X7R1A106K	3.20+0.30/-0.10	1.60+0.30/-0.10	1.60+0.30/-0.10		0.075	1kHz	0.2Vrms	±7.5%	±12.5%	±12.5%	±15%	R.V.	Plastic	2,000	8,000	
301		C3216X7R0J106K	3.20±0.20	1.60±0.20	1.60±0.20		0.05	1kHz	0.2Vrms	±7.5%	±12.5%	±12.5%	±15%	R.V.	Plastic	2,000	8,000	

No	Your Part No.	TDK product	Dimensions			Q (min.)	tanδ (max.)	Temp. Characteristics of Cap.		Temp cycle ΔC/C	Moisture Resistance (Steady state) ΔC/C	Moisture Resistance ΔC/C	Life		Tape packaging materials	Qty. per 1 reel	
			L (mm)	W (mm)	T (mm)			Measuring frequency	Measuring voltage				ΔC/C	Test voltage		φ178mm	φ330mm
302		C3216Y5V1H475Z	3.20±0.20	1.60±0.20	1.60±0.20		0.05	1kHz	1.0Vrms	±20%	±30%	±30%	±30%	2.0 x R.V.	Plastic	2,000	8,000
303		C3216Y5V1E106Z	3.20±0.20	1.60±0.20	1.60±0.20		0.075	1kHz	1.0Vrms	±20%	±30%	±30%	±30%	2.0 x R.V.	Plastic	2,000	8,000
304		C3216Y5V1C226Z	3.20±0.20	1.60±0.20	1.60±0.20		0.10	120Hz	0.5Vrms	±20%	±30%	±30%	±30%	2.0 x R.V.	Plastic	2,000	8,000
305		C3216Y5V0J476Z	3.20±0.30/-0.10	1.60±0.30/-0.10	1.60±0.30/-0.10		0.20	120Hz	0.5Vrms	±20%	±30%	±40%	±40%	2.0 x R.V.	Plastic	2,000	8,000
306		C3225C0G1H473K	3.20±0.40	2.50±0.30	2.00±0.20	1,000		1kHz	0.5-5Vrms	±2.5%	±5.0%	±7.5%	±3.0%	2.0 x R.V.	Plastic	1,000	5,000
307		C3225C0G1H683K	3.20±0.40	2.50±0.30	2.00±0.20	1,000		1kHz	0.5-5Vrms	±2.5%	±5.0%	±7.5%	±3.0%	2.0 x R.V.	Plastic	1,000	5,000
308		C3225C0G1H104K	3.20±0.40	2.50±0.30	2.50±0.30	1,000		1kHz	0.5-5Vrms	±2.5%	±5.0%	±7.5%	±3.0%	2.0 x R.V.	Plastic	1,000	5,000
309		C3225X5R1H225K	3.20±0.40	2.50±0.30	2.00±0.20		0.05	1kHz	1.0Vrms	±7.5%	±12.5%	±12.5%	±15%	2.0 x R.V.	Plastic	1,000	5,000
310		C3225X5R1H335K	3.20±0.40	2.50±0.30	2.50±0.30		0.05	1kHz	1.0Vrms	±7.5%	±12.5%	±12.5%	±15%	2.0 x R.V.	Plastic	1,000	5,000
311		C3225X5R1E475K	3.20±0.40	2.50±0.30	2.00±0.20		0.03	1kHz	1.0Vrms	±7.5%	±12.5%	±12.5%	±15%	2.0 x R.V.	Plastic	1,000	5,000
312		C3225X5R1E685K	3.20±0.40	2.50±0.30	2.50±0.30		0.05	1kHz	1.0Vrms	±7.5%	±12.5%	±12.5%	±15%	2.0 x R.V.	Plastic	1,000	5,000
313		C3225X5R1E106K	3.20±0.40	2.50±0.30	2.50±0.30		0.03	1kHz	1.0Vrms	±12.5%	±25%	±25%	±25%	2.0 x R.V.	Plastic	1,000	5,000
314		C3225X5R1C106K	3.20±0.40	2.50±0.30	2.00±0.20		0.075	1kHz	1.0Vrms	±7.5%	±12.5%	±12.5%	±15%	2.0 x R.V.	Plastic	1,000	5,000
315		C3225X5R1C156M	3.20±0.40	2.50±0.30	2.50±0.30		0.075	120Hz	0.5Vrms	±7.5%	±12.5%	±12.5%	±15%	2.0 x R.V.	Plastic	1,000	5,000
316		C3225X5R1C226M	3.20±0.40	2.50±0.30	2.50±0.30		0.05	120Hz	0.5Vrms	±12.5%	±25%	±25%	±25%	2.0 x R.V.	Plastic	1,000	5,000
317		C3225X5R1A226M	3.20±0.40	2.50±0.30	2.30±0.20		0.075	120Hz	0.5Vrms	±7.5%	±12.5%	±12.5%	±15%	2.0 x R.V.	Plastic	1,000	5,000
318		C3225X5R0J226M	3.20±0.40	2.50±0.30	2.00±0.20		0.05	120Hz	0.5Vrms	±7.5%	±12.5%	±12.5%	±15%	2.0 x R.V.	Plastic	1,000	5,000
319		C3225X5R0J336M	3.20±0.40	2.50±0.30	2.00±0.20		0.075	120Hz	0.5Vrms	±7.5%	±12.5%	±12.5%	±15%	2.0 x R.V.	Plastic	1,000	5,000
320		C3225X5R0J476M	3.20±0.40	2.50±0.30	2.50±0.30		0.075	120Hz	0.5Vrms	±7.5%	±12.5%	±12.5%	±15%	2.0 x R.V.	Plastic	1,000	5,000
321		C3225X5R0J686M	3.20±0.40	2.50±0.30	2.00±0.20		0.15	120Hz	0.5Vrms	±12.5%	±25%	±25%	±25%	R.V.	Plastic	1,000	5,000
322		C3225X5R0J107M	3.20±0.40	2.50±0.30	2.50±0.30		0.15	120Hz	0.5Vrms	±12.5%	±25%	±25%	±25%	R.V.	Plastic	1,000	5,000
323		C3225X7R1H105K	3.20±0.40	2.50±0.30	1.60±0.20		0.03	1kHz	1.0Vrms	±7.5%	±12.5%	±12.5%	±15%	2.0 x R.V.	Plastic	2,000	8,000
324		C3225X7R1H155K	3.20±0.40	2.50±0.30	2.00±0.20		0.03	1kHz	1.0Vrms	±7.5%	±12.5%	±12.5%	±15%	2.0 x R.V.	Plastic	1,000	5,000
325		C3225X7R1H225K	3.20±0.40	2.50±0.30	2.00±0.20		0.05	1kHz	1.0Vrms	±7.5%	±12.5%	±12.5%	±15%	1.5 x R.V.	Plastic	1,000	5,000
326		C3225X7R1H335K	3.20±0.40	2.50±0.30	2.50±0.30		0.05	1kHz	1.0Vrms	±7.5%	±12.5%	±12.5%	±15%	1.5 x R.V.	Plastic	1,000	5,000
327		C3225X7R1E335K	3.20±0.40	2.50±0.30	1.60±0.20		0.03	1kHz	1.0Vrms	±7.5%	±12.5%	±12.5%	±15%	2.0 x R.V.	Plastic	2,000	8,000
328		C3225X7R1E475K	3.20±0.40	2.50±0.30	2.00±0.20		0.03	1kHz	1.0Vrms	±7.5%	±12.5%	±12.5%	±15%	2.0 x R.V.	Plastic	1,000	5,000
329		C3225X7R1E685K	3.20±0.40	2.50±0.30	2.50±0.30		0.05	1kHz	1.0Vrms	±7.5%	±12.5%	±12.5%	±15%	1.5 x R.V.	Plastic	1,000	5,000
330		C3225X7R1E106K	3.20±0.40	2.50±0.30	2.50±0.30		0.03	1kHz	1.0Vrms	±12.5%	±25%	±25%	±25%	R.V.	Plastic	1,000	5,000
331		C3225X7R1C106K	3.20±0.40	2.50±0.30	2.00±0.20		0.075	1kHz	1.0Vrms	±7.5%	±12.5%	±12.5%	±15%	1.5 x R.V.	Plastic	1,000	5,000
332		C3225X7R1C156M	3.20±0.40	2.50±0.30	2.50±0.30		0.075	120Hz	0.5Vrms	±7.5%	±12.5%	±12.5%	±15%	1.5 x R.V.	Plastic	1,000	5,000
333		C3225X7R1C226M	3.20±0.40	2.50±0.30	2.50±0.30		0.05	120Hz	0.5Vrms	±12.5%	±25%	±25%	±25%	R.V.	Plastic	1,000	5,000
334		C3225X7R1A226M	3.20±0.40	2.50±0.30	2.30±0.20		0.075	120Hz	0.5Vrms	±7.5%	±12.5%	±12.5%	±15%	R.V.	Plastic	1,000	5,000
335		C3225Y5V1H106Z	3.20±0.40	2.50±0.30	1.60±0.20		0.05	1kHz	1.0Vrms	±20%	±30%	±30%	±30%	2.0 x R.V.	Plastic	2,000	8,000
336		C3225Y5V1E226Z	3.20±0.40	2.50±0.30	2.00±0.20		0.075	120Hz	0.5Vrms	±20%	±30%	±30%	±30%	2.0 x R.V.	Plastic	1,000	5,000
337		C3225Y5V1C476Z	3.20±0.40	2.50±0.30	2.30±0.20		0.10	120Hz	0.5Vrms	±20%	±30%	±30%	±30%	2.0 x R.V.	Plastic	1,000	5,000
338		C3225Y5V1A476Z	3.20±0.40	2.50±0.30	2.00±0.20		0.125	120Hz	0.5Vrms	±20%	±30%	±30%	±30%	2.0 x R.V.	Plastic	1,000	5,000
339		C3225Y5V0J107Z	3.20±0.40	2.50±0.30	2.50±0.30		0.20	120Hz	0.5Vrms	±20%	±30%	±40%	±40%	2.0 x R.V.	Plastic	1,000	5,000

No	Your Part No.	TDK product	Dimensions			Q (min.)	tanδ (max.)	Temp. Characteristics of Cap.		Temp cycle ΔC/C	Moisture Resistance (Steady state)		Moisture Resistance ΔC/C	Life		Tape packaging materials	Qty. per 1 reel	
			L (mm)	W (mm)	T (mm)			Measuring frequency	Measuring voltage		ΔC/C	ΔC/C		ΔC/C	ΔC/C		Test voltage	φ178mm
340		C4532C0G1H154K	4.50±0.40	3.20±0.40	2.50±0.30	1,000		1kHz	0.5-5Vrms	±2.5%	±5.0%	±7.5%	±3.0%	2.0 x R.V.	Plastic	500	3,000	
341		C4532C0G1H224K	4.50±0.40	3.20±0.40	3.20±0.40	1,000		1kHz	0.5-5Vrms	±2.5%	±5.0%	±7.5%	±3.0%	2.0 x R.V.	Plastic	500	2,000	
342		C4532X5R1H475K	4.50±0.40	3.20±0.40	2.00±0.20		0.05	1kHz	1.0Vrms	±7.5%	±12.5%	±12.5%	±15%	2.0 x R.V.	Plastic	1,000	3,000	
343		C4532X5R1H685K	4.50±0.40	3.20±0.40	2.50±0.30		0.05	1kHz	1.0Vrms	±7.5%	±12.5%	±12.5%	±15%	2.0 x R.V.	Plastic	500	3,000	
344		C4532X5R1E106K	4.50±0.40	3.20±0.40	2.50±0.30		0.03	1kHz	1.0Vrms	±7.5%	±12.5%	±12.5%	±15%	2.0 x R.V.	Plastic	500	3,000	
345		C4532X5R1E156M	4.50±0.40	3.20±0.40	2.80±0.30		0.05	120Hz	0.5Vrms	±12.5%	±25%	±25%	±25%	2.0 x R.V.	Plastic	500	2,000	
346		C4532X5R1E226M	4.50±0.40	3.20±0.40	2.50±0.30		0.03	120Hz	0.5Vrms	±12.5%	±25%	±25%	±25%	2.0 x R.V.	Plastic	500	3,000	
347		C4532X5R1C336M	4.50±0.40	3.20±0.40	2.50±0.30		0.05	120Hz	0.5Vrms	±12.5%	±25%	±25%	±25%	2.0 x R.V.	Plastic	500	3,000	
348		C4532X5R1A476M	4.50±0.40	3.20±0.40	2.80±0.30		0.075	120Hz	0.5Vrms	±7.5%	±12.5%	±12.5%	±15%	2.0 x R.V.	Plastic	500	2,000	
349		C4532X5R0J107M	4.50±0.40	3.20±0.40	2.80±0.30		0.075	120Hz	0.5Vrms	±7.5%	±12.5%	±12.5%	±15%	2.0 x R.V.	Plastic	500	2,000	
350		C4532X7R1H225K	4.50±0.40	3.20±0.40	1.60±0.20		0.03	1kHz	1.0Vrms	±7.5%	±12.5%	±12.5%	±15%	2.0 x R.V.	Plastic	1,000	3,000	
351		C4532X7R1H335K	4.50±0.40	3.20±0.40	2.00±0.20		0.03	1kHz	1.0Vrms	±7.5%	±12.5%	±12.5%	±15%	2.0 x R.V.	Plastic	1,000	3,000	
352		C4532X7R1H475K	4.50±0.40	3.20±0.40	2.00±0.20		0.05	1kHz	1.0Vrms	±7.5%	±12.5%	±12.5%	±15%	1.5 x R.V.	Plastic	1,000	3,000	
353		C4532X7R1H685K	4.50±0.40	3.20±0.40	2.50±0.30		0.05	1kHz	1.0Vrms	±7.5%	±12.5%	±12.5%	±15%	1.5 x R.V.	Plastic	500	3,000	
354		C4532X7R1E106K	4.50±0.40	3.20±0.40	2.50±0.30		0.03	1kHz	1.0Vrms	±7.5%	±12.5%	±12.5%	±15%	2.0 x R.V.	Plastic	500	3,000	
355		C4532X7R1E156M	4.50±0.40	3.20±0.40	2.80±0.30		0.05	120Hz	0.5Vrms	±12.5%	±25%	±25%	±25%	1.5 x R.V.	Plastic	500	2,000	
356		C4532X7R1E226M	4.50±0.40	3.20±0.40	2.50±0.30		0.03	120Hz	0.5Vrms	±12.5%	±25%	±25%	±25%	R.V.	Plastic	500	3,000	
357		C4532X7R1C226M	4.50±0.40	3.20±0.40	2.30±0.20		0.075	120Hz	0.5Vrms	±7.5%	±12.5%	±12.5%	±15%	1.5 x R.V.	Plastic	500	3,000	
358		C4532X7R1C336M	4.50±0.40	3.20±0.40	2.50±0.30		0.05	120Hz	0.5Vrms	±12.5%	±25%	±25%	±25%	R.V.	Plastic	500	3,000	
359		C4532Y5V1A107Z	4.50±0.40	3.20±0.40	2.50±0.30		0.125	120Hz	0.5Vrms	±20%	±30%	±30%	±30%	2.0 x R.V.	Plastic	500	3,000	
360		C5750X5R1H106K	5.70±0.40	5.00±0.40	2.30±0.20		0.05	1kHz	1.0Vrms	±7.5%	±12.5%	±12.5%	±15%	2.0 x R.V.	Plastic	500	3,000	
361		C5750X5R1E156M	5.70±0.40	5.00±0.40	2.30±0.20		0.03	120Hz	0.5Vrms	±7.5%	±12.5%	±12.5%	±15%	2.0 x R.V.	Plastic	500	3,000	
362		C5750X5R1E226M	5.70±0.40	5.00±0.40	2.30±0.20		0.05	120Hz	0.5Vrms	±7.5%	±12.5%	±12.5%	±15%	2.0 x R.V.	Plastic	500	3,000	
363		C5750X5R1C336M	5.70±0.40	5.00±0.40	2.00±0.20		0.075	120Hz	0.5Vrms	±7.5%	±12.5%	±12.5%	±15%	2.0 x R.V.	Plastic	500	3,000	
364		C5750X5R1C476M	5.70±0.40	5.00±0.40	2.30±0.20		0.075	120Hz	0.5Vrms	±7.5%	±12.5%	±12.5%	±15%	2.0 x R.V.	Plastic	500	3,000	
365		C5750X5R1A686M	5.70±0.40	5.00±0.40	2.30±0.20		0.075	120Hz	0.5Vrms	±7.5%	±12.5%	±12.5%	±15%	2.0 x R.V.	Plastic	500	3,000	
366		C5750X7R1H475K	5.70±0.40	5.00±0.40	2.00±0.20		0.03	1kHz	1.0Vrms	±7.5%	±12.5%	±12.5%	±15%	2.0 x R.V.	Plastic	500	3,000	
367		C5750X7R1H685K	5.70±0.40	5.00±0.40	2.50±0.30		0.03	1kHz	1.0Vrms	±7.5%	±12.5%	±12.5%	±15%	2.0 x R.V.	Plastic	500	3,000	
368		C5750X7R1H106K	5.70±0.40	5.00±0.40	2.30±0.20		0.05	1kHz	1.0Vrms	±7.5%	±12.5%	±12.5%	±15%	1.5 x R.V.	Plastic	500	3,000	
369		C5750X7R1E156M	5.70±0.40	5.00±0.40	2.30±0.20		0.03	120Hz	0.5Vrms	±7.5%	±12.5%	±12.5%	±15%	2.0 x R.V.	Plastic	500	3,000	
370		C5750X7R1E226M	5.70±0.40	5.00±0.40	2.50±0.30		0.03	120Hz	0.5Vrms	±7.5%	±12.5%	±12.5%	±15%	2.0 x R.V.	Plastic	500	3,000	
371		C5750X7R1C336M	5.70±0.40	5.00±0.40	2.00±0.20		0.075	120Hz	0.5Vrms	±7.5%	±12.5%	±12.5%	±15%	1.5 x R.V.	Plastic	500	3,000	
372		C5750X7R1C476M	5.70±0.40	5.00±0.40	2.30±0.20		0.075	120Hz	0.5Vrms	±7.5%	±12.5%	±12.5%	±15%	1.5 x R.V.	Plastic	500	3,000	
373		C5750Y5V1H226Z	5.70±0.40	5.00±0.40	2.00±0.20		0.05	120Hz	0.5Vrms	±20%	±30%	±30%	±30%	2.0 x R.V.	Plastic	500	3,000	
374		C5750Y5V1E476Z	5.70±0.40	5.00±0.40	2.00±0.20		0.075	120Hz	0.5Vrms	±20%	±30%	±30%	±30%	2.0 x R.V.	Plastic	500	3,000	
375		C5750Y5V1C107Z	5.70±0.40	5.00±0.40	2.50±0.30		0.10	120Hz	0.5Vrms	±20%	±30%	±30%	±30%	2.0 x R.V.	Plastic	500	3,000	
376		C1608C0G2A101J	1.60±0.10	0.80±0.10	0.80±0.10	1,000		1MHz	0.5-5Vrms	±2.5%	±5.0%	±7.5%	±3.0%	2.0 x R.V.	Paper	4,000	10,000	
377		C1608C0G2A121J	1.60±0.10	0.80±0.10	0.80±0.10	1,000		1MHz	0.5-5Vrms	±2.5%	±5.0%	±7.5%	±3.0%	2.0 x R.V.	Paper	4,000	10,000	
378		C1608C0G2A151J	1.60±0.10	0.80±0.10	0.80±0.10	1,000		1MHz	0.5-5Vrms	±2.5%	±5.0%	±7.5%	±3.0%	2.0 x R.V.	Paper	4,000	10,000	
379		C1608C0G2A181J	1.60±0.10	0.80±0.10	0.80±0.10	1,000		1MHz	0.5-5Vrms	±2.5%	±5.0%	±7.5%	±3.0%	2.0 x R.V.	Paper	4,000	10,000	
380		C1608C0G2A221J	1.60±0.10	0.80±0.10	0.80±0.10	1,000		1MHz	0.5-5Vrms	±2.5%	±5.0%	±7.5%	±3.0%	2.0 x R.V.	Paper	4,000	10,000	
381		C1608C0G2A271J	1.60±0.10	0.80±0.10	0.80±0.10	1,000		1MHz	0.5-5Vrms	±2.5%	±5.0%	±7.5%	±3.0%	2.0 x R.V.	Paper	4,000	10,000	
382		C1608C0G2A331J	1.60±0.10	0.80±0.10	0.80±0.10	1,000		1MHz	0.5-5Vrms	±2.5%	±5.0%	±7.5%	±3.0%	2.0 x R.V.	Paper	4,000	10,000	
383		C1608C0G2A391J	1.60±0.10	0.80±0.10	0.80±0.10	1,000		1MHz	0.5-5Vrms	±2.5%	±5.0%	±7.5%	±3.0%	2.0 x R.V.	Paper	4,000	10,000	
384		C1608C0G2A471J	1.60±0.10	0.80±0.10	0.80±0.10	1,000		1MHz	0.5-5Vrms	±2.5%	±5.0%	±7.5%	±3.0%	2.0 x R.V.	Paper	4,000	10,000	
385		C1608C0G2A561J	1.60±0.10	0.80±0.10	0.80±0.10	1,000		1MHz	0.5-5Vrms	±2.5%	±5.0%	±7.5%	±3.0%	2.0 x R.V.	Paper	4,000	10,000	
386		C1608C0G2A681J	1.60±0.10	0.80±0.10	0.80±0.10	1,000		1MHz	0.5-5Vrms	±2.5%	±5.0%	±7.5%	±3.0%	2.0 x R.V.	Paper	4,000	10,000	
387		C1608C0G2A821J	1.60±0.10	0.80±0.10	0.80±0.10	1,000		1MHz	0.5-5Vrms	±2.5%	±5.0%	±7.5%	±3.0%	2.0 x R.V.	Paper	4,000	10,000	
388		C1608C0G2A102J	1.60±0.10	0.80±0.10	0.80±0.10	1,000		1MHz	0.5-5Vrms	±2.5%	±5.0%	±7.5%	±3.0%	2.0 x R.V.	Paper	4,000	10,000	
389		C1608C0G2A122J	1.60±0.10	0.80±0.10	0.80±0.10	1,000		1kHz	0.5-5Vrms	±2.5%	±5.0%	±7.5%	±3.0%	2.0 x R.V.	Paper	4,000	10,000	

No	Your Part No.	TDK product	Dimensions			Q (min.)	tanδ (max.)	Temp. Characteristics of Cap.		Temp cycle ΔC/C	Moisture Resistance (Steady state)		Moisture Resistance		Life		Tape packaging materials	Qty. per 1 reel	
			L (mm)	W (mm)	T (mm)			Measuring frequency	Measuring voltage		ΔC/C	ΔC/C	ΔC/C	ΔC/C	Test voltage	φ178mm		φ330mm	
390		C1608C0G2E101J	1.60±0.10	0.80±0.10	0.80±0.10	1,000		1MHz	0.5-5Vrms	±2.5%	±5.0%	±7.5%	±3.0%	1.5 x R.V.	Paper	4,000	10,000		
391		C1608C0G2E121J	1.60±0.10	0.80±0.10	0.80±0.10	1,000		1MHz	0.5-5Vrms	±2.5%	±5.0%	±7.5%	±3.0%	1.5 x R.V.	Paper	4,000	10,000		
392		C1608C0G2E151J	1.60±0.10	0.80±0.10	0.80±0.10	1,000		1MHz	0.5-5Vrms	±2.5%	±5.0%	±7.5%	±3.0%	1.5 x R.V.	Paper	4,000	10,000		
393		C1608C0G2E181J	1.60±0.10	0.80±0.10	0.80±0.10	1,000		1MHz	0.5-5Vrms	±2.5%	±5.0%	±7.5%	±3.0%	1.5 x R.V.	Paper	4,000	10,000		
394		C1608C0G2E221J	1.60±0.10	0.80±0.10	0.80±0.10	1,000		1MHz	0.5-5Vrms	±2.5%	±5.0%	±7.5%	±3.0%	1.5 x R.V.	Paper	4,000	10,000		
395		C1608C0G2E271J	1.60±0.10	0.80±0.10	0.80±0.10	1,000		1MHz	0.5-5Vrms	±2.5%	±5.0%	±7.5%	±3.0%	1.5 x R.V.	Paper	4,000	10,000		
396		C1608C0G2E331J	1.60±0.10	0.80±0.10	0.80±0.10	1,000		1MHz	0.5-5Vrms	±2.5%	±5.0%	±7.5%	±3.0%	1.5 x R.V.	Paper	4,000	10,000		
397		C1608C0G2E391J	1.60±0.10	0.80±0.10	0.80±0.10	1,000		1MHz	0.5-5Vrms	±2.5%	±5.0%	±7.5%	±3.0%	1.5 x R.V.	Paper	4,000	10,000		
398		C1608C0G2E471J	1.60±0.10	0.80±0.10	0.80±0.10	1,000		1MHz	0.5-5Vrms	±2.5%	±5.0%	±7.5%	±3.0%	1.5 x R.V.	Paper	4,000	10,000		
399		C1608C0G2E561J	1.60±0.10	0.80±0.10	0.80±0.10	1,000		1MHz	0.5-5Vrms	±2.5%	±5.0%	±7.5%	±3.0%	1.5 x R.V.	Paper	4,000	10,000		
400		C1608C0G2E681J	1.60±0.10	0.80±0.10	0.80±0.10	1,000		1MHz	0.5-5Vrms	±2.5%	±5.0%	±7.5%	±3.0%	1.5 x R.V.	Paper	4,000	10,000		
401		C2012C0G2A152J	2.00±0.20	1.25±0.20	0.60±0.15	1,000		1kHz	0.5-5Vrms	±2.5%	±5.0%	±7.5%	±3.0%	2.0 x R.V.	Paper	4,000	10,000		
402		C2012C0G2A182J	2.00±0.20	1.25±0.20	0.85±0.15	1,000		1kHz	0.5-5Vrms	±2.5%	±5.0%	±7.5%	±3.0%	2.0 x R.V.	Paper	4,000	10,000		
403		C2012C0G2A222J	2.00±0.20	1.25±0.20	0.85±0.15	1,000		1kHz	0.5-5Vrms	±2.5%	±5.0%	±7.5%	±3.0%	2.0 x R.V.	Paper	4,000	10,000		
404		C2012C0G2A272J	2.00±0.20	1.25±0.20	1.25±0.20	1,000		1kHz	0.5-5Vrms	±2.5%	±5.0%	±7.5%	±3.0%	2.0 x R.V.	Plastic	2,000	10,000		
405		C2012C0G2A332J	2.00±0.20	1.25±0.20	1.25±0.20	1,000		1kHz	0.5-5Vrms	±2.5%	±5.0%	±7.5%	±3.0%	2.0 x R.V.	Plastic	2,000	10,000		
406		C2012C0G2A392J	2.00±0.20	1.25±0.20	1.25±0.20	1,000		1kHz	0.5-5Vrms	±2.5%	±5.0%	±7.5%	±3.0%	2.0 x R.V.	Plastic	2,000	10,000		
407		C2012C0G2A472J	2.00±0.20	1.25±0.20	1.25±0.20	1,000		1kHz	0.5-5Vrms	±2.5%	±5.0%	±7.5%	±3.0%	2.0 x R.V.	Plastic	2,000	10,000		
408		C2012C0G2E821J	2.00±0.20	1.25±0.20	0.60±0.15	1,000		1MHz	0.5-5Vrms	±2.5%	±5.0%	±7.5%	±3.0%	1.5 x R.V.	Paper	4,000	10,000		
409		C2012C0G2E102J	2.00±0.20	1.25±0.20	0.85±0.15	1,000		1MHz	0.5-5Vrms	±2.5%	±5.0%	±7.5%	±3.0%	1.5 x R.V.	Paper	4,000	10,000		
410		C2012C0G2E122J	2.00±0.20	1.25±0.20	0.85±0.15	1,000		1kHz	0.5-5Vrms	±2.5%	±5.0%	±7.5%	±3.0%	1.5 x R.V.	Paper	4,000	10,000		
411		C2012C0G2E152J	2.00±0.20	1.25±0.20	0.85±0.15	1,000		1kHz	0.5-5Vrms	±2.5%	±5.0%	±7.5%	±3.0%	1.5 x R.V.	Paper	4,000	10,000		
412		C2012C0G2E182J	2.00±0.20	1.25±0.20	1.25±0.20	1,000		1kHz	0.5-5Vrms	±2.5%	±5.0%	±7.5%	±3.0%	1.5 x R.V.	Plastic	2,000	10,000		
413		C2012C0G2E222J	2.00±0.20	1.25±0.20	1.25±0.20	1,000		1kHz	0.5-5Vrms	±2.5%	±5.0%	±7.5%	±3.0%	1.5 x R.V.	Plastic	2,000	10,000		
414		C2012C0G2E272J	2.00±0.20	1.25±0.20	1.25±0.20	1,000		1kHz	0.5-5Vrms	±2.5%	±5.0%	±7.5%	±3.0%	1.5 x R.V.	Plastic	2,000	10,000		
415		C3216C0G2A562J	3.20±0.20	1.60±0.20	0.85±0.15	1,000		1kHz	0.5-5Vrms	±2.5%	±5.0%	±7.5%	±3.0%	2.0 x R.V.	Paper	4,000	10,000		
416		C3216C0G2A682J	3.20±0.20	1.60±0.20	1.15±0.15	1,000		1kHz	0.5-5Vrms	±2.5%	±5.0%	±7.5%	±3.0%	2.0 x R.V.	Plastic	2,000	10,000		
417		C3216C0G2A822J	3.20±0.20	1.60±0.20	1.15±0.15	1,000		1kHz	0.5-5Vrms	±2.5%	±5.0%	±7.5%	±3.0%	2.0 x R.V.	Plastic	2,000	10,000		
418		C3216C0G2A103J	3.20±0.20	1.60±0.20	1.15±0.15	1,000		1kHz	0.5-5Vrms	±2.5%	±5.0%	±7.5%	±3.0%	2.0 x R.V.	Plastic	2,000	10,000		
419		C3216C0G2E332J	3.20±0.20	1.60±0.20	0.85±0.15	1,000		1kHz	0.5-5Vrms	±2.5%	±5.0%	±7.5%	±3.0%	1.5 x R.V.	Paper	4,000	10,000		
420		C3216C0G2E392J	3.20±0.20	1.60±0.20	1.15±0.15	1,000		1kHz	0.5-5Vrms	±2.5%	±5.0%	±7.5%	±3.0%	1.5 x R.V.	Plastic	2,000	10,000		
421		C3216C0G2E472J	3.20±0.20	1.60±0.20	1.15±0.15	1,000		1kHz	0.5-5Vrms	±2.5%	±5.0%	±7.5%	±3.0%	1.5 x R.V.	Plastic	2,000	10,000		
422		C3216C0G2E562J	3.20±0.20	1.60±0.20	1.15±0.15	1,000		1kHz	0.5-5Vrms	±2.5%	±5.0%	±7.5%	±3.0%	1.5 x R.V.	Plastic	2,000	10,000		
423		C3216C0G2E682J	3.20±0.20	1.60±0.20	1.60±0.20	1,000		1kHz	0.5-5Vrms	±2.5%	±5.0%	±7.5%	±3.0%	1.5 x R.V.	Plastic	2,000	8,000		
424		C3216C0G2E822J	3.20±0.20	1.60±0.20	1.60±0.20	1,000		1kHz	0.5-5Vrms	±2.5%	±5.0%	±7.5%	±3.0%	1.5 x R.V.	Plastic	2,000	8,000		

No	Your Part No.	TDK product	Dimensions			Q (min.)	tanδ (max.)	Temp. Characteristics of Cap.		Temp cycle ΔC/C	Moisture Resistance (Steady state)		Moisture Resistance		Life		Tape packaging materials	Qty. per 1 reel	
			L (mm)	W (mm)	T (mm)			Measuring frequency	Measuring voltage		ΔC/C	ΔC/C	ΔC/C	ΔC/C	Test voltage	φ178mm		φ330mm	
425		C3216C0G2J101J	3.20±0.20	1.60±0.20	0.60±0.15	1,000		1MHz	0.5-5Vrms	±2.5%	±5.0%	±7.5%	±3.0%	1.2 x R.V.	Paper	4,000	10,000		
426		C3216C0G2J121J	3.20±0.20	1.60±0.20	0.60±0.15	1,000		1MHz	0.5-5Vrms	±2.5%	±5.0%	±7.5%	±3.0%	1.2 x R.V.	Paper	4,000	10,000		
427		C3216C0G2J151J	3.20±0.20	1.60±0.20	0.60±0.15	1,000		1MHz	0.5-5Vrms	±2.5%	±5.0%	±7.5%	±3.0%	1.2 x R.V.	Paper	4,000	10,000		
428		C3216C0G2J181J	3.20±0.20	1.60±0.20	0.60±0.15	1,000		1MHz	0.5-5Vrms	±2.5%	±5.0%	±7.5%	±3.0%	1.2 x R.V.	Paper	4,000	10,000		
429		C3216C0G2J221J	3.20±0.20	1.60±0.20	0.60±0.15	1,000		1MHz	0.5-5Vrms	±2.5%	±5.0%	±7.5%	±3.0%	1.2 x R.V.	Paper	4,000	10,000		
430		C3216C0G2J271J	3.20±0.20	1.60±0.20	0.60±0.15	1,000		1MHz	0.5-5Vrms	±2.5%	±5.0%	±7.5%	±3.0%	1.2 x R.V.	Paper	4,000	10,000		
431		C3216C0G2J331J	3.20±0.20	1.60±0.20	0.60±0.15	1,000		1MHz	0.5-5Vrms	±2.5%	±5.0%	±7.5%	±3.0%	1.2 x R.V.	Paper	4,000	10,000		
432		C3216C0G2J391J	3.20±0.20	1.60±0.20	0.60±0.15	1,000		1MHz	0.5-5Vrms	±2.5%	±5.0%	±7.5%	±3.0%	1.2 x R.V.	Paper	4,000	10,000		
433		C3216C0G2J471J	3.20±0.20	1.60±0.20	0.85±0.15	1,000		1MHz	0.5-5Vrms	±2.5%	±5.0%	±7.5%	±3.0%	1.2 x R.V.	Paper	4,000	10,000		
434		C3216C0G2J561J	3.20±0.20	1.60±0.20	0.85±0.15	1,000		1MHz	0.5-5Vrms	±2.5%	±5.0%	±7.5%	±3.0%	1.2 x R.V.	Paper	4,000	10,000		
435		C3216C0G2J681J	3.20±0.20	1.60±0.20	0.85±0.15	1,000		1MHz	0.5-5Vrms	±2.5%	±5.0%	±7.5%	±3.0%	1.2 x R.V.	Paper	4,000	10,000		
436		C3216C0G2J821J	3.20±0.20	1.60±0.20	0.85±0.15	1,000		1MHz	0.5-5Vrms	±2.5%	±5.0%	±7.5%	±3.0%	1.2 x R.V.	Paper	4,000	10,000		
437		C3216C0G2J102J	3.20±0.20	1.60±0.20	0.85±0.15	1,000		1MHz	0.5-5Vrms	±2.5%	±5.0%	±7.5%	±3.0%	1.2 x R.V.	Paper	4,000	10,000		
438		C3216C0G2J122J	3.20±0.20	1.60±0.20	0.85±0.15	1,000		1kHz	0.5-5Vrms	±2.5%	±5.0%	±7.5%	±3.0%	1.2 x R.V.	Paper	4,000	10,000		
439		C3216C0G2J152J	3.20±0.20	1.60±0.20	1.15±0.15	1,000		1kHz	0.5-5Vrms	±2.5%	±5.0%	±7.5%	±3.0%	1.2 x R.V.	Plastic	2,000	10,000		
440		C3216C0G2J182J	3.20±0.20	1.60±0.20	1.15±0.15	1,000		1kHz	0.5-5Vrms	±2.5%	±5.0%	±7.5%	±3.0%	1.2 x R.V.	Plastic	2,000	10,000		
441		C3216C0G2J222J	3.20±0.20	1.60±0.20	1.15±0.15	1,000		1kHz	0.5-5Vrms	±2.5%	±5.0%	±7.5%	±3.0%	1.2 x R.V.	Plastic	2,000	10,000		
442		C3216C0G2J272J	3.20±0.20	1.60±0.20	1.60±0.20	1,000		1kHz	0.5-5Vrms	±2.5%	±5.0%	±7.5%	±3.0%	1.2 x R.V.	Plastic	2,000	8,000		
443		C3216C0G2J332J	3.20±0.20	1.60±0.20	1.60±0.20	1,000		1kHz	0.5-5Vrms	±2.5%	±5.0%	±7.5%	±3.0%	1.2 x R.V.	Plastic	2,000	8,000		
444		C3225C0G2A153K	3.20±0.40	2.50±0.30	1.25±0.20	1,000		1kHz	0.5-5Vrms	±2.5%	±5.0%	±7.5%	±3.0%	2.0 x R.V.	Plastic	2,000	8,000		
445		C3225C0G2A223K	3.20±0.40	2.50±0.30	1.60±0.20	1,000		1kHz	0.5-5Vrms	±2.5%	±5.0%	±7.5%	±3.0%	2.0 x R.V.	Plastic	2,000	8,000		
446		C3225C0G2A333K	3.20±0.40	2.50±0.30	2.00±0.20	1,000		1kHz	0.5-5Vrms	±2.5%	±5.0%	±7.5%	±3.0%	2.0 x R.V.	Plastic	1,000	5,000		
447		C3225C0G2A473K	3.20±0.40	2.50±0.30	2.30±0.20	1,000		1kHz	0.5-5Vrms	±2.5%	±5.0%	±7.5%	±3.0%	2.0 x R.V.	Plastic	1,000	5,000		
448		C3225C0G2E103J	3.20±0.40	2.50±0.30	1.60±0.20	1,000		1kHz	0.5-5Vrms	±2.5%	±5.0%	±7.5%	±3.0%	1.5 x R.V.	Plastic	2,000	8,000		
449		C3225C0G2E153K	3.20±0.40	2.50±0.30	2.00±0.20	1,000		1kHz	0.5-5Vrms	±2.5%	±5.0%	±7.5%	±3.0%	1.5 x R.V.	Plastic	1,000	5,000		
450		C3225C0G2J392J	3.20±0.40	2.50±0.30	1.25±0.20	1,000		1kHz	0.5-5Vrms	±2.5%	±5.0%	±7.5%	±3.0%	1.2 x R.V.	Plastic	2,000	8,000		
451		C3225C0G2J472J	3.20±0.40	2.50±0.30	1.60±0.20	1,000		1kHz	0.5-5Vrms	±2.5%	±5.0%	±7.5%	±3.0%	1.2 x R.V.	Plastic	2,000	8,000		
452		C3225C0G2J562J	3.20±0.40	2.50±0.30	1.60±0.20	1,000		1kHz	0.5-5Vrms	±2.5%	±5.0%	±7.5%	±3.0%	1.2 x R.V.	Plastic	2,000	8,000		
453		C3225C0G2J682J	3.20±0.40	2.50±0.30	2.00±0.20	1,000		1kHz	0.5-5Vrms	±2.5%	±5.0%	±7.5%	±3.0%	1.2 x R.V.	Plastic	1,000	5,000		
454		C4532C0G2A683K	4.50±0.40	3.20±0.40	2.50±0.30	1,000		1kHz	0.5-5Vrms	±2.5%	±5.0%	±7.5%	±3.0%	2.0 x R.V.	Plastic	500	3,000		
455		C4532C0G2A104K	4.50±0.40	3.20±0.40	3.20±0.40	1,000		1kHz	0.5-5Vrms	±2.5%	±5.0%	±7.5%	±3.0%	2.0 x R.V.	Plastic	500	2,000		
456		C4532C0G2E223K	4.50±0.40	3.20±0.40	1.60±0.20	1,000		1kHz	0.5-5Vrms	±2.5%	±5.0%	±7.5%	±3.0%	1.5 x R.V.	Plastic	1,000	3,000		
457		C4532C0G2E333K	4.50±0.40	3.20±0.40	2.00±0.20	1,000		1kHz	0.5-5Vrms	±2.5%	±5.0%	±7.5%	±3.0%	1.5 x R.V.	Plastic	1,000	3,000		
458		C4532C0G2E473K	4.50±0.40	3.20±0.40	3.20±0.40	1,000		1kHz	0.5-5Vrms	±2.5%	±5.0%	±7.5%	±3.0%	1.5 x R.V.	Plastic	500	2,000		
459		C4532C0G2J822J	4.50±0.40	3.20±0.40	1.60±0.20	1,000		1kHz	0.5-5Vrms	±2.5%	±5.0%	±7.5%	±3.0%	1.2 x R.V.	Plastic	1,000	3,000		
460		C4532C0G2J103J	4.50±0.40	3.20±0.40	1.60±0.20	1,000		1kHz	0.5-5Vrms	±2.5%	±5.0%	±7.5%	±3.0%	1.2 x R.V.	Plastic	1,000	3,000		
461		C4532C0G2J153K	4.50±0.40	3.20±0.40	2.50±0.30	1,000		1kHz	0.5-5Vrms	±2.5%	±5.0%	±7.5%	±3.0%	1.2 x R.V.	Plastic	500	3,000		
462		C4532C0G2J223K	4.50±0.40	3.20±0.40	3.20±0.40	1,000		1kHz	0.5-5Vrms	±2.5%	±5.0%	±7.5%	±3.0%	1.2 x R.V.	Plastic	500	2,000		

No	Your Part No.	TDK product	Dimensions			Q (min.)	tanδ (max.)	Temp. Characteristics of Cap.		Temp cycle ΔC/C	Moisture Resistance (Steady state) ΔC/C	Moisture Resistance ΔC/C	Life		Tape packaging materials	Qty. per 1 reel	
			L (mm)	W (mm)	T (mm)			Measuring frequency	Measuring voltage				ΔC/C	Test voltage		φ178mm	φ330mm
463		C1608X7R2A102K	1.60±0.10	0.80±0.10	0.80±0.10		0.03	1kHz	1.0Vrms	±7.5%	±12.5%	±12.5%	±15%	2.0 x R.V.	Paper	4,000	10,000
464		C1608X7R2A152K	1.60±0.10	0.80±0.10	0.80±0.10		0.03	1kHz	1.0Vrms	±7.5%	±12.5%	±12.5%	±15%	2.0 x R.V.	Paper	4,000	10,000
465		C1608X7R2A222K	1.60±0.10	0.80±0.10	0.80±0.10		0.03	1kHz	1.0Vrms	±7.5%	±12.5%	±12.5%	±15%	2.0 x R.V.	Paper	4,000	10,000
466		C1608X7R2A332K	1.60±0.10	0.80±0.10	0.80±0.10		0.03	1kHz	1.0Vrms	±7.5%	±12.5%	±12.5%	±15%	2.0 x R.V.	Paper	4,000	10,000
467		C1608X7R2A472K	1.60±0.10	0.80±0.10	0.80±0.10		0.03	1kHz	1.0Vrms	±7.5%	±12.5%	±12.5%	±15%	2.0 x R.V.	Paper	4,000	10,000
468		C1608X7R2A682K	1.60±0.10	0.80±0.10	0.80±0.10		0.03	1kHz	1.0Vrms	±7.5%	±12.5%	±12.5%	±15%	2.0 x R.V.	Paper	4,000	10,000
469		C1608X7R2A103K	1.60±0.10	0.80±0.10	0.80±0.10		0.03	1kHz	1.0Vrms	±7.5%	±12.5%	±12.5%	±15%	2.0 x R.V.	Paper	4,000	10,000
470		C1608X7R2A153K	1.60±0.10	0.80±0.10	0.80±0.10		0.03	1kHz	1.0Vrms	±7.5%	±12.5%	±12.5%	±15%	2.0 x R.V.	Paper	4,000	10,000
471		C1608X7R2A223K	1.60±0.10	0.80±0.10	0.80±0.10		0.03	1kHz	1.0Vrms	±7.5%	±12.5%	±12.5%	±15%	2.0 x R.V.	Paper	4,000	10,000
472		C2012X7R2A333K	2.00±0.20	1.25±0.20	1.25±0.20		0.03	1kHz	1.0Vrms	±7.5%	±12.5%	±12.5%	±15%	2.0 x R.V.	Plastic	2,000	10,000
473		C2012X7R2A473K	2.00±0.20	1.25±0.20	1.25±0.20		0.03	1kHz	1.0Vrms	±7.5%	±12.5%	±12.5%	±15%	2.0 x R.V.	Plastic	2,000	10,000
474		C2012X7R2A683K	2.00±0.20	1.25±0.20	0.85±0.15		0.03	1kHz	1.0Vrms	±7.5%	±12.5%	±12.5%	±15%	2.0 x R.V.	Paper	4,000	10,000
475		C2012X7R2A104K	2.00±0.20	1.25±0.20	1.25±0.20		0.03	1kHz	1.0Vrms	±7.5%	±12.5%	±12.5%	±15%	2.0 x R.V.	Plastic	2,000	10,000
476		C2012X7R2E102K	2.00±0.20	1.25±0.20	0.85±0.15		0.03	1kHz	1.0Vrms	±7.5%	±12.5%	±12.5%	±15%	1.5 x R.V.	Paper	4,000	10,000
477		C2012X7R2E152K	2.00±0.20	1.25±0.20	0.85±0.15		0.03	1kHz	1.0Vrms	±7.5%	±12.5%	±12.5%	±15%	1.5 x R.V.	Paper	4,000	10,000
478		C2012X7R2E222K	2.00±0.20	1.25±0.20	0.85±0.15		0.03	1kHz	1.0Vrms	±7.5%	±12.5%	±12.5%	±15%	1.5 x R.V.	Paper	4,000	10,000
479		C2012X7R2E332K	2.00±0.20	1.25±0.20	0.85±0.15		0.03	1kHz	1.0Vrms	±7.5%	±12.5%	±12.5%	±15%	1.5 x R.V.	Paper	4,000	10,000
480		C2012X7R2E472K	2.00±0.20	1.25±0.20	0.85±0.15		0.03	1kHz	1.0Vrms	±7.5%	±12.5%	±12.5%	±15%	1.5 x R.V.	Paper	4,000	10,000
481		C2012X7R2E682K	2.00±0.20	1.25±0.20	1.25±0.20		0.03	1kHz	1.0Vrms	±7.5%	±12.5%	±12.5%	±15%	1.5 x R.V.	Plastic	2,000	10,000
482		C2012X7R2E103K	2.00±0.20	1.25±0.20	1.25±0.20		0.03	1kHz	1.0Vrms	±7.5%	±12.5%	±12.5%	±15%	1.5 x R.V.	Plastic	2,000	10,000
483		C2012X7R2E153K	2.00±0.20	1.25±0.20	1.25±0.20		0.03	1kHz	1.0Vrms	±7.5%	±12.5%	±12.5%	±15%	1.5 x R.V.	Plastic	2,000	10,000
484		C2012X7R2E223K	2.00±0.20	1.25±0.20	1.25±0.20		0.03	1kHz	1.0Vrms	±7.5%	±12.5%	±12.5%	±15%	1.5 x R.V.	Plastic	2,000	10,000
485		C3216X7R2A154K	3.20±0.20	1.60±0.20	1.60±0.20		0.03	1kHz	1.0Vrms	±7.5%	±12.5%	±12.5%	±15%	2.0 x R.V.	Plastic	2,000	8,000
486		C3216X7R2A224K	3.20±0.20	1.60±0.20	1.15±0.15		0.03	1kHz	1.0Vrms	±7.5%	±12.5%	±12.5%	±15%	2.0 x R.V.	Plastic	2,000	10,000
487		C3216X7R2A334K	3.20±0.20	1.60±0.20	1.30±0.20		0.03	1kHz	1.0Vrms	±7.5%	±12.5%	±12.5%	±15%	2.0 x R.V.	Plastic	2,000	10,000
488		C3216X7R2A474K	3.20±0.20	1.60±0.20	1.60±0.20		0.03	1kHz	1.0Vrms	±7.5%	±12.5%	±12.5%	±15%	2.0 x R.V.	Plastic	2,000	8,000
489		C3216X7R2A105K	3.20±0.20	1.60±0.20	1.60±0.20		0.03	1kHz	1.0Vrms	±7.5%	±12.5%	±12.5%	±15%	2.0 x R.V.	Plastic	2,000	8,000
490		C3216X7R2E333K	3.20±0.20	1.60±0.20	1.60±0.20		0.03	1kHz	1.0Vrms	±7.5%	±12.5%	±12.5%	±15%	1.5 x R.V.	Plastic	2,000	8,000
491		C3216X7R2E473K	3.20±0.20	1.60±0.20	1.60±0.20		0.03	1kHz	1.0Vrms	±7.5%	±12.5%	±12.5%	±15%	1.5 x R.V.	Plastic	2,000	8,000
492		C3216X7R2E683K	3.20±0.20	1.60±0.20	1.60±0.20		0.03	1kHz	1.0Vrms	±7.5%	±12.5%	±12.5%	±15%	1.5 x R.V.	Plastic	2,000	8,000
493		C3216X7R2E104K	3.20±0.20	1.60±0.20	1.60±0.20		0.03	1kHz	1.0Vrms	±7.5%	±12.5%	±12.5%	±15%	1.5 x R.V.	Plastic	2,000	8,000
494		C3216X7R2J102K	3.20±0.20	1.60±0.20	1.15±0.15		0.03	1kHz	1.0Vrms	±7.5%	±12.5%	±12.5%	±15%	1.2 x R.V.	Plastic	2,000	10,000
495		C3216X7R2J152K	3.20±0.20	1.60±0.20	1.15±0.15		0.03	1kHz	1.0Vrms	±7.5%	±12.5%	±12.5%	±15%	1.2 x R.V.	Plastic	2,000	10,000
496		C3216X7R2J222K	3.20±0.20	1.60±0.20	1.15±0.15		0.03	1kHz	1.0Vrms	±7.5%	±12.5%	±12.5%	±15%	1.2 x R.V.	Plastic	2,000	10,000
497		C3216X7R2J332K	3.20±0.20	1.60±0.20	1.15±0.15		0.03	1kHz	1.0Vrms	±7.5%	±12.5%	±12.5%	±15%	1.2 x R.V.	Plastic	2,000	10,000
498		C3216X7R2J472K	3.20±0.20	1.60±0.20	1.15±0.15		0.03	1kHz	1.0Vrms	±7.5%	±12.5%	±12.5%	±15%	1.2 x R.V.	Plastic	2,000	10,000
499		C3216X7R2J682K	3.20±0.20	1.60±0.20	1.15±0.15		0.03	1kHz	1.0Vrms	±7.5%	±12.5%	±12.5%	±15%	1.2 x R.V.	Plastic	2,000	10,000
500		C3216X7R2J103K	3.20±0.20	1.60±0.20	1.15±0.15		0.03	1kHz	1.0Vrms	±7.5%	±12.5%	±12.5%	±15%	1.2 x R.V.	Plastic	2,000	10,000
501		C3216X7R2J153K	3.20±0.20	1.60±0.20	1.30±0.20		0.03	1kHz	1.0Vrms	±7.5%	±12.5%	±12.5%	±15%	1.2 x R.V.	Plastic	2,000	10,000
502		C3216X7R2J223K	3.20±0.20	1.60±0.20	1.30±0.20		0.03	1kHz	1.0Vrms	±7.5%	±12.5%	±12.5%	±15%	1.2 x R.V.	Plastic	2,000	10,000
503		C3216X7R2J333K	3.20±0.20	1.60±0.20	1.60±0.20		0.03	1kHz	1.0Vrms	±7.5%	±12.5%	±12.5%	±15%	1.2 x R.V.	Plastic	2,000	8,000

No	Your Part No.	TDK product	Dimensions			Q (min.)	tanδ (max.)	Temp. Characteristics of Cap.		Temp cycle ΔC/C	Moisture Resistance (Steady state) ΔC/C	Moisture Resistance ΔC/C	Life		Tape packaging materials	Qty. per 1 reel	
			L (mm)	W (mm)	T (mm)			Measuring frequency	Measuring voltage				ΔC/C	Test voltage		φ178mm	φ330mm
504		C3225X7R2A684K	3.20±0.40	2.50±0.30	1.60±0.20		0.03	1kHz	1.0Vrms	±7.5%	±12.5%	±12.5%	±15%	2.0 x R.V.	Plastic	2,000	8,000
505		C3225X7R2A105K	3.20±0.40	2.50±0.30	2.00±0.20		0.03	1kHz	1.0Vrms	±7.5%	±12.5%	±12.5%	±15%	2.0 x R.V.	Plastic	1,000	5,000
506		C3225X7R2A225K	3.20±0.40	2.50±0.30	2.30±0.20		0.03	1kHz	1.0Vrms	±7.5%	±12.5%	±12.5%	±15%	1.5 x R.V.	Plastic	1,000	5,000
507		C3225X7R2E154K	3.20±0.40	2.50±0.30	2.00±0.20		0.03	1kHz	1.0Vrms	±7.5%	±12.5%	±12.5%	±15%	1.5 x R.V.	Plastic	1,000	5,000
508		C3225X7R2E224K	3.20±0.40	2.50±0.30	2.00±0.20		0.03	1kHz	1.0Vrms	±7.5%	±12.5%	±12.5%	±15%	1.5 x R.V.	Plastic	1,000	5,000
509		C3225X7R2J473K	3.20±0.40	2.50±0.30	2.00±0.20		0.03	1kHz	1.0Vrms	±7.5%	±12.5%	±12.5%	±15%	1.2 x R.V.	Plastic	1,000	5,000
510		C3225X7R2J683K	3.20±0.40	2.50±0.30	2.00±0.20		0.03	1kHz	1.0Vrms	±7.5%	±12.5%	±12.5%	±15%	1.2 x R.V.	Plastic	1,000	5,000
511		C4532X7R2A155K	4.50±0.40	3.20±0.40	2.30±0.20		0.03	1kHz	1.0Vrms	±7.5%	±12.5%	±12.5%	±15%	2.0 x R.V.	Plastic	500	3,000
512		C4532X7R2A225K	4.50±0.40	3.20±0.40	2.30±0.20		0.03	1kHz	1.0Vrms	±7.5%	±12.5%	±12.5%	±15%	2.0 x R.V.	Plastic	500	3,000
513		C4532X7R2E334K	4.50±0.40	3.20±0.40	2.30±0.20		0.03	1kHz	1.0Vrms	±7.5%	±12.5%	±12.5%	±15%	1.5 x R.V.	Plastic	500	3,000
514		C4532X7R2E474K	4.50±0.40	3.20±0.40	2.30±0.20		0.03	1kHz	1.0Vrms	±7.5%	±12.5%	±12.5%	±15%	1.5 x R.V.	Plastic	500	3,000
515		C4532X7R2J104K	4.50±0.40	3.20±0.40	2.30±0.20		0.03	1kHz	1.0Vrms	±7.5%	±12.5%	±12.5%	±15%	1.2 x R.V.	Plastic	500	3,000
516		C5750X7R2A335K	5.70±0.40	5.00±0.40	2.30±0.20		0.03	1kHz	1.0Vrms	±7.5%	±12.5%	±12.5%	±15%	2.0 x R.V.	Plastic	500	3,000
517		C5750X7R2A475K	5.70±0.40	5.00±0.40	2.30±0.20		0.03	1kHz	1.0Vrms	±7.5%	±12.5%	±12.5%	±15%	2.0 x R.V.	Plastic	500	3,000
518		C5750X7R2E684K	5.70±0.40	5.00±0.40	2.30±0.20		0.03	1kHz	1.0Vrms	±7.5%	±12.5%	±12.5%	±15%	1.5 x R.V.	Plastic	500	3,000
519		C5750X7R2E105K	5.70±0.40	5.00±0.40	2.30±0.20		0.03	1kHz	1.0Vrms	±7.5%	±12.5%	±12.5%	±15%	1.5 x R.V.	Plastic	500	3,000
520		C5750X7R2J154K	5.70±0.40	5.00±0.40	1.60±0.20		0.03	1kHz	1.0Vrms	±7.5%	±12.5%	±12.5%	±15%	1.2 x R.V.	Plastic	1,000	3,000
521		C5750X7R2J224K	5.70±0.40	5.00±0.40	2.30±0.20		0.03	1kHz	1.0Vrms	±7.5%	±12.5%	±12.5%	±15%	1.2 x R.V.	Plastic	500	3,000

Note:

Table A lists the TDK part number offering and the applicable guaranteed specifications. Please contact your TDK sales representative for product availability