

## FLORENCE-1R-UP

Asymmetric beam for uplighting

### TECHNICAL SPECIFICATIONS:

Dimensions	285.6 x 19.51 mm
Height	6.9 mm
Fastening	clips
Colour	clear
Box size	480 x 280 x 300 mm
Box weight	0 kg
Quantity in Box	210 pcs
ROHS compliant	yes ⓘ



### MATERIAL SPECIFICATIONS:

Component	Type	Material	Colour
FLORENCE-1R-UP	Lens	PMMA	clear

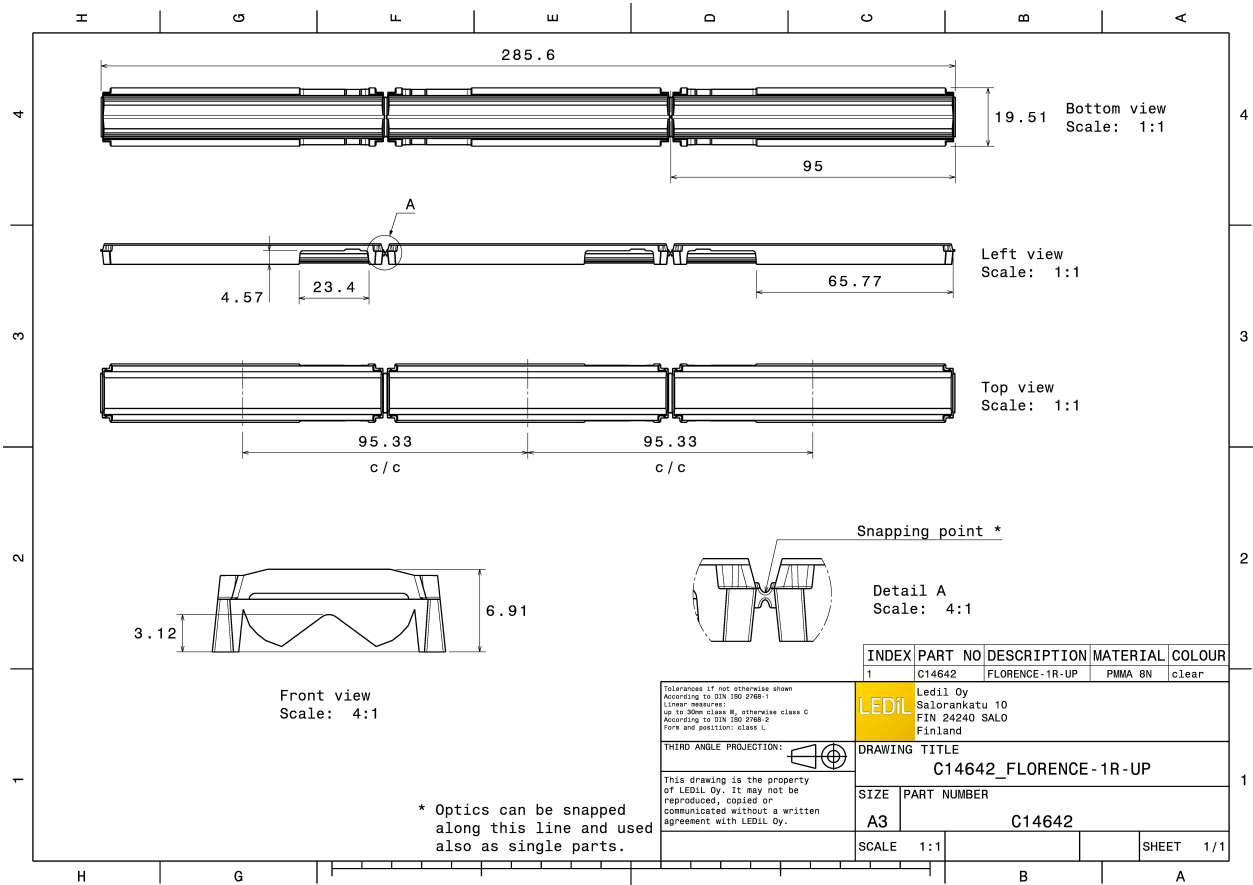

#### PHOTOMETRIC DATA (MEASURED):



LED CALGD0414-M8W1  
 FWHM Asymmetric  
 Efficiency 90 %  
 Peak intensity 0.370 cd/lm  
 Required components:

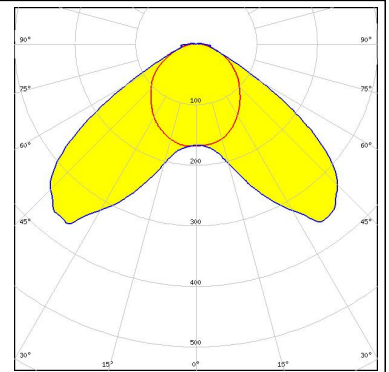

LED CALGD0814-M17W1  
 FWHM Asymmetric  
 Efficiency 90 %  
 Peak intensity 0.370 cd/lm  
 Required components:

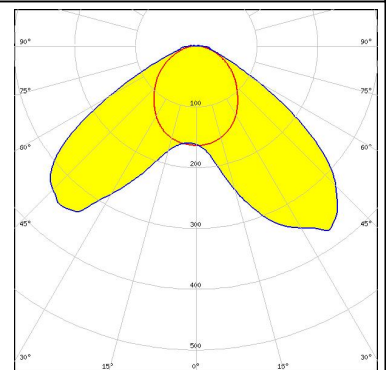

LED L0-280024-xxx-C0800-L267  
 FWHM Asymmetric  
 Efficiency 90 %  
 Peak intensity 0.330 cd/lm  
 Required components:

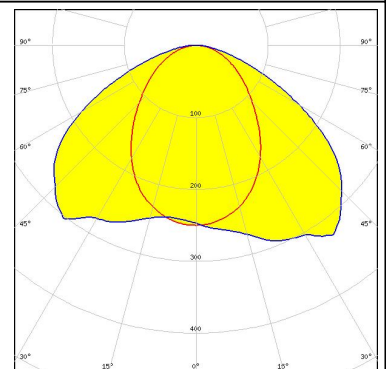
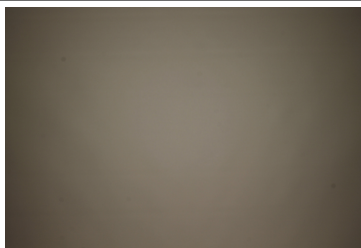

LED XH-B/G  
 FWHM Asymmetric  
 Efficiency 89 %  
 Peak intensity 0.290 cd/lm  
 Required components:

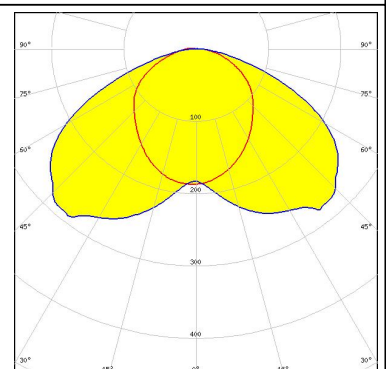
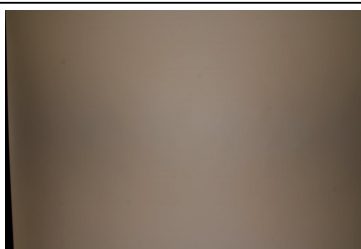

#### PHOTOMETRIC DATA (MEASURED):



LED XP-E  
FWHM Asymmetric  
Efficiency 90 %  
Peak intensity 0.340 cd/lm  
Required components:

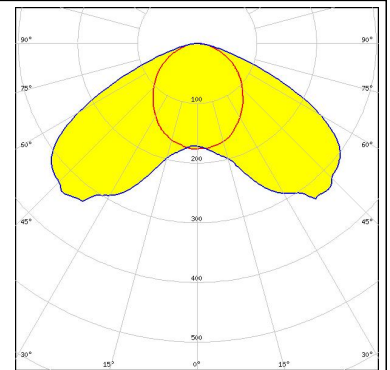

LED XP-G2  
FWHM Asymmetric  
Efficiency 90 %  
Peak intensity 0.310 cd/lm  
Required components:

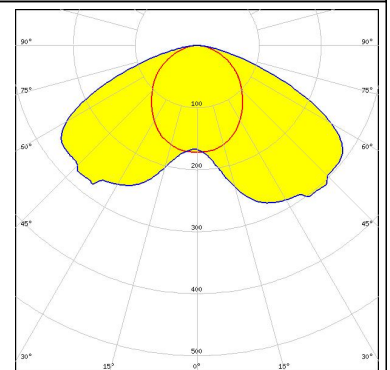

LED LUXEON 3014  
FWHM Asymmetric  
Efficiency 92 %  
Peak intensity 0.390 cd/lm  
Required components:

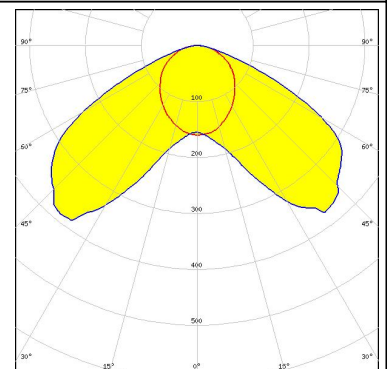
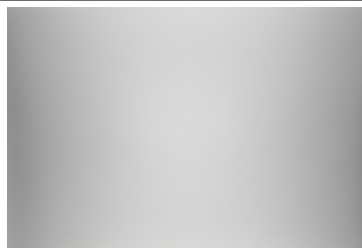

LED LUXEON 3020  
FWHM Asymmetric  
Efficiency 92 %  
Peak intensity 0.390 cd/lm  
Required components:

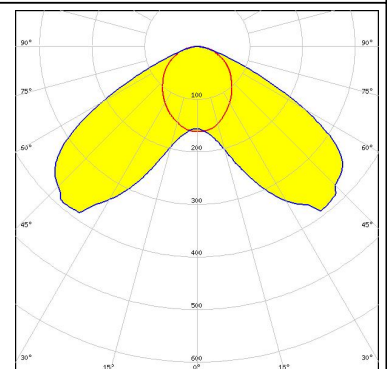
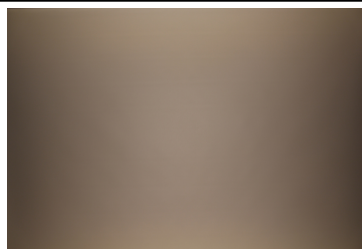

#### PHOTOMETRIC DATA (MEASURED):

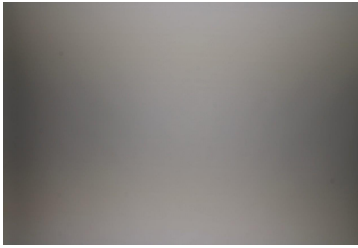
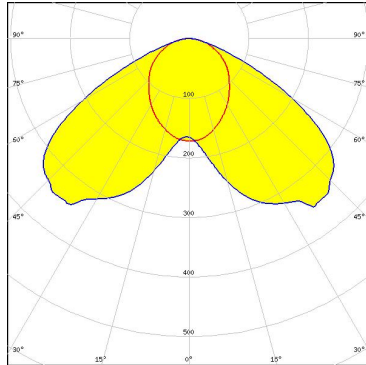
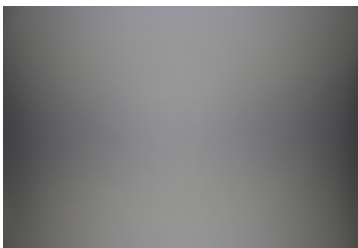
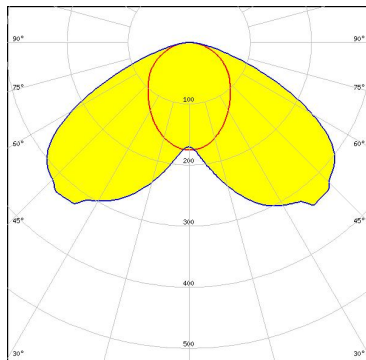
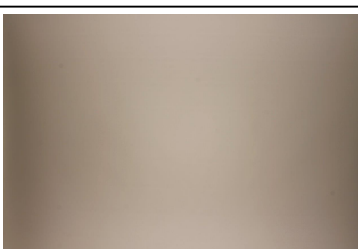
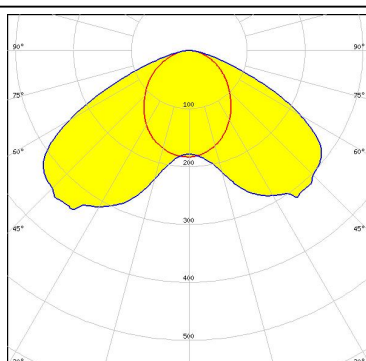
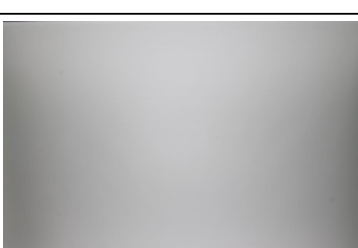
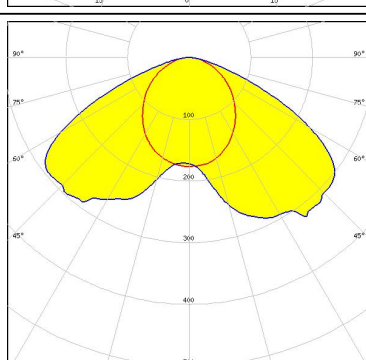
<p><b>LUMILEDS</b></p> <p>LED            LUXEON 3030 2D</p> <p>FWHM        Asymmetric</p> <p>Efficiency    90 %</p> <p>Peak intensity 0.350 cd/lm</p> <p>Required components:</p>		
<p><b>LUMILEDS</b></p> <p>LED            LUXEON 3535L</p> <p>FWHM        Asymmetric</p> <p>Efficiency    92 %</p> <p>Peak intensity 0.340 cd/lm</p> <p>Required components:</p>		
<p><b>LUMILEDS</b></p> <p>LED            LUXEON Rebel</p> <p>FWHM        Asymmetric</p> <p>Efficiency    91 %</p> <p>Peak intensity 0.340 cd/lm</p> <p>Required components:</p>		
<p><b>LUMILEDS</b></p> <p>LED            LUXEON Rebel ES</p> <p>FWHM        Asymmetric</p> <p>Efficiency    91 %</p> <p>Peak intensity 0.320 cd/lm</p> <p>Required components:</p>		

#### PHOTOMETRIC DATA (MEASURED):



LED NCSxx19B  
 FWHM Asymmetric  
 Efficiency 90 %  
 Peak intensity 0.330 cd/lm  
 Required components:

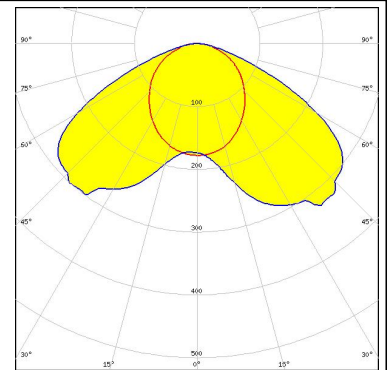

LED NF2x757G  
 FWHM Asymmetric  
 Efficiency 90 %  
 Peak intensity 0.340 cd/lm  
 Required components:

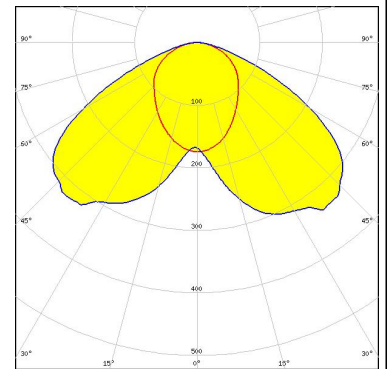
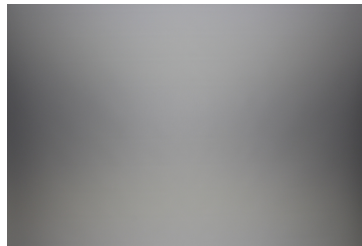

LED Duris S5 (2 chip)  
 FWHM Asymmetric  
 Efficiency 91 %  
 Peak intensity 0.340 cd/lm  
 Required components:

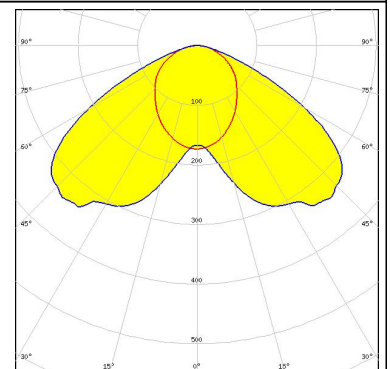
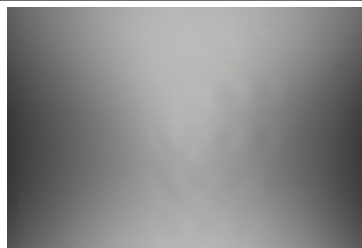

LED Oslon SSL 80  
 FWHM Asymmetric  
 Efficiency 92 %  
 Peak intensity 0.450 cd/lm  
 Required components:

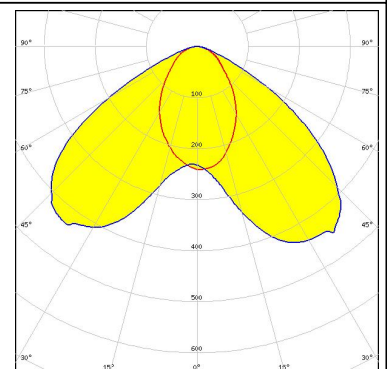
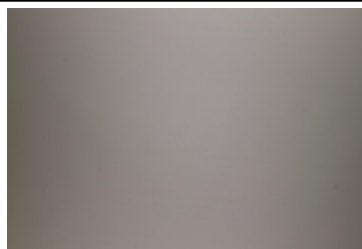

#### PHOTOMETRIC DATA (MEASURED):

### PHILIPS

LED Fortimo LED Line 1ft 1100lm xx0 1R xV2/x  
FWHM Asymmetric  
Efficiency 94 %  
Peak intensity 0.350 cd/lm  
Required components:

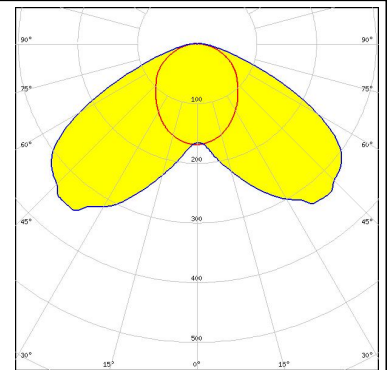

### PHILIPS

LED Fortimo LED Line 1ft 2000lm 8x0 1R HV1/HV2  
FWHM Asymmetric  
Efficiency 92 %  
Peak intensity 0.330 cd/lm  
Required components:  
C14353\_FLORENCE-1R-CLIP-A

### SAMSUNG

LED LM28xB Series  
FWHM Asymmetric  
Efficiency 92 %  
Peak intensity 0.360 cd/lm  
Required components:

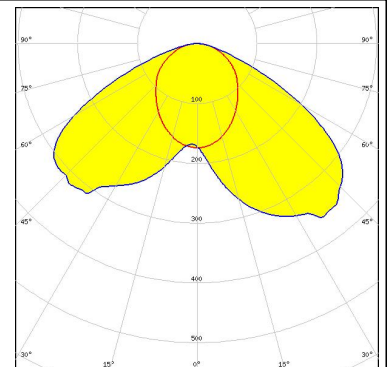
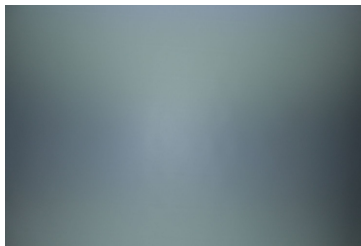

### SAMSUNG

LED LM301A  
FWHM Asymmetric  
Efficiency 90 %  
Peak intensity 0.360 cd/lm  
Required components:

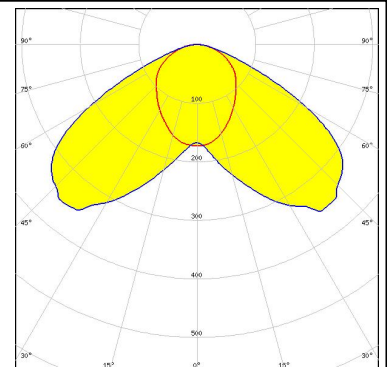
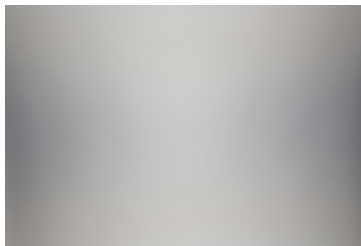

**PHOTOMETRIC DATA (MEASURED):**

**SAMSUNG**

LED LM561C  
FWHM Asymmetric  
Efficiency 91 %  
Peak intensity 0.360 cd/lm  
Required components:

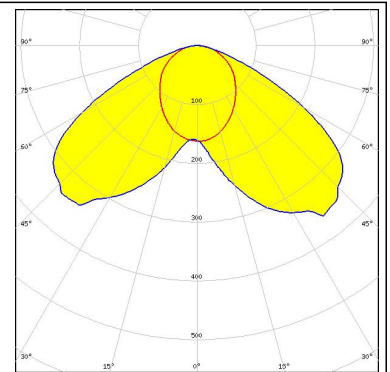
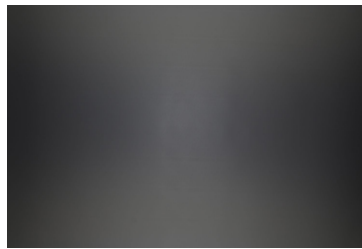

**SAMSUNG**

LED LT-S282N  
FWHM Asymmetric  
Efficiency 92 %  
Peak intensity 0.520 cd/lm  
Required components:

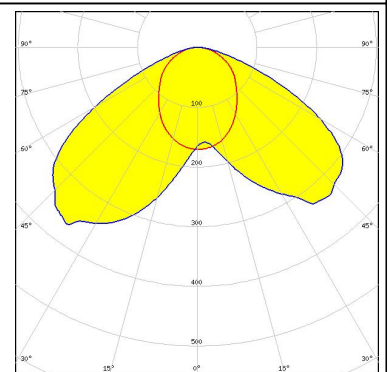

LED SEOUL 3030  
FWHM Asymmetric  
Efficiency 91 %  
Peak intensity 0.330 cd/lm  
Required components:

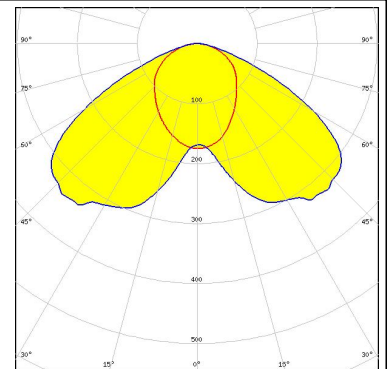
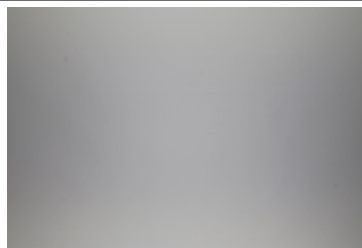

LED SunLike 3030  
FWHM Asymmetric  
Efficiency 92 %  
Peak intensity 0.400 cd/lm  
Required components:  
C14353\_FLORENCE-1R-CLIP-A

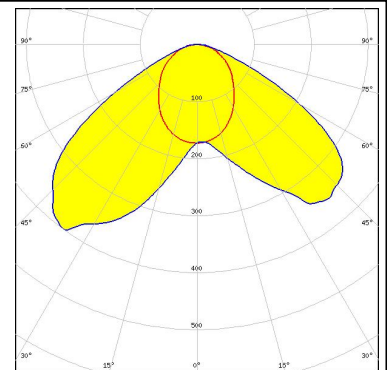

## PHOTOMETRIC DATA (SIMULATED):

**OSRAM**  
Opto Semiconductors

LED Duris E 2835  
FWHM Asymmetric  
Efficiency 88 %  
Peak intensity 0.320 cd/lm  
Required components:

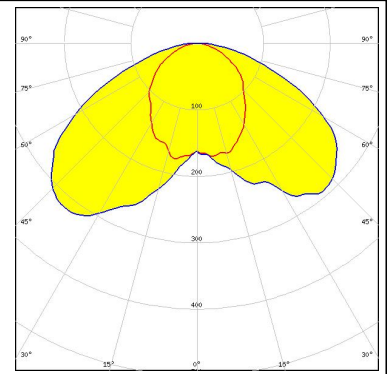

#### GENERAL INFORMATION:

NOTE: The typical beam angle will be changed by different color, chip size and chip position tolerance. The typical total beam angle is the full angle measured where the luminous intensity is half of the peak value.

#### MATERIALS:

As part of our continuous research and improvement processes, and to ensure the best possible quality and availability of our products, LEDiL reserves the right to change material grades without notice.

#### PRODUCT DATA USER AGREEMENT AND DISCLAIMER:

The measured data in the provided downloadable LEDiL Product Datasheets and Mechanical 2D-Drawings is rounded and provided as reference for planning. LEDiL Oy's optical specifications have been verified by conducting performance testing of the products in accordance with the company's quality system. The reported data are averaged results of multiple measurements with typical variation. LEDiL Oy reserves the right to without prior notification make changes and improvements to its products.

LEDiL Oy assumes neither warranty, nor guarantee nor any other liability of any kind for the contents and correctness of the provided data. The provided data has been generated with highest diligence but the provided data may in reality not represent the complete possible variation range of all intrinsic parameters. Therefore, in certain cases a deviation from the provided data could occur.

LEDiL Oy reserves the right to undertake technical changes of its products without further notification which could lead to changes in the provided data. LEDiL Oy assumes no liability of any kind for the possible deviation from any provided data or any other damage resulting from the usage of the provided data.

The user agrees to this disclaimer and user agreement with the download or usage of the provided files.

#### LEDiL Oy

Joensuunkatu 13  
FI-24240 SALO  
Finland

#### LEDiL Inc.

228 West Page Street  
Suite D  
Sycamore IL 60178  
USA

#### Local sales and technical support

[www.ledil.com/  
where\\_to\\_buy](http://www.ledil.com/where_to_buy)

#### Shipping locations

Salo, Finland  
Hong Kong, China

#### Distribution Partners

[www.ledil.com/  
where\\_to\\_buy](http://www.ledil.com/where_to_buy)