

## STRADA-2X2-ME-WIDE1

Beam with excellent longitudinal luminance uniformity fulfilling EN13201 M-class requirements where road width is equal to or less than the pole height. Added house-side backlight.

### TECHNICAL SPECIFICATIONS:

Dimensions	50x50 mm
Height	8.3 mm
Fastening	glue, screw, pin
Colour	clear
Box size	480 x 280 x 300 mm
Box weight	7.9 kg
Quantity in Box	800 pcs
ROHS compliant	yes ⓘ



### MATERIAL SPECIFICATIONS:

Component	Type	Material	Colour
STRADA-2X2-ME-WIDE1	Lens array	PMMA	clear

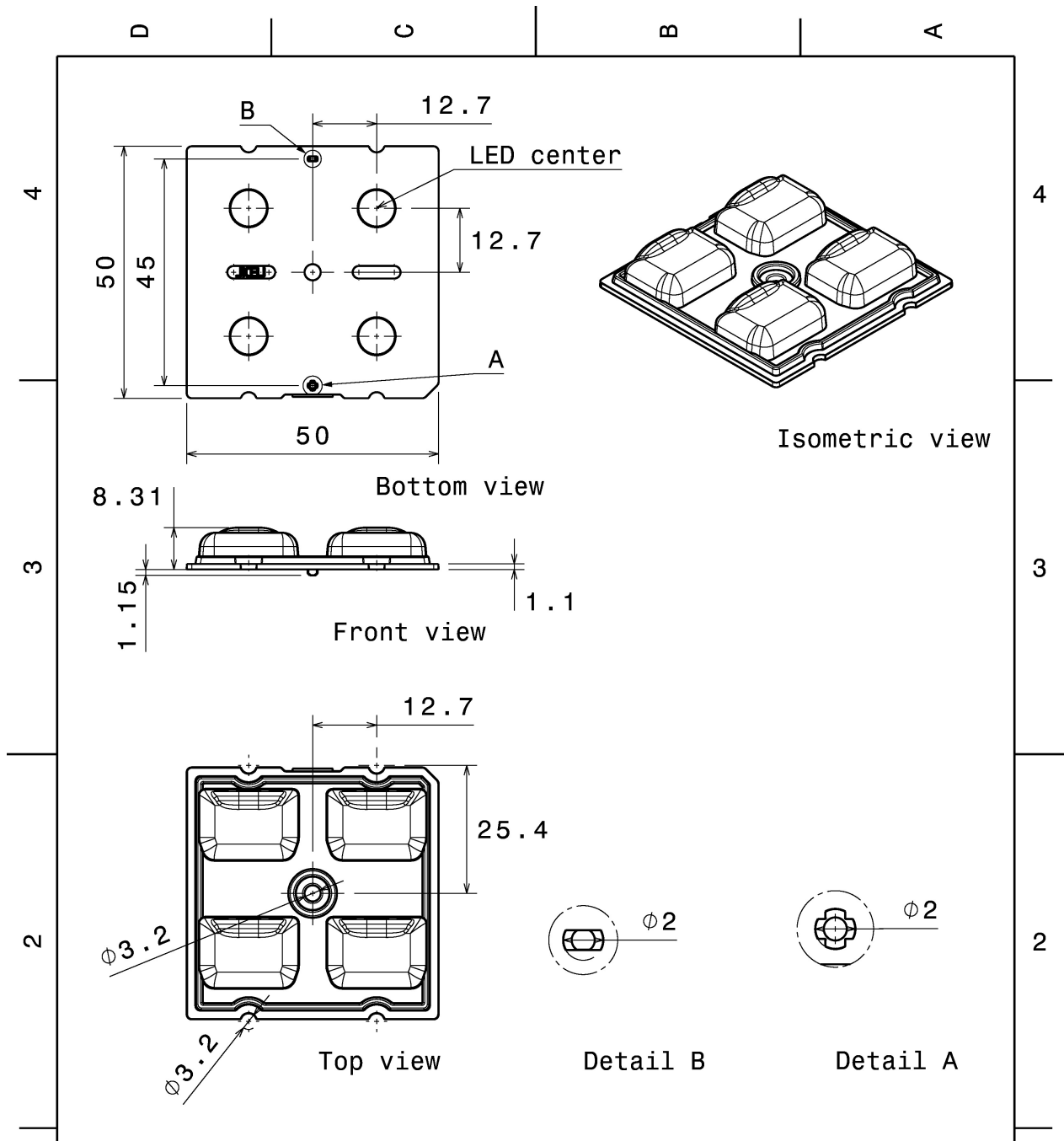

Tolerances if not otherwise shown  
According to DIN ISO 2768-1  
Linear measures:  
Up to 30mm class M, otherwise class C.  
According to DIN ISO 2768-2  
Form and position: class L

**LEDiL** Ledil Oy  
Salorankatu 10  
FIN 24240 SALO  
Finland

THIRD ANGLE PROJECTION:

DRAWING TITLE  
**STRADA-2X2-ME-WIDE1**

This drawing is the property of LEDiL Oy. It may not be reproduced, copied or communicated without a written agreement with LEDiL Oy.

SIZE	PART NUMBER
A4	C14164

SCALE	1:1	WEIGHT	-	SHEET	1/1
-------	-----	--------	---	-------	-----

#### PHOTOMETRIC DATA (MEASURED):



LED XD16  
 FWHM Asymmetric  
 Efficiency 94 %  
 Peak intensity 1.400 cd/lm  
 Required components:

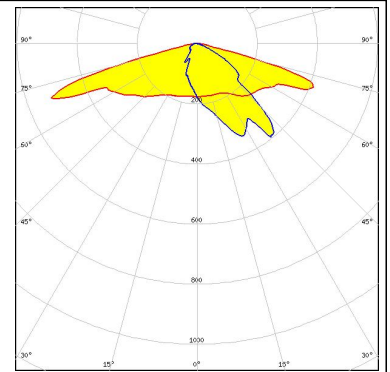

LED XD16 2x2 cluster  
 FWHM Asymmetric  
 Efficiency 94 %  
 Peak intensity 0.700 cd/lm  
 Required components:

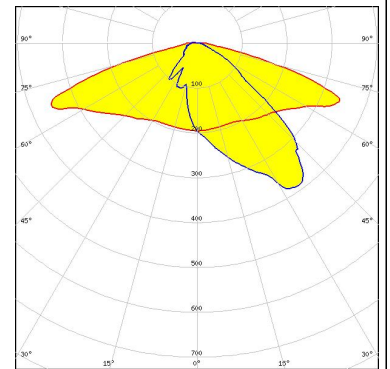
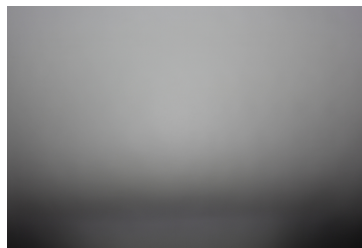

LED XP-G  
 FWHM Asymmetric  
 Efficiency 86 %  
 Peak intensity 0.950 cd/lm  
 Required components:  
 Undefined Manufacturer: Protective Plate, Glass

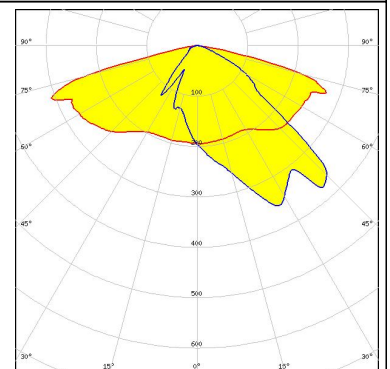

LED XP-G2  
 FWHM Asymmetric  
 Efficiency 83 %  
 Peak intensity 0.860 cd/lm  
 Required components:  
 Undefined Manufacturer: Protective Plate, Glass

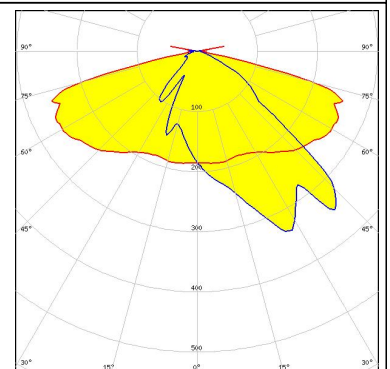

#### PHOTOMETRIC DATA (MEASURED):



LED XP-G3  
FWHM Asymmetric  
Efficiency 94 %  
Peak intensity 1.000 cd/lm  
Required components:

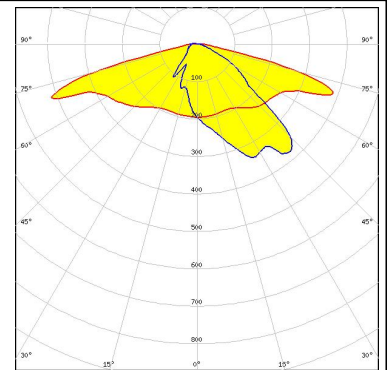

LED XP-L  
FWHM Asymmetric  
Efficiency 83 %  
Peak intensity 0.660 cd/lm  
Required components:  
Undefined Manufacturer: Protective Plate, Glass



LED XP-L2  
FWHM Asymmetric  
Efficiency 85 %  
Peak intensity 0.600 cd/lm  
Required components:

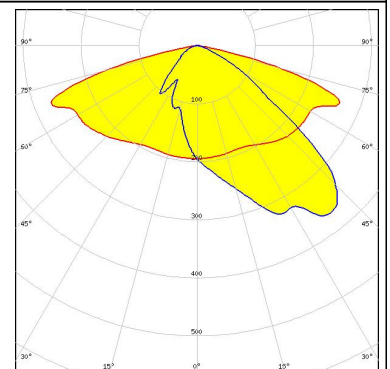

LED H35C1 (LEMWA33)  
FWHM Asymmetric  
Efficiency 86 %  
Peak intensity 0.820 cd/lm  
Required components:

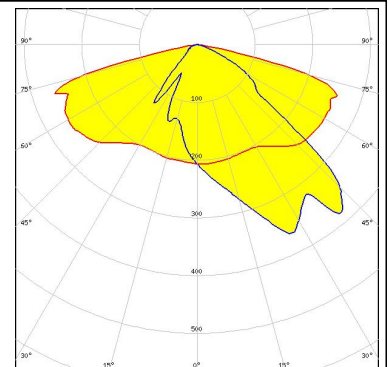

#### PHOTOMETRIC DATA (MEASURED):

#### LUMILEDS

LED LUXEON TX

FWHM Asymmetric

Efficiency 84 %

Peak intensity 0.880 cd/lm

Required components:

Undefined Manufacturer: Protective Plate, Glass

#### LUMILEDS

LED LUXEON V

FWHM Asymmetric

Efficiency 94 %

Peak intensity 0.770 cd/lm

Required components:

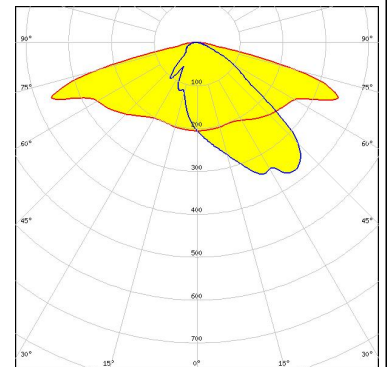

#### NICHIA

LED NVSW3x9A

FWHM Asymmetric

Efficiency 86 %

Peak intensity 0.780 cd/lm

Required components:

Undefined Manufacturer: Protective Plate, Glass

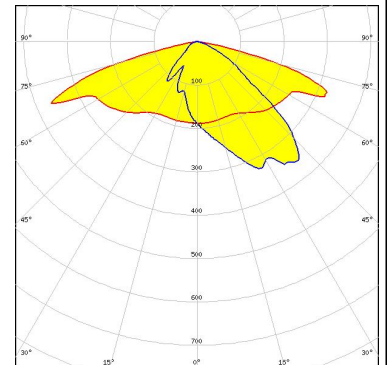
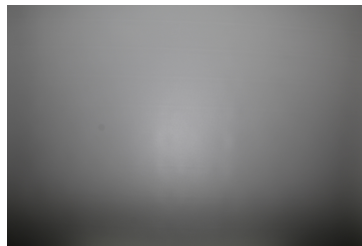

#### OSRAM

LED PrevaLED Brick DC 2x8

FWHM Asymmetric

Efficiency 86 %

Peak intensity 0.970 cd/lm

Required components:

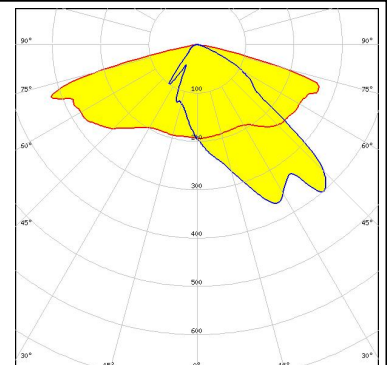

#### PHOTOMETRIC DATA (MEASURED):

**OSRAM**  
Opto Semiconductors

LED Duris S8  
FWHM Asymmetric  
Efficiency 94 %  
Peak intensity 0.620 cd/lm  
Required components:

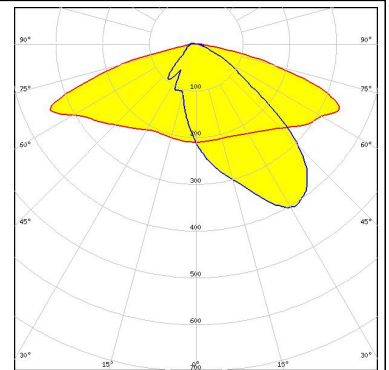

**OSRAM**  
Opto Semiconductors

LED Oslon Square Gen3  
FWHM Asymmetric  
Efficiency 86 %  
Peak intensity 0.970 cd/lm  
Required components:

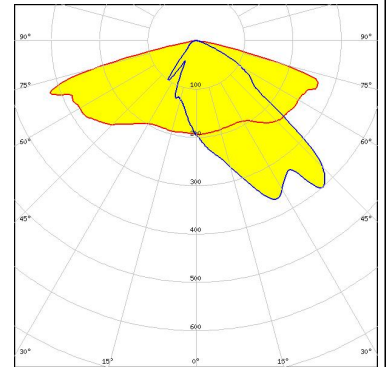

**OSRAM**  
Opto Semiconductors

LED Oslon Square PC  
FWHM Asymmetric  
Efficiency 84 %  
Peak intensity 0.900 cd/lm  
Required components:  
Undefined Manufacturer: Protective Plate, Glass

**PHILIPS**

LED Fortimo FastFlex LED board 2x8 DA G4  
FWHM Asymmetric  
Efficiency 86 %  
Peak intensity 0.820 cd/lm  
Required components:  
Undefined Manufacturer: Protective Plate, Glass

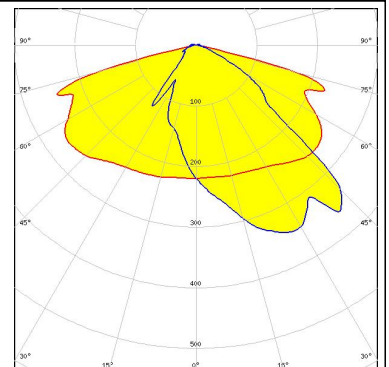

#### PHOTOMETRIC DATA (MEASURED):

#### PHILIPS

LED Fortimo FastFlex LED board 2x8 DAX G4  
FWHM Asymmetric  
Efficiency 94 %  
Peak intensity 1.000 cd/lm  
Required components:

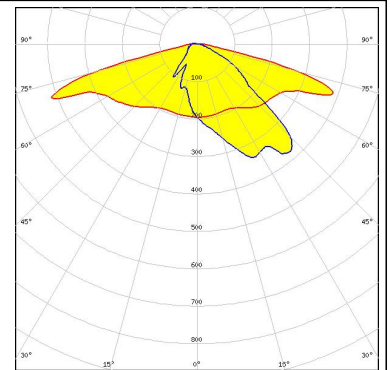

#### SAMSUNG

LED LH351B  
FWHM Asymmetric  
Efficiency 94 %  
Peak intensity 0.920 cd/lm  
Required components:

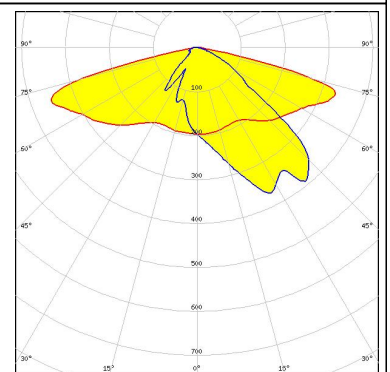

#### SAMSUNG

LED LH351B  
FWHM Asymmetric  
Efficiency 87 %  
Peak intensity 0.740 cd/lm  
Required components:  
Undefined Manufacturer: Protective Plate, Glass

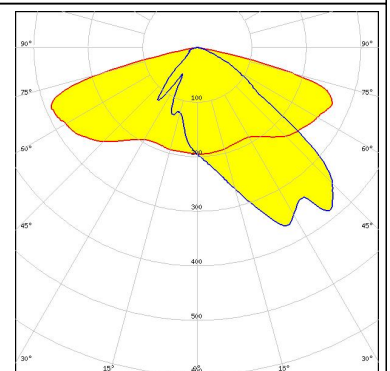

SEOUL SEMICONDUCTOR

LED Z8Y22  
FWHM Asymmetric  
Efficiency 94 %  
Peak intensity 1.100 cd/lm  
Required components:

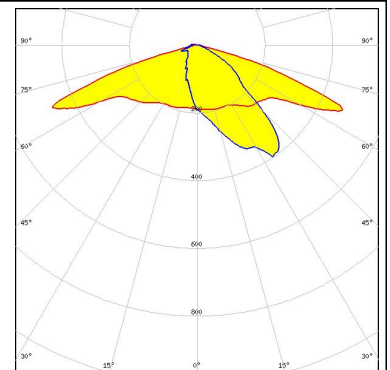

#### PHOTOMETRIC DATA (MEASURED):

#### TOSHIBA

Leading Innovation >>>

LED TL1L4  
 FWHM Asymmetric  
 Efficiency 83 %  
 Peak intensity 0.880 cd/lm  
 Required components:

Undefined Manufacturer: Protective Plate, Glass

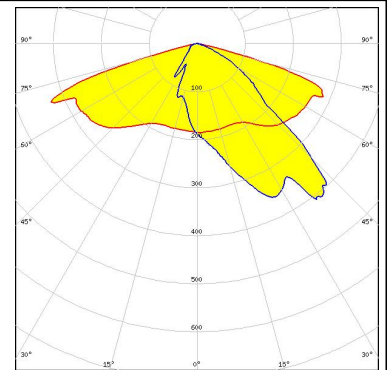

#### TRIDONIC

LED RLE G1 49x121mm 2000lm xxx EXC OTD  
 FWHM Asymmetric  
 Efficiency 94 %  
 Peak intensity 1.200 cd/lm  
 Required components:

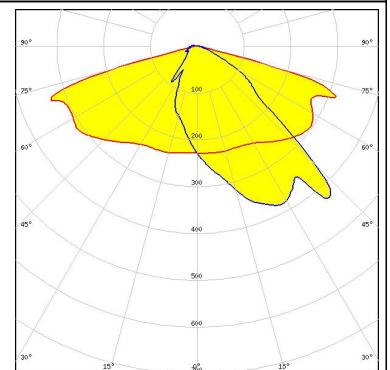

#### TRIDONIC

LED RLE G1 49x133mm 2000lm xxx EXC OTD  
 FWHM Asymmetric  
 Efficiency 94 %  
 Peak intensity 1.200 cd/lm  
 Required components:

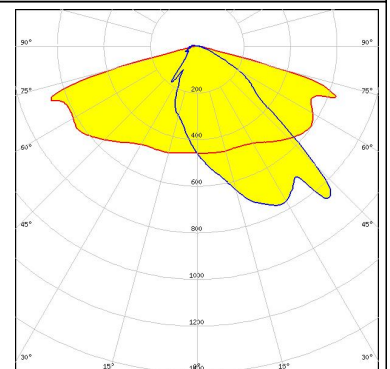

#### TRIDONIC

LED RLE G1 49x223mm 4000lm xxx EXC OTD  
 FWHM Asymmetric  
 Efficiency 94 %  
 Peak intensity 1.200 cd/lm  
 Required components:

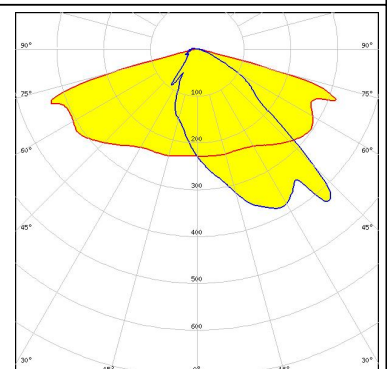

#### PHOTOMETRIC DATA (MEASURED):

#### TRIDONIC

LED RLE G1 49x245mm 4000lm xxx EXC OTD

FWHM Asymmetric

Efficiency 94 %

Peak intensity 1.200 cd/lm

Required components:

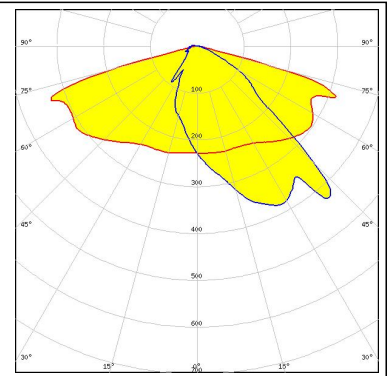

#### PHOTOMETRIC DATA (SIMULATED):



LED XHP35 HD  
FWHM Asymmetric  
Efficiency 94 %  
Peak intensity 0.550 cd/lm  
Required components:

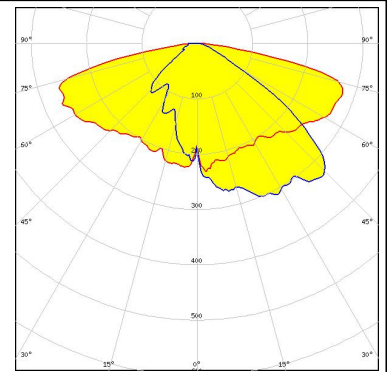

LED XT-E  
FWHM Asymmetric  
Efficiency 84 %  
Peak intensity cd/lm  
Required components:  
Undefined Manufacturer: Protective Plate, Glass

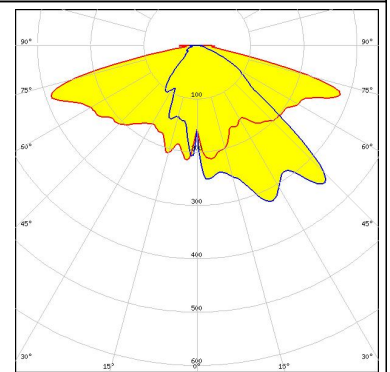

LED LUXEON 5050  
FWHM Asymmetric  
Efficiency 86 %  
Peak intensity 0.520 cd/lm  
Required components:  
Undefined Manufacturer: Protective Plate, Glass

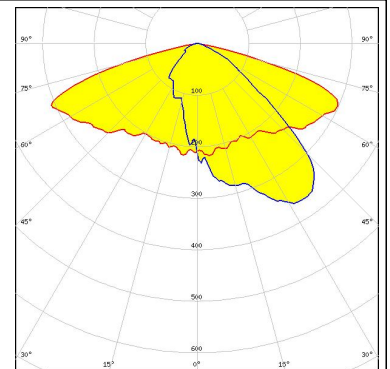

LED LUXEON 5050  
FWHM Asymmetric  
Efficiency 94 %  
Peak intensity 0.650 cd/lm  
Required components:

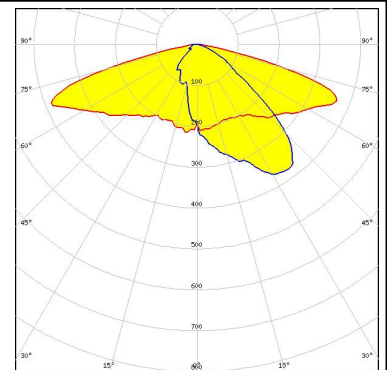

#### PHOTOMETRIC DATA (SIMULATED):



LED LUXEON T  
FWHM Asymmetric  
Efficiency 84 %  
Peak intensity cd/lm  
Required components:  
Undefined Manufacturer: Protective Plate, Glass



LED NVSW3x9A  
FWHM Asymmetric  
Efficiency 93 %  
Peak intensity 0.850 cd/lm  
Required components:

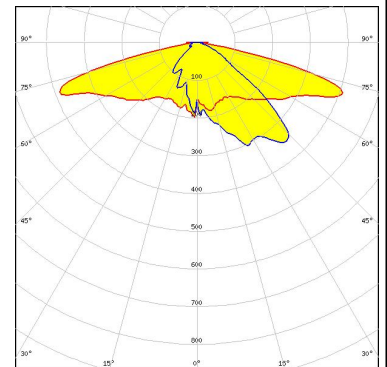

LED NVSxx19B/NVSxx19C  
FWHM Asymmetric  
Efficiency 94 %  
Peak intensity 0.860 cd/lm  
Required components:

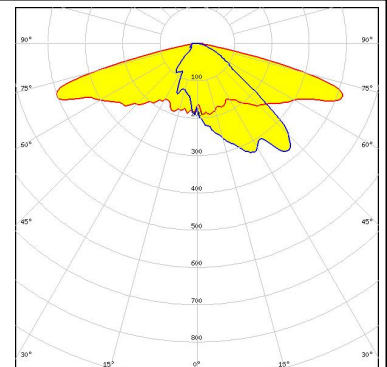

LED OSCONIQ P 3737 (2W version)  
FWHM Asymmetric  
Efficiency 94 %  
Peak intensity 0.900 cd/lm  
Required components:

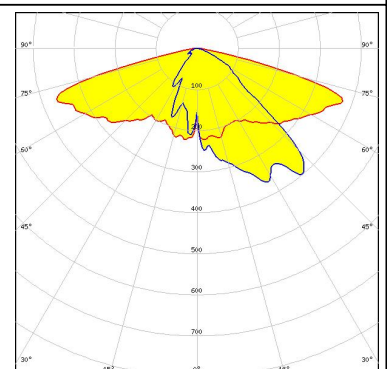

#### PHOTOMETRIC DATA (SIMULATED):

#### OSRAM Opto Semiconductors

LED                   OSCONIQ P 3737 (3W version)  
FWHM                Asymmetric  
Efficiency            94 %  
Peak intensity       0.720 cd/lm  
Required components:

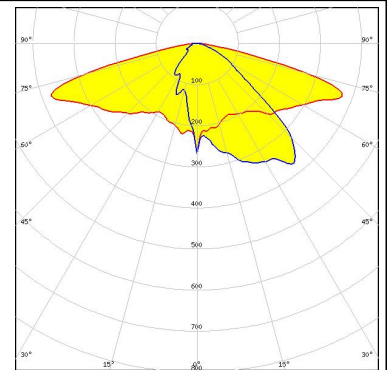

#### SAMSUNG

LED                   LH351D  
FWHM                Asymmetric  
Efficiency            76 %  
Peak intensity       0.440 cd/lm  
Required components:  
  Undefined Manufacturer: Protective Plate, Glass

#### GENERAL INFORMATION:

NOTE: The typical beam angle will be changed by different color, chip size and chip position tolerance. The typical total beam angle is the full angle measured where the luminous intensity is half of the peak value.

#### MATERIALS:

As part of our continuous research and improvement processes, and to ensure the best possible quality and availability of our products, LEDiL reserves the right to change material grades without notice.

#### PRODUCT DATA USER AGREEMENT AND DISCLAIMER:

The measured data in the provided downloadable LEDiL Product Datasheets and Mechanical 2D-Drawings is rounded and provided as reference for planning. LEDiL Oy's optical specifications have been verified by conducting performance testing of the products in accordance with the company's quality system. The reported data are averaged results of multiple measurements with typical variation. LEDiL Oy reserves the right to without prior notification make changes and improvements to its products.

LEDiL Oy assumes neither warranty, nor guarantee nor any other liability of any kind for the contents and correctness of the provided data. The provided data has been generated with highest diligence but the provided data may in reality not represent the complete possible variation range of all intrinsic parameters. Therefore, in certain cases a deviation from the provided data could occur.

LEDiL Oy reserves the right to undertake technical changes of its products without further notification which could lead to changes in the provided data. LEDiL Oy assumes no liability of any kind for the possible deviation from any provided data or any other damage resulting from the usage of the provided data.

The user agrees to this disclaimer and user agreement with the download or usage of the provided files.

#### LEDiL Oy

Joensuunkatu 13  
FI-24240 SALO  
Finland

#### LEDiL Inc.

228 West Page Street  
Suite D  
Sycamore IL 60178  
USA

#### Local sales and technical support

[www.ledil.com/  
where\\_to\\_buy](http://www.ledil.com/where_to_buy)

#### Shipping locations

Salo, Finland  
Hong Kong, China

#### Distribution Partners

[www.ledil.com/  
where\\_to\\_buy](http://www.ledil.com/where_to_buy)