

EMERALD-A

Asymmetric beam

TECHNICAL SPECIFICATIONS:

Dimensions	Ø 21.6 mm
Height	6.9 mm
Fastening	glue, pin
Colour	clear
Box size	480 x 280 x 300 mm
Box weight	4.6 kg
Quantity in Box	2016 pcs
ROHS compliant	yes ⓘ



MATERIAL SPECIFICATIONS:

Component	Type	Material	Colour
EMERALD-A	Lens	PMMA	clear

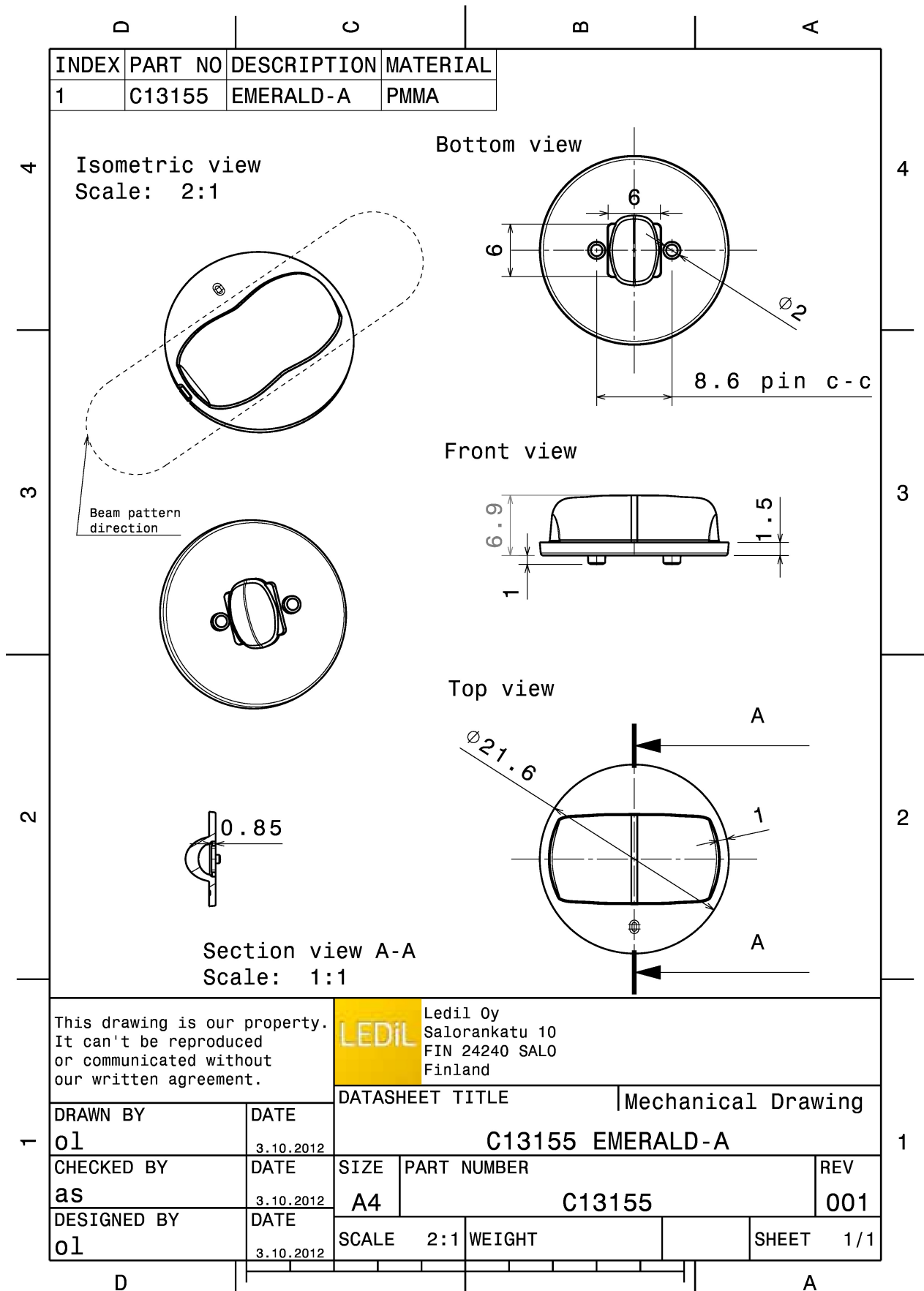

PHOTOMETRIC DATA (MEASURED):



LED XB-D
 FWHM 157.0 + 62.0°
 Efficiency 90 %
 Peak intensity 2.000 cd/lm
 Required components:

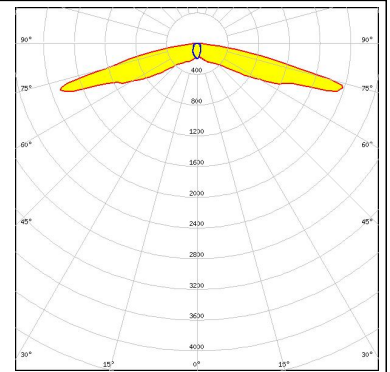

LED XM-L
 FWHM 157.0 + 83.0°
 Efficiency 94 %
 Peak intensity 1.100 cd/lm
 Required components:

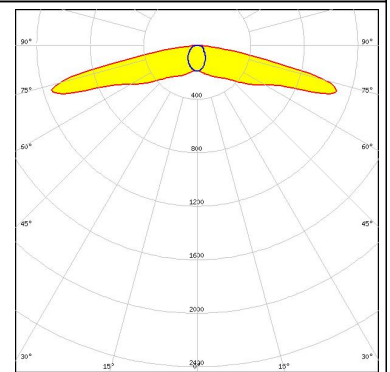

LED XM-L2
 FWHM 169.0 + 73.0°
 Efficiency 94 %
 Peak intensity 1.100 cd/lm
 Required components:

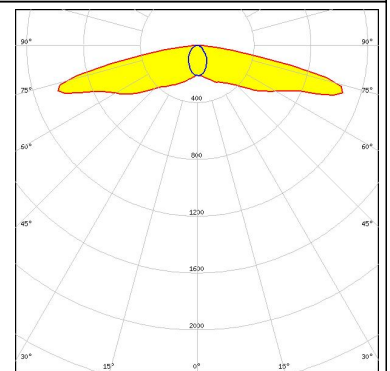
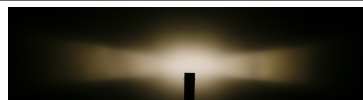

LED XP-E
 FWHM 158.0 + 73.0°
 Efficiency 93 %
 Peak intensity 2.300 cd/lm
 Required components:

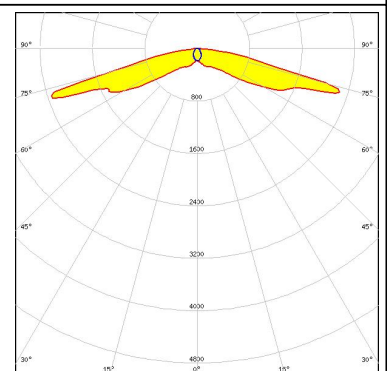

PHOTOMETRIC DATA (MEASURED):



LED XP-E2
FWHM 156.0 + 72.0°
Efficiency 93 %
Peak intensity 2.500 cd/lm
Required components:

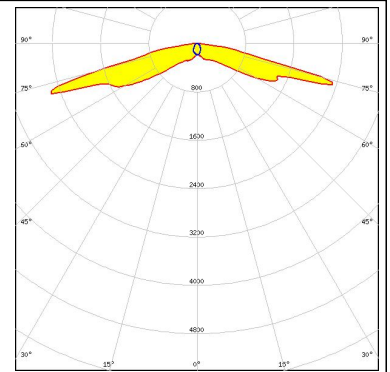

LED XP-G
FWHM 159.0 + 79.0°
Efficiency 89 %
Peak intensity 1.600 cd/lm
Required components:

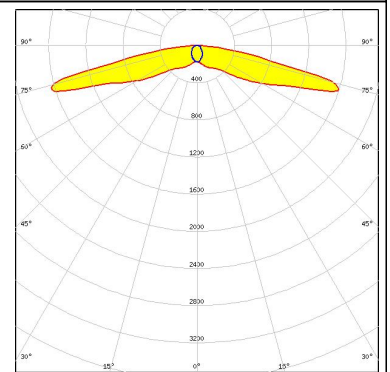

LED XP-G2
FWHM 158.0 + 79.0°
Efficiency 94 %
Peak intensity 1.800 cd/lm
Required components:

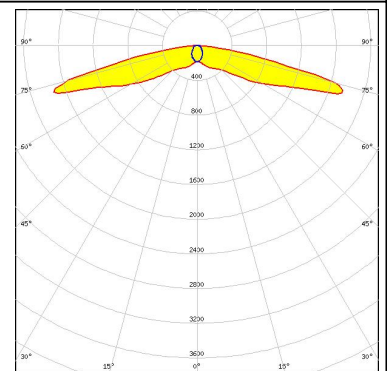

LED XT-E
FWHM 157.0 + 61.0°
Efficiency 89 %
Peak intensity 1.800 cd/lm
Required components:

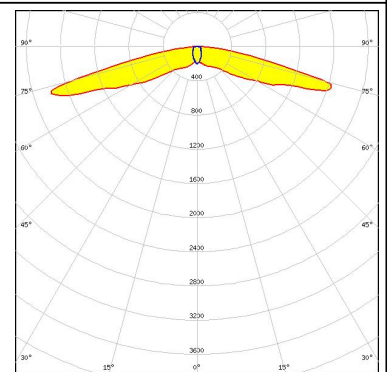

PHOTOMETRIC DATA (MEASURED):

LG Innotek

LED H35B0 (LEMWA32)
FWHM 160.0 + 66.0°
Efficiency 94 %
Peak intensity 1.700 cd/lm
Required components:

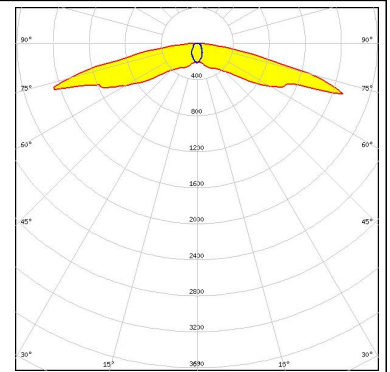

LG Innotek

LED H35C0 (LEMWA33)
FWHM 159.0 + 72.0°
Efficiency 91 %
Peak intensity 1.400 cd/lm
Required components:

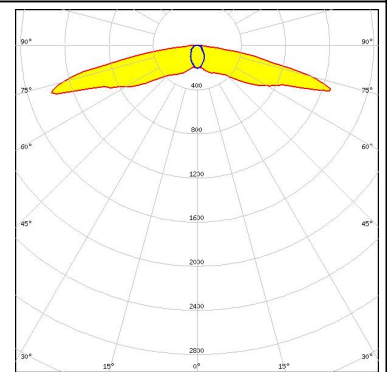

LUMILEDS

LED LUXEON A
FWHM 156.0 + 75.0°
Efficiency 92 %
Peak intensity 1.600 cd/lm
Required components:

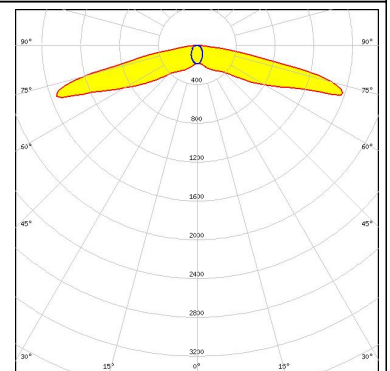

LUMILEDS

LED LUXEON R
FWHM 153.0 + 73.0°
Efficiency 92 %
Peak intensity 1.650 cd/lm
Required components:

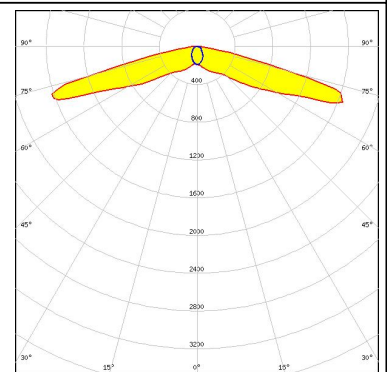

PHOTOMETRIC DATA (MEASURED):

LUMILEDS

LED LUXEON Rebel
FWHM 152.0 + 67.0°
Efficiency 92 %
Peak intensity 2.500 cd/lm
Required components:

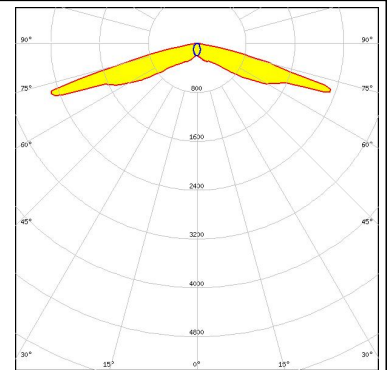

LUMILEDS

LED LUXEON Rebel ES
FWHM 153.0 + 74.0°
Efficiency 90 %
Peak intensity 1.700 cd/lm
Required components:

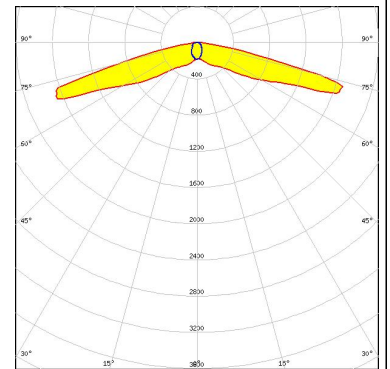

LUMILEDS

LED LUXEON T
FWHM 155.0 + 76.0°
Efficiency 93 %
Peak intensity 2.300 cd/lm
Required components:

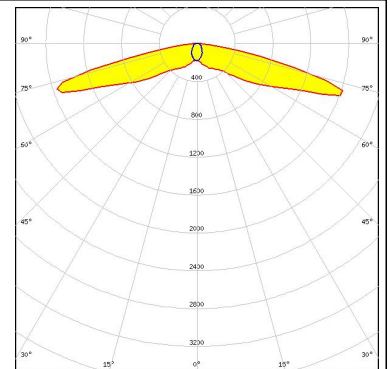

LUMILEDS

LED LUXEON TX
FWHM 156.0 + 73.0°
Efficiency 94 %
Peak intensity 1.690 cd/lm
Required components:

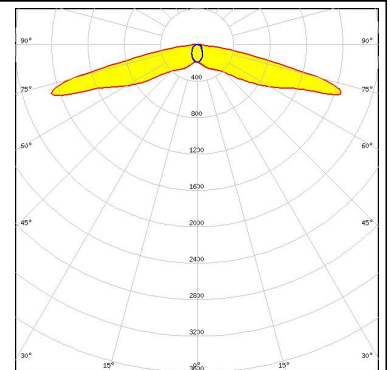

PHOTOMETRIC DATA (MEASURED):



LED NCSxx19A
 FWHM 151.0 + 65.0°
 Efficiency 92 %
 Peak intensity 2.200 cd/lm
 Required components:

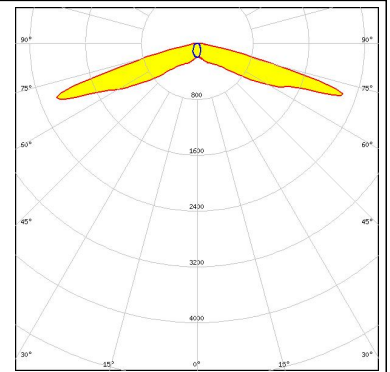

LED NVSxx19A
 FWHM 153.0 + 71.0°
 Efficiency 91 %
 Peak intensity 1.700 cd/lm
 Required components:

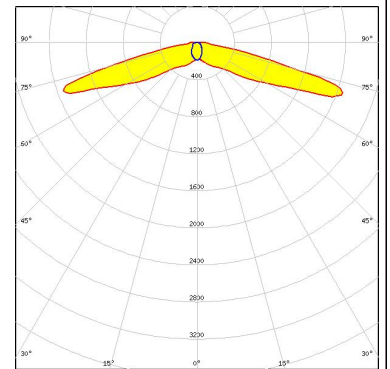

LED NVSxx19B/NVSxx19C
 FWHM 155.0 + 80.0°
 Efficiency 92 %
 Peak intensity 1.400 cd/lm
 Required components:

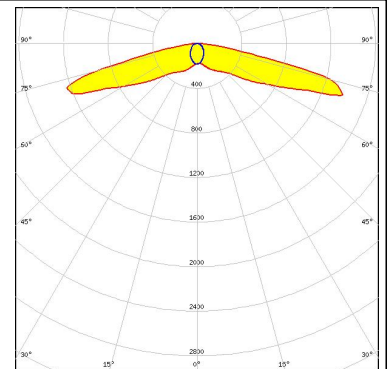

LED Oslon Square EC
 FWHM 156.0 + 80.0°
 Efficiency 93 %
 Peak intensity 1.700 cd/lm
 Required components:

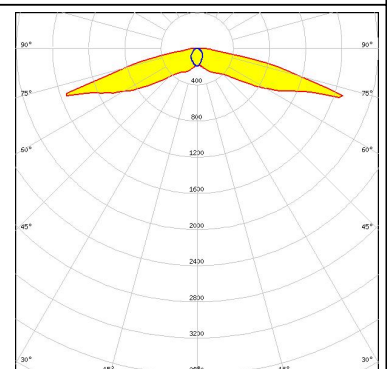

PHOTOMETRIC DATA (MEASURED):

OSRAM
Opto Semiconductors

LED Oslon Square PC
FWHM 156.0 + 83.0°
Efficiency 93 %
Peak intensity 1.700 cd/lm
Required components:

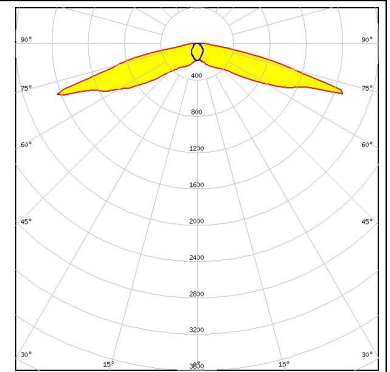

OSRAM
Opto Semiconductors

LED Oslon SSL 150
FWHM 157.0 + 86.0°
Efficiency 92 %
Peak intensity 2.900 cd/lm
Required components:

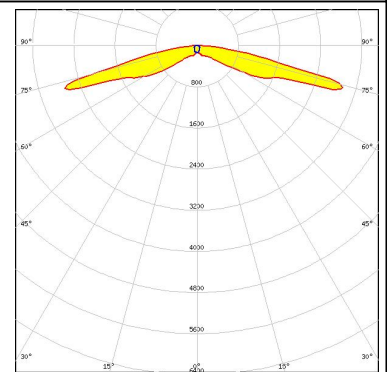

OSRAM
Opto Semiconductors

LED Oslon SSL 80
FWHM 147.0 + 52.0°
Efficiency 89 %
Peak intensity 1.900 cd/lm
Required components:

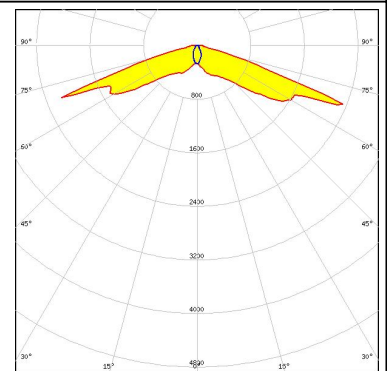

SAMSUNG

LED LH351Z
FWHM 154.0 + 76.0°
Efficiency 94 %
Peak intensity 1.700 cd/lm
Required components:

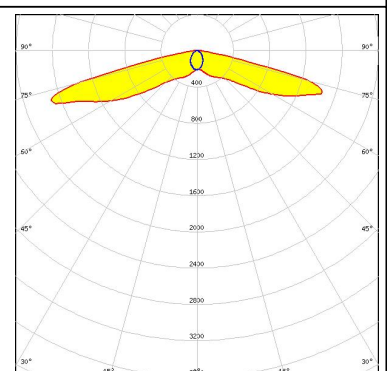

PHOTOMETRIC DATA (SIMULATED):

CREE 

LED XHP35 HD
FWHM 164.0 + 68.0°
Efficiency 91 %
Peak intensity 0.770 cd/lm
Required components:

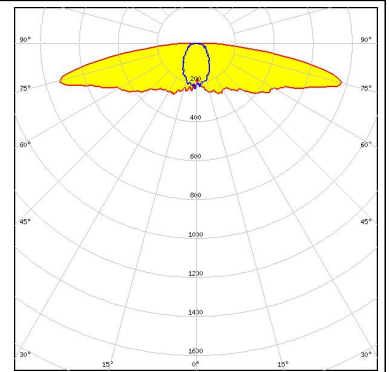

CREE 

LED XP-L HI
FWHM 159.0°
Efficiency 89 %
Peak intensity 1.300 cd/lm
Required components:

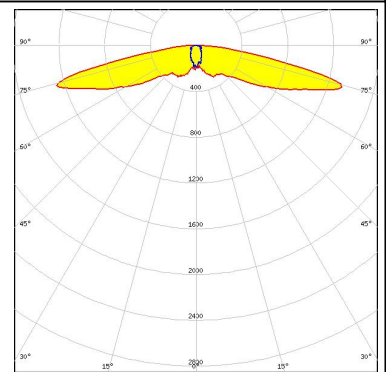

OSRAM
Opto Semiconductors

LED Oslon Square Gen3
FWHM 158.0 + 70.0°
Efficiency 93 %
Peak intensity 1.500 cd/lm
Required components:

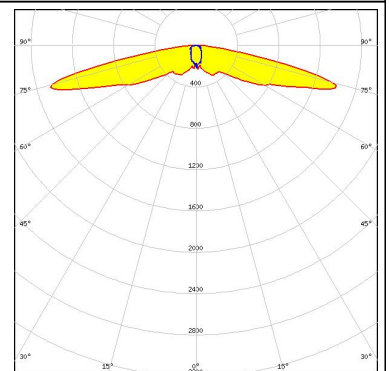

GENERAL INFORMATION:

NOTE: The typical beam angle will be changed by different color, chip size and chip position tolerance. The typical total beam angle is the full angle measured where the luminous intensity is half of the peak value.

MATERIALS:

As part of our continuous research and improvement processes, and to ensure the best possible quality and availability of our products, LEDiL reserves the right to change material grades without notice.

PRODUCT DATA USER AGREEMENT AND DISCLAIMER:

The measured data in the provided downloadable LEDiL Product Datasheets and Mechanical 2D-Drawings is rounded and provided as reference for planning. LEDiL Oy's optical specifications have been verified by conducting performance testing of the products in accordance with the company's quality system. The reported data are averaged results of multiple measurements with typical variation. LEDiL Oy reserves the right to without prior notification make changes and improvements to its products.

LEDiL Oy assumes neither warranty, nor guarantee nor any other liability of any kind for the contents and correctness of the provided data. The provided data has been generated with highest diligence but the provided data may in reality not represent the complete possible variation range of all intrinsic parameters. Therefore, in certain cases a deviation from the provided data could occur.

LEDiL Oy reserves the right to undertake technical changes of its products without further notification which could lead to changes in the provided data. LEDiL Oy assumes no liability of any kind for the possible deviation from any provided data or any other damage resulting from the usage of the provided data.

The user agrees to this disclaimer and user agreement with the download or usage of the provided files.

LEDiL Oy

Joensuunkatu 13
FI-24240 SALO
Finland

LEDiL Inc.

228 West Page Street
Suite D
Sycamore IL 60178
USA

Local sales and technical support

[www.ledil.com/
where_to_buy](http://www.ledil.com/where_to_buy)

Shipping locations

Salo, Finland
Hong Kong, China

Distribution Partners

[www.ledil.com/
where_to_buy](http://www.ledil.com/where_to_buy)