

MIRELLA-50-S

~15° spot beam

TECHNICAL SPECIFICATIONS:

| | |
|-----------------|--------------------|
| Dimensions | Ø 49.9 mm |
| Height | 24 mm |
| Fastening | glue |
| Colour | metal |
| Box size | 480 x 280 x 300 mm |
| Box weight | 3 kg |
| Quantity in Box | 336 pcs |
| ROHS compliant | yes ⓘ |



MATERIAL SPECIFICATIONS:

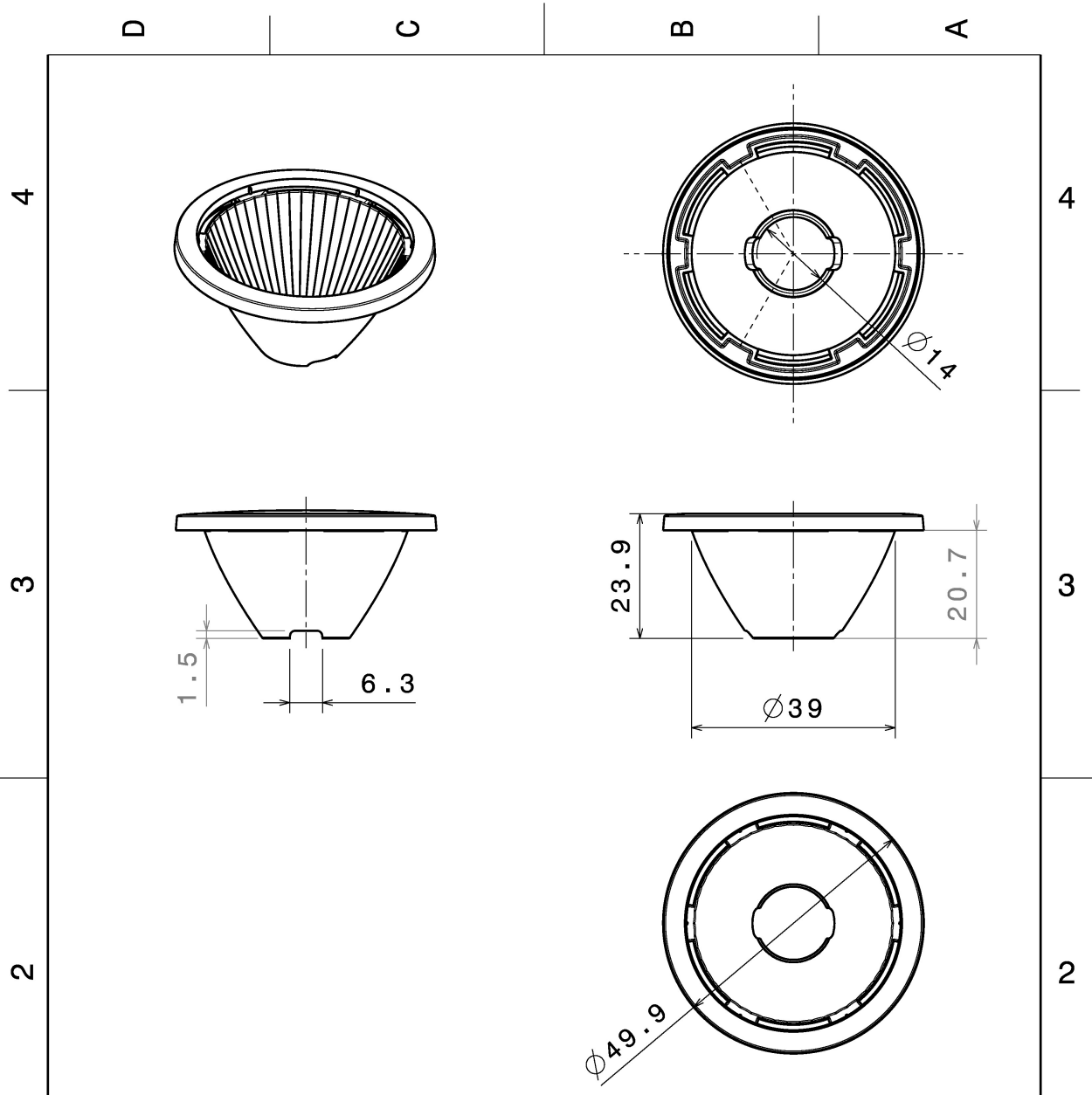

| Component | Type | Material | Colour | Coating |
|--------------|-----------|----------|--------|---------|
| MIRELLA-50-S | Reflector | PC | metal | lacquer |



Material: PC, metal plated

| | | | |
|---|--------------------|---|----------------|
| This drawing is our property. It can't be reproduced or communicated without our written agreement. | |  Ledil Oy Salorankatu 10 FIN-24240 SALO Finland | |
| DRAWING TITLE | | | |
| DRAWN BY pl | DATE 25.11.2011 | Datasheet Mirella reflector | |
| CHECKED BY | DATE | SIZE A4 | DRAWING NUMBER |
| DESIGNED BY pl | DATE 25.11.2011 | SCALE 1:1 | WEIGHT (g) |
| | | SHEET | 1/1 |

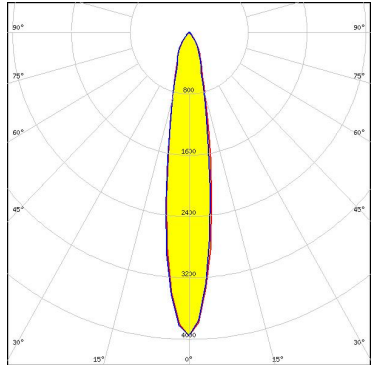
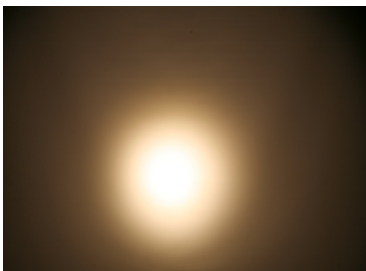
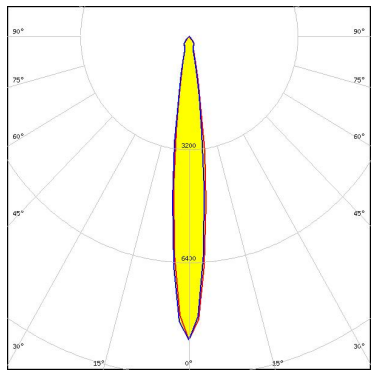
PHOTOMETRIC DATA (MEASURED):

| | | |
|--|--|--|
| <p>bridgelux.</p> <p>LED BXRA LS FWHM 18.0° Efficiency 83 % Peak intensity 4.000 cd/lm Required components: C12479_MIRELLA-DL</p> |  |  |
| <p>bridgelux.</p> <p>LED BXRA LS FWHM 13.0° Efficiency 89 % Peak intensity 8.600 cd/lm Required components:</p> |  |  |
| <p>bridgelux.</p> <p>LED BXRA LS FWHM 14.0° Efficiency 84 % Peak intensity 6.700 cd/lm Required components: C13333_MIRELLA-CL</p> |  | |
| <p>CITIZEN</p> <p>LED CLL01x FWHM 17.0° Efficiency 84 % Peak intensity 5.500 cd/lm Required components: C13333_MIRELLA-CL</p> |  | |

PHOTOMETRIC DATA (MEASURED):

CITIZEN

LED CLL01x
FWHM 20.0°
Efficiency %
Peak intensity cd/lm
Required components:
C12479_MIRELLA-DL



CITIZEN

LED CLL01x
FWHM 14.0°
Efficiency %
Peak intensity cd/lm
Required components:



CITIZEN

LED CLL02x/CLU02x (LES10)
FWHM 28.0°
Efficiency 82 %
Peak intensity 2.130 cd/lm
Required components:
C12479_MIRELLA-DL

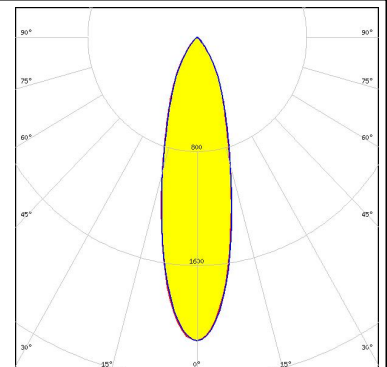
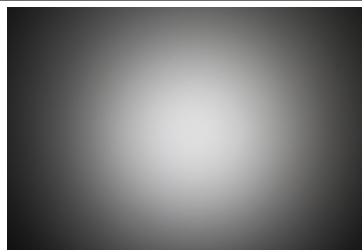

CITIZEN

LED CLL02x/CLU02x (LES10)
FWHM 32.0°
Efficiency 81 %
Peak intensity 1.800 cd/lm
Required components:
C13723_MIRELLA-RZL

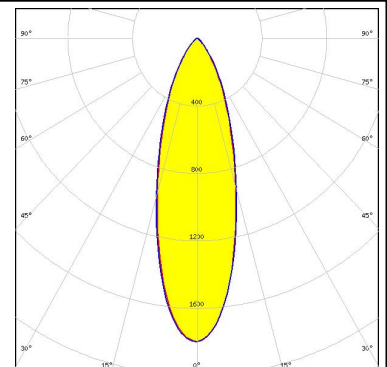
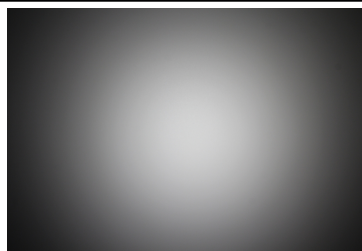

PHOTOMETRIC DATA (MEASURED):

CITIZEN

LED CLL02x/CLU02x (LES10)
FWHM 20.0°
Efficiency 93 %
Peak intensity cd/lm
Required components:



CITIZEN

LED CLL02x/CLU02x (LES10)
FWHM 19.0°
Efficiency 84 %
Peak intensity 3.600 cd/lm
Required components:
C13333_MIRELLA-CL



CITIZEN

LED CLU700/701
FWHM 26.0°
Efficiency 83 %
Peak intensity 2.300 cd/lm
Required components:
C13723_MIRELLA-RZL

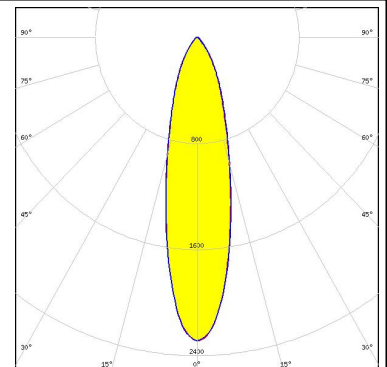
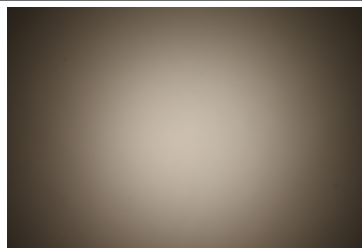

CITIZEN

LED CLU700/701
FWHM 15.0°
Efficiency 90 %
Peak intensity 6.200 cd/lm
Required components:

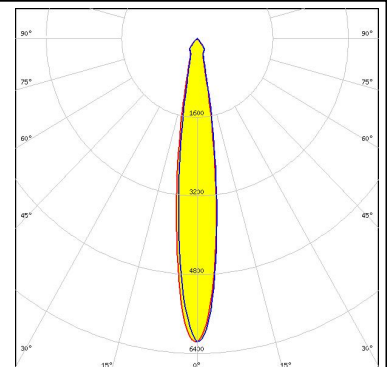

PHOTOMETRIC DATA (MEASURED):

CITIZEN

LED CLU700/701
FWHM 15.0°
Efficiency 85 %
Peak intensity 5.900 cd/lm
Required components:
C13333_MIRELLA-CL

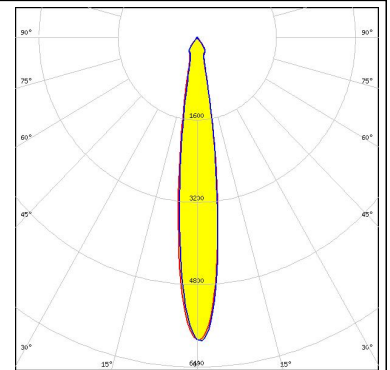

CITIZEN

LED CLU700/701
FWHM 21.0°
Efficiency 84 %
Peak intensity 3.100 cd/lm
Required components:
C12479_MIRELLA-DL

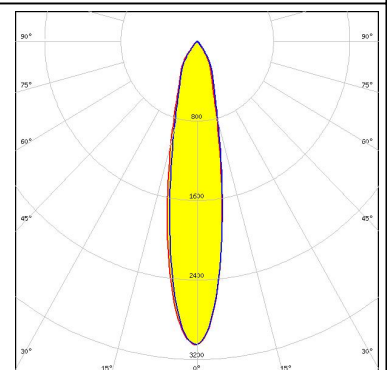
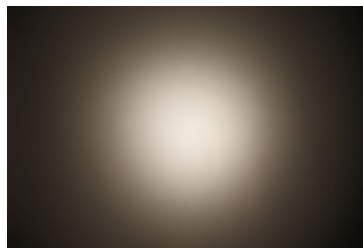

CITIZEN

LED CLU710/711
FWHM 26.0°
Efficiency 83 %
Peak intensity 2.100 cd/lm
Required components:
C12479_MIRELLA-DL

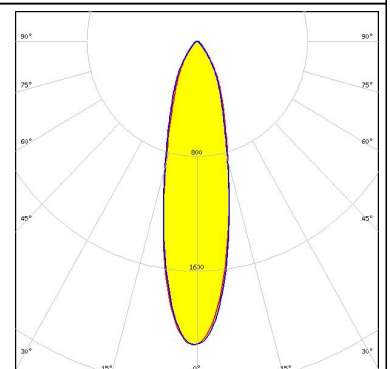
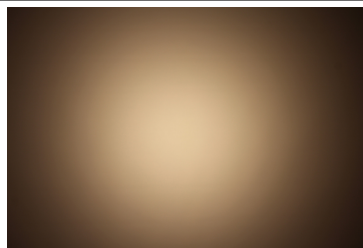

CITIZEN

LED CLU710/711
FWHM 20.0°
Efficiency 90 %
Peak intensity 3.700 cd/lm
Required components:

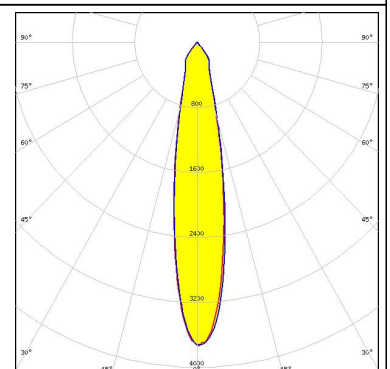
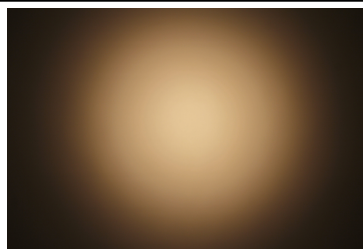

PHOTOMETRIC DATA (MEASURED):

CITIZEN

LED CLU710/711
FWHM 29.0°
Efficiency 83 %
Peak intensity 1.900 cd/lm
Required components:
C13723_MIRELLA-RZL

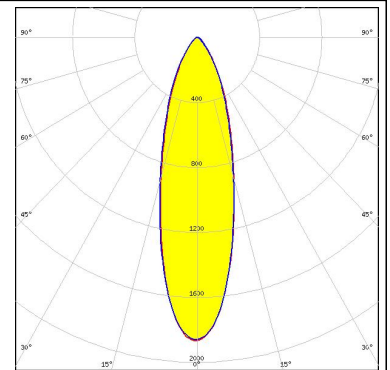
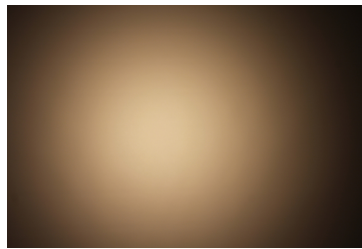

CITIZEN

LED CLU710/711
FWHM 20.0°
Efficiency 85 %
Peak intensity 3.400 cd/lm
Required components:
C13333_MIRELLA-CL

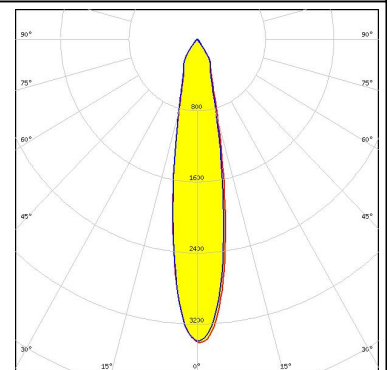
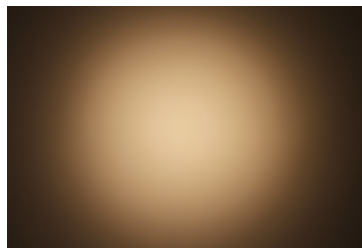

CITIZEN

LED CLU720/721
FWHM 32.0°
Efficiency 83 %
Peak intensity 1.700 cd/lm
Required components:
C13723_MIRELLA-RZL

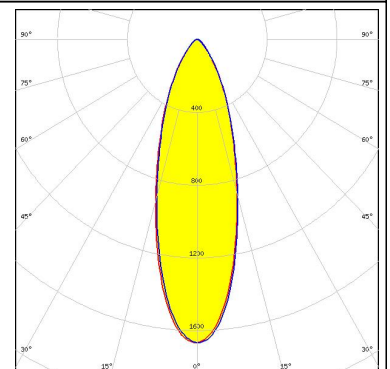
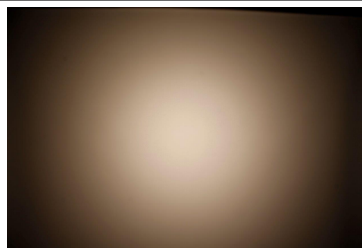

CITIZEN

LED CLU720/721
FWHM 25.0°
Efficiency 85 %
Peak intensity 2.500 cd/lm
Required components:
C13333_MIRELLA-CL

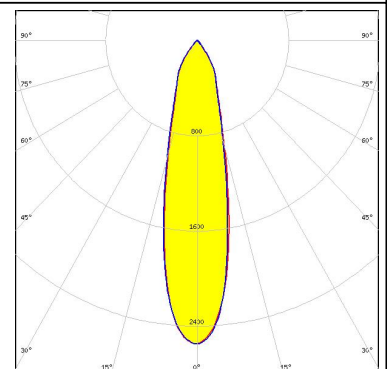
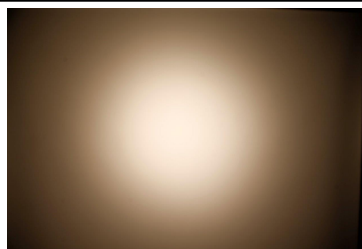

PHOTOMETRIC DATA (MEASURED):

CITIZEN

LED CLU720/721
FWHM 30.0°
Efficiency 82 %
Peak intensity 1.800 cd/lm
Required components:
C12479_MIRELLA-DL

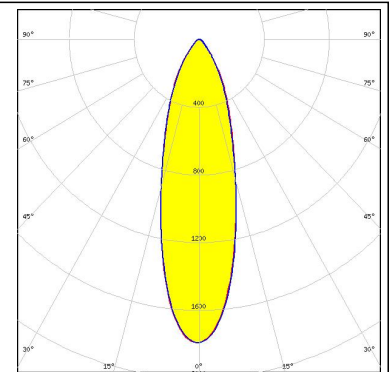
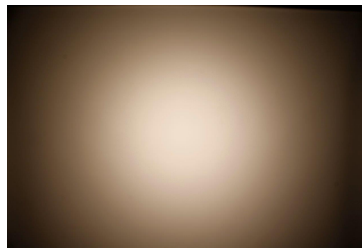

CITIZEN

LED CLU720/721
FWHM 24.0°
Efficiency 90 %
Peak intensity 2.400 cd/lm
Required components:

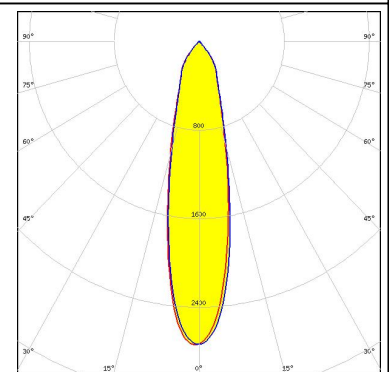
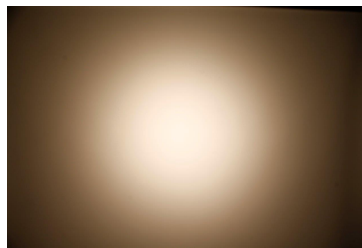

CREE 

LED CXA/B 13xx
FWHM 12.0°
Efficiency 87 %
Peak intensity 9.500 cd/lm
Required components:

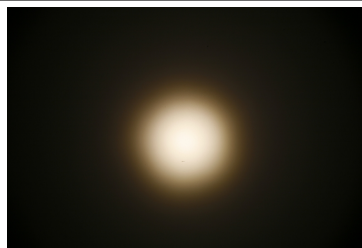

CREE 

LED CXA/B 13xx
FWHM 15.0°
Efficiency 81 %
Peak intensity 5.400 cd/lm
Required components:
C12479_MIRELLA-DL



PHOTOMETRIC DATA (MEASURED):



LED CXA/B 13xx
FWHM 12.0°
Efficiency 82 %
Peak intensity 8.500 cd/lm
Required components:
C13333_MIRELLA-CL

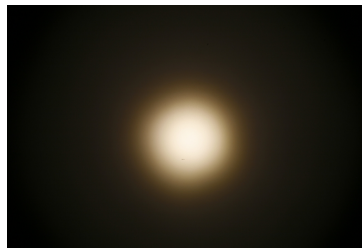

LED CXA/B 15xx
FWHM 19.0°
Efficiency 84 %
Peak intensity 4.300 cd/lm
Required components:
C13333_MIRELLA-CL



LED CXA/B 15xx
FWHM 16.0°
Efficiency 93 %
Peak intensity 5.100 cd/lm
Required components:

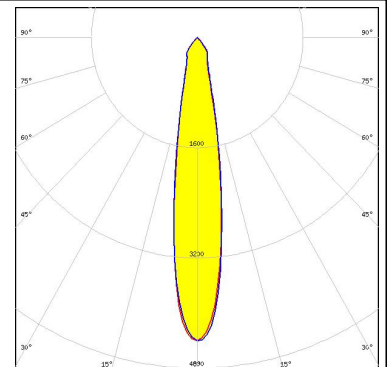

LED CXA/B 15xx
FWHM 20.0°
Efficiency 90 %
Peak intensity 3.100 cd/lm
Required components:
C12479_MIRELLA-DL

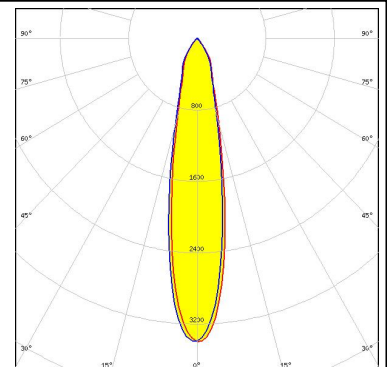

PHOTOMETRIC DATA (MEASURED):



LED CXA/B 1816 & CXA/B 1820 & CXA 1850
 FWHM 26.0°
 Efficiency 83 %
 Peak intensity 2.600 cd/lm
 Required components:
 C12479_MIRELLA-DL

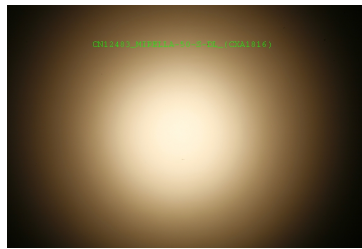

LED CXA/B 1816 & CXA/B 1820 & CXA 1850
 FWHM 25.0°
 Efficiency 83 %
 Peak intensity 2.900 cd/lm
 Required components:
 C13333_MIRELLA-CL

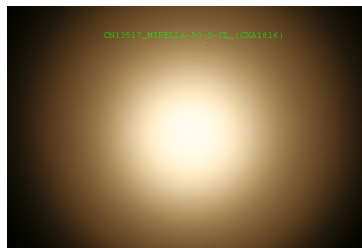

LED CXA/B 1816 & CXA/B 1820 & CXA 1850
 FWHM 23.0°
 Efficiency 89 %
 Peak intensity 3.200 cd/lm
 Required components:

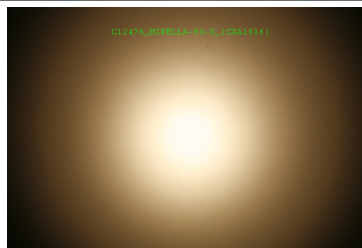

LED MHD-E/G
 FWHM 16.0°
 Efficiency 94 %
 Peak intensity 5.000 cd/lm
 Required components:

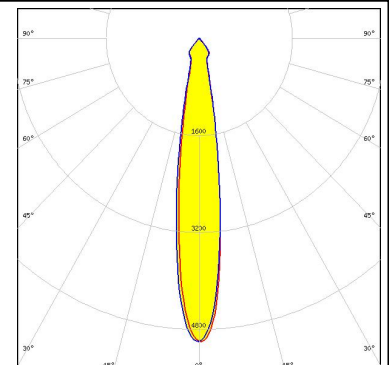

PHOTOMETRIC DATA (MEASURED):

CREE 

LED MHD-E/G
 FWHM 18.0°
 Efficiency 89 %
 Peak intensity 4.200 cd/lm
 Required components:
 C13333_MIRELLA-CL

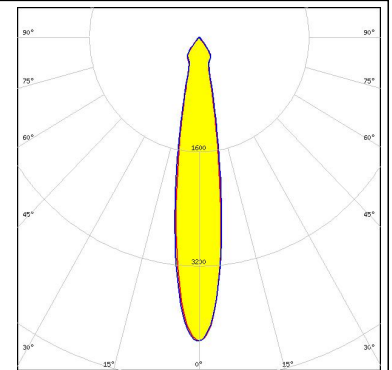

CREE 

LED MHD-E/G
 FWHM 20.0°
 Efficiency 88 %
 Peak intensity 3.300 cd/lm
 Required components:
 C12479_MIRELLA-DL

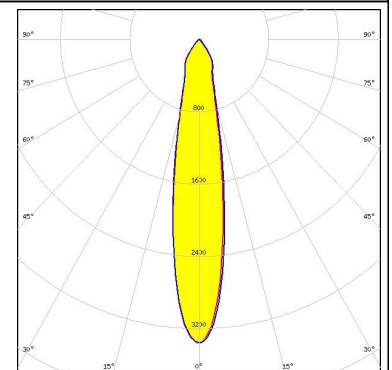
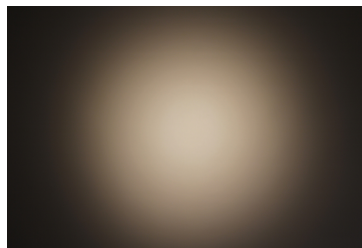

CREE 

LED MT-G2
 FWHM 17.0°
 Efficiency 92 %
 Peak intensity 5.500 cd/lm
 Required components:

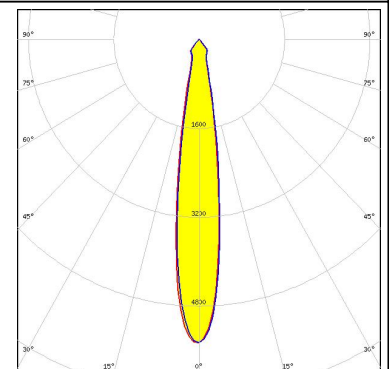

CREE 

LED MT-G2
 FWHM 18.0°
 Efficiency 85 %
 Peak intensity 4.700 cd/lm
 Required components:
 C13333_MIRELLA-CL



PHOTOMETRIC DATA (MEASURED):



LED MT-G2
FWHM 20.0°
Efficiency 85 %
Peak intensity 3.700 cd/lm
Required components:
C12479_MIRELLA-DL

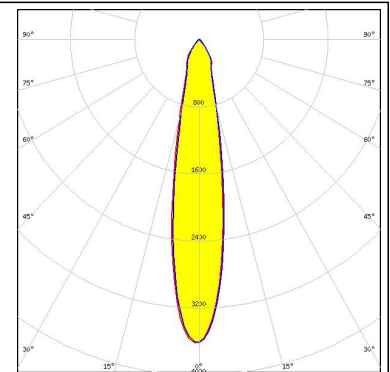

LED XHP50
FWHM 14.0°
Efficiency 92 %
Peak intensity 7.200 cd/lm
Required components:

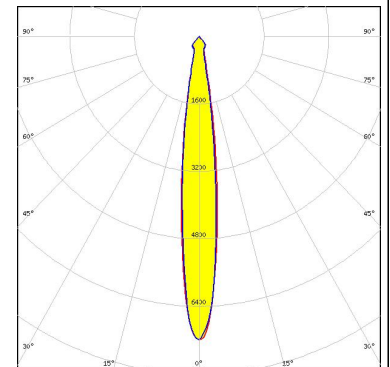
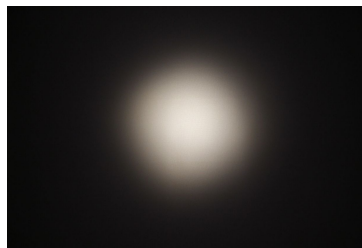

LED XHP50
FWHM 14.0°
Efficiency 86 %
Peak intensity 6.200 cd/lm
Required components:
C13333_MIRELLA-CL

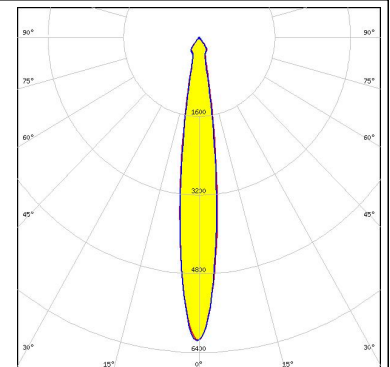
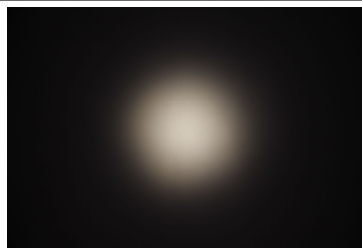

LED XHP50
FWHM 17.0°
Efficiency 85 %
Peak intensity 4.100 cd/lm
Required components:
C12479_MIRELLA-DL

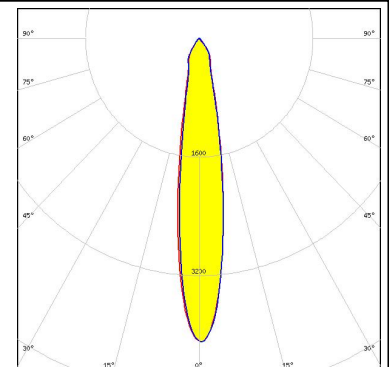

PHOTOMETRIC DATA (MEASURED):



LED XHP70
 FWHM 17.0°
 Efficiency 90 %
 Peak intensity 5.500 cd/lm
 Required components:

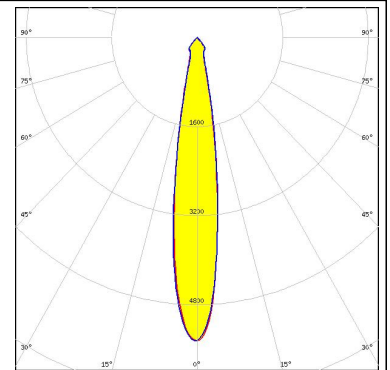

LED XHP70
 FWHM 18.0°
 Efficiency 86 %
 Peak intensity 4.800 cd/lm
 Required components:
 C13333_MIRELLA-CL

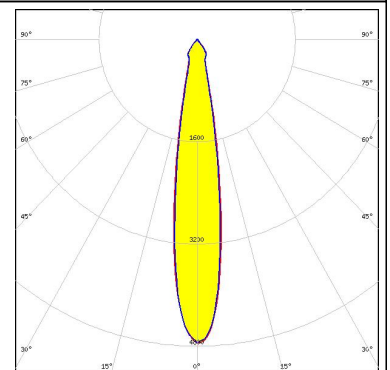

LED XHP70
 FWHM 19.0°
 Efficiency 86 %
 Peak intensity 4.000 cd/lm
 Required components:
 C12479_MIRELLA-DL

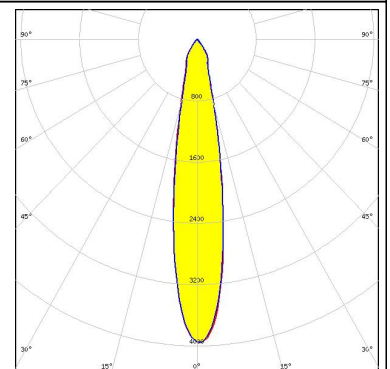
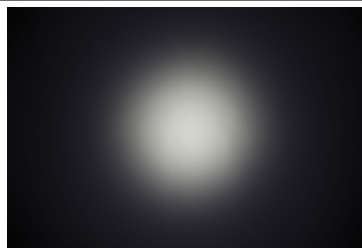

LED COB 4W
 FWHM 14.0°
 Efficiency 91 %
 Peak intensity 6.700 cd/lm
 Required components:



PHOTOMETRIC DATA (MEASURED):

LG Innotek

LED COB 4W
FWHM 15.0°
Efficiency 85 %
Peak intensity 6.300 cd/lm
Required components:
C13333_MIRELLA-CL

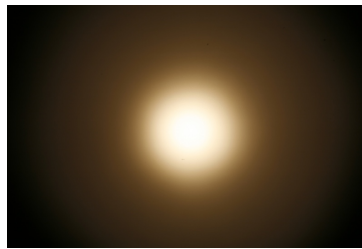

LG Innotek

LED COB 4W
FWHM 17.0°
Efficiency 86 %
Peak intensity 4.400 cd/lm
Required components:
C12479_MIRELLA-DL

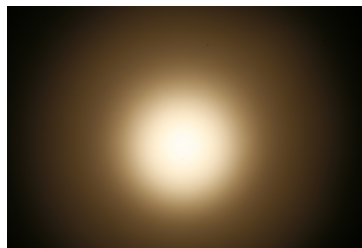

LUMILEDS

LED LUXEON CoB 1202/1203
FWHM 21.0°
Efficiency 86 %
Peak intensity 3.600 cd/lm
Required components:
C13333_MIRELLA-CL

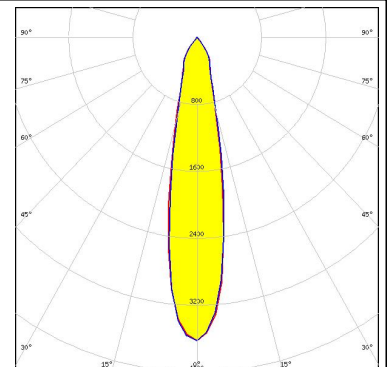
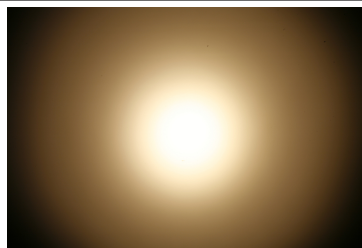



LUMILEDS

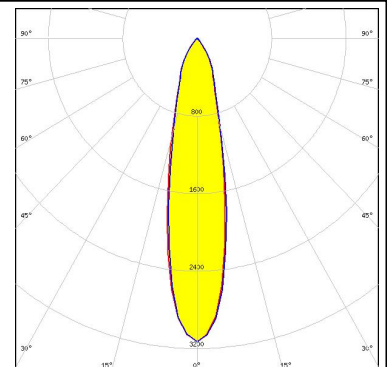
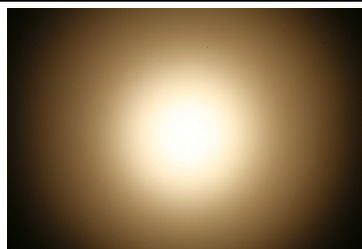

LED LUXEON CoB 1202/1203
FWHM 23.0°
Efficiency 85 %
Peak intensity 3.100 cd/lm
Required components:
C12479_MIRELLA-DL

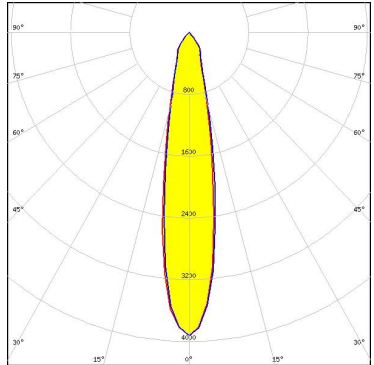

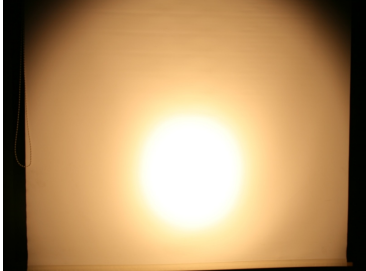
PHOTOMETRIC DATA (MEASURED):

| | | |
|---|--|---|
| <p>LUMILEDS</p> <p>LED LUXEON CoB 1202/1203</p> <p>FWHM 20.0°</p> <p>Efficiency 89 %</p> <p>Peak intensity 3.900 cd/lm</p> <p>Required components:</p> |  |  |
| <p>LUMILEDS</p> <p>LED LUXEON S1000</p> <p>FWHM 21.0°</p> <p>Efficiency %</p> <p>Peak intensity cd/lm</p> <p>Required components: C12479_MIRELLA-DL</p> |  | |
| <p>LUMILEDS</p> <p>LED LUXEON S1000</p> <p>FWHM 14.0°</p> <p>Efficiency 84 %</p> <p>Peak intensity 5.500 cd/lm</p> <p>Required components: C13333_MIRELLA-CL</p> |  | |
| <p>LUMILEDS</p> <p>LED LUXEON S1000</p> <p>FWHM 17.0°</p> <p>Efficiency %</p> <p>Peak intensity cd/lm</p> <p>Required components:</p> |  | |

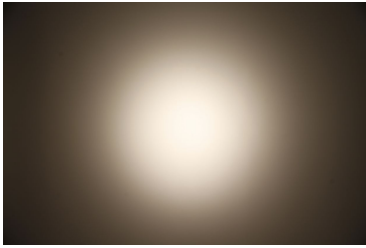
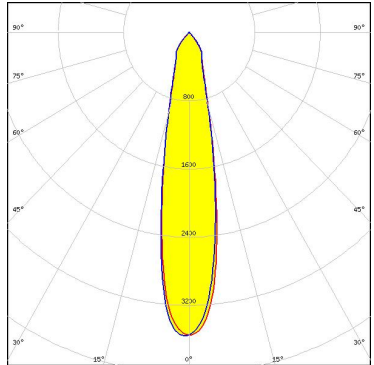
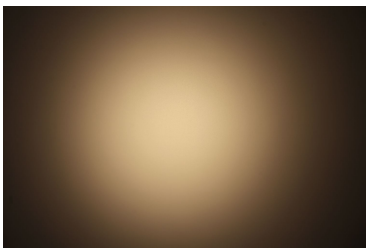
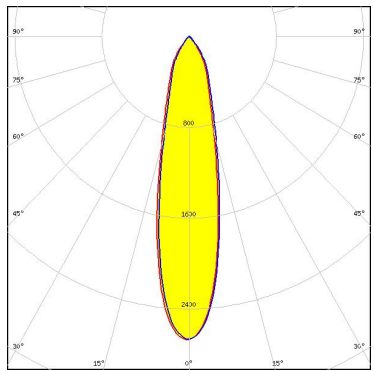
PHOTOMETRIC DATA (MEASURED):

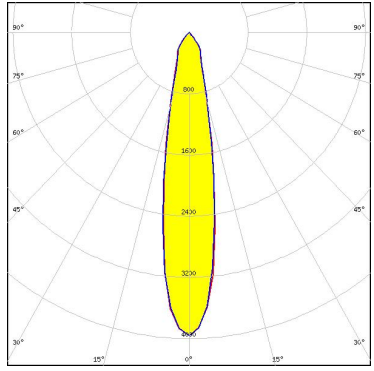
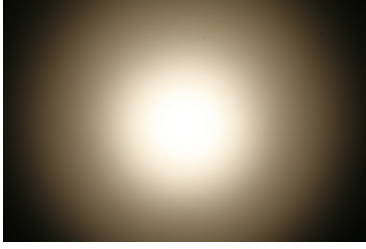
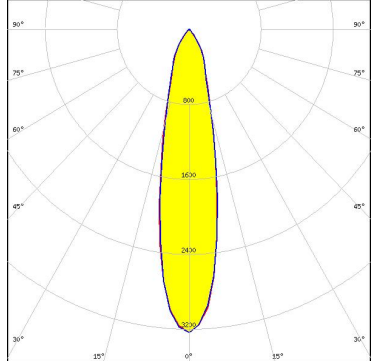
| | | |
|--|--|---|
| <p>LUMINUS</p> <p>LED CXM-9 FWHM 21.0° Efficiency 90 % Peak intensity 3.600 cd/lm Required components:</p> |  |  |
| <p>LUMINUS</p> <p>LED CXM-9 FWHM 24.0° Efficiency 84 % Peak intensity 2.700 cd/lm Required components: C12479_MIRELLA-DL</p> |  |  |
| <p>NICHIA</p> <p>LED COB L-Type (LES 9) FWHM 20.0° Efficiency 90 % Peak intensity 4.000 cd/lm Required components:</p> |  |  |
| <p>NICHIA</p> <p>LED COB L-Type (LES 9) FWHM 23.0° Efficiency 86 % Peak intensity 3.200 cd/lm Required components: C12479_MIRELLA-DL</p> |  |  |

PHOTOMETRIC DATA (MEASURED):



LED COB L-Type (LES 9)
 FWHM 22.0°
 Efficiency 87 %
 Peak intensity 3.700 cd/lm
 Required components:
 C13333_MIRELLA-CL

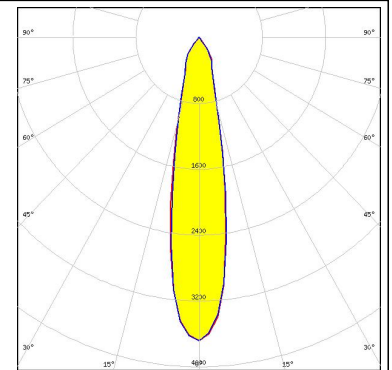
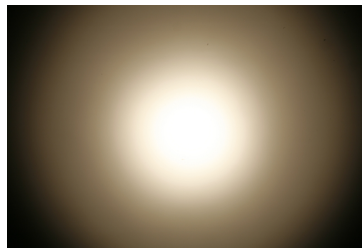

LED NFMW48xA
 FWHM 9.5°
 Efficiency 88 %
 Peak intensity 13.600 cd/lm
 Required components:

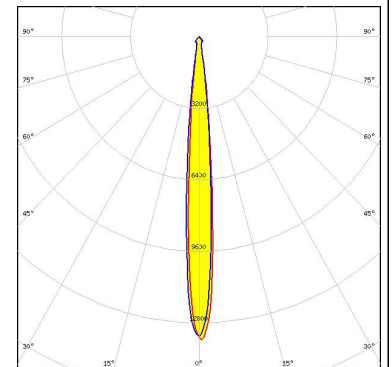

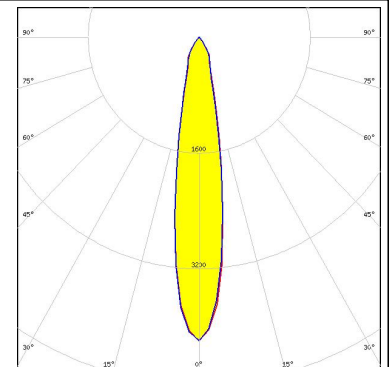

LED NSCxL036A
 FWHM 19.0°
 Efficiency 84 %
 Peak intensity 4.200 cd/lm
 Required components:
 C12479_MIRELLA-DL



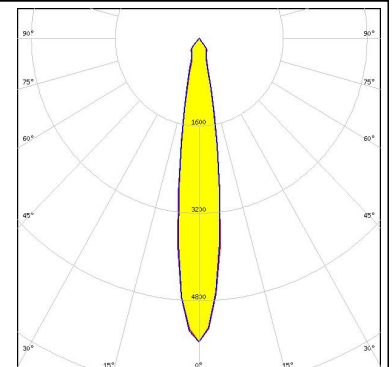

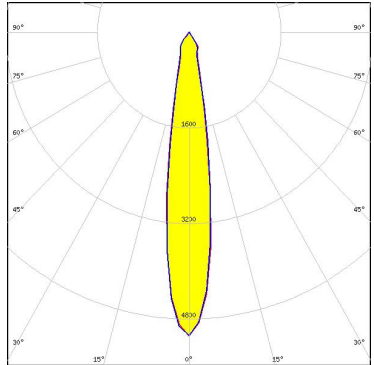
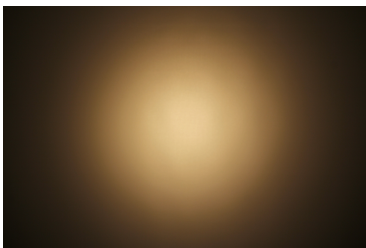

LED NSCxL036A
 FWHM 17.0°
 Efficiency 88 %
 Peak intensity 5.600 cd/lm
 Required components:





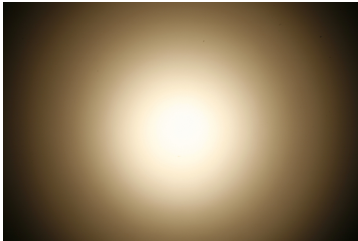
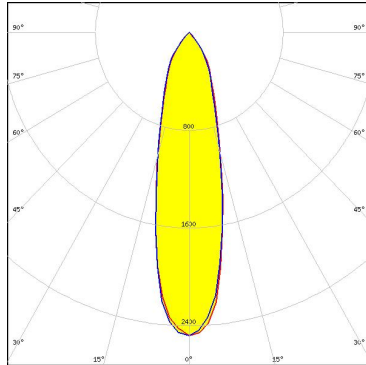
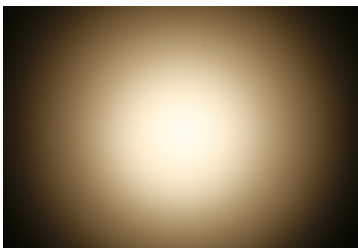
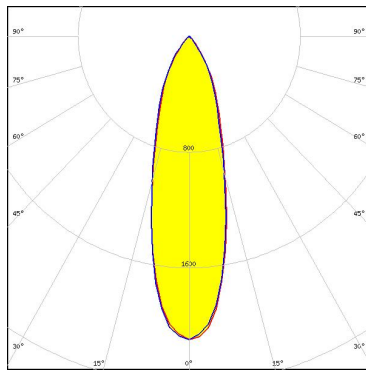

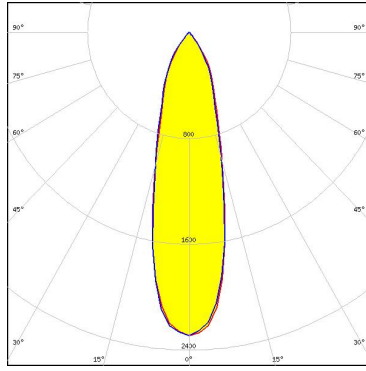

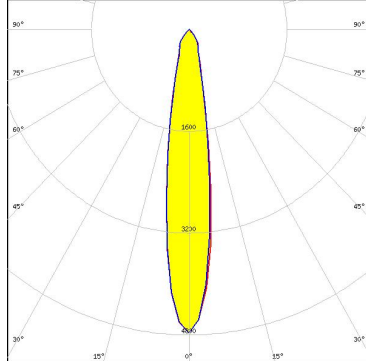

PHOTOMETRIC DATA (MEASURED):

| | | |
|--|--|---|
| <p>NICHIA</p> <p>LED NSCxL036A FWHM 17.0° Efficiency 84 % Peak intensity 5.000 cd/lm Required components: C13333_MIRELLA-CL</p> |  |  |
| <p>OSRAM Opto Semiconductors</p> <p>LED Duris S10 FWHM 20.0° Efficiency 81 % Peak intensity 3.400 cd/lm Required components: C12479_MIRELLA-DL</p> |  | |
| <p>OSRAM Opto Semiconductors</p> <p>LED Duris S10 FWHM 15.0° Efficiency 89 % Peak intensity 6.500 cd/lm Required components:</p> |  | |
| <p>OSRAM Opto Semiconductors</p> <p>LED Duris S10 FWHM 15.0° Efficiency 83 % Peak intensity 6.700 cd/lm Required components: C13333_MIRELLA-CL</p> |  | |

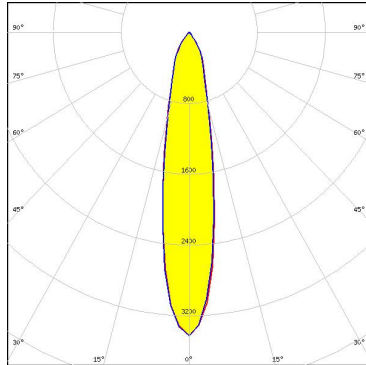
PHOTOMETRIC DATA (MEASURED):

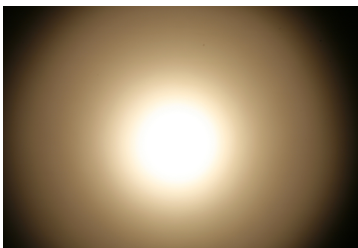
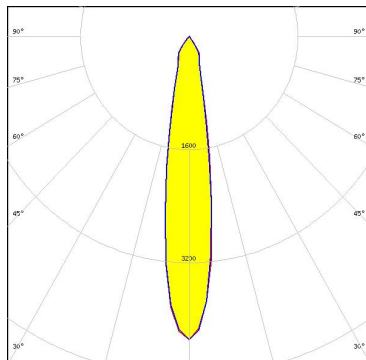
| | | |
|--|--|---|
| <p>OSRAM Opto Semiconductors</p> <p>LED Soleriq S13 FWHM 27.0° Efficiency 87 % Peak intensity 2.500 cd/lm Required components:</p> |  |  |
| <p>OSRAM Opto Semiconductors</p> <p>LED Soleriq S13 FWHM 30.0° Efficiency 83 % Peak intensity 2.100 cd/lm Required components: C12479_MIRELLA-DL</p> |  |  |
| <p>OSRAM Opto Semiconductors</p> <p>LED Soleriq S13 FWHM 28.0° Efficiency 82 % Peak intensity 2.300 cd/lm Required components: C13333_MIRELLA-CL</p> |  |  |
| <p>SEOUL SEMICONDUCTOR</p> <p>LED ZC4/6 FWHM 18.0° Efficiency 88 % Peak intensity 4.800 cd/lm Required components:</p> |  |  |

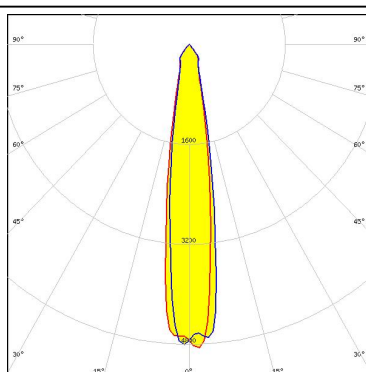
PHOTOMETRIC DATA (MEASURED):

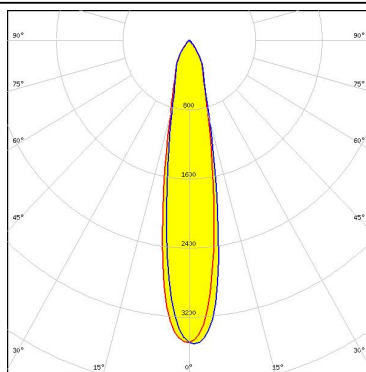
| | | |
|---|--|---|
| <p> SEOUL SEMICONDUCTOR</p> <p>LED ZC4/6 FWHM 21.0° Efficiency 83 % Peak intensity 3.400 cd/lm Required components: C12479_MIRELLA-DL</p> |  |  |
| <p> SEOUL SEMICONDUCTOR</p> <p>LED ZC4/6 FWHM 19.0° Efficiency 82 % Peak intensity 4.300 cd/lm Required components: C13333_MIRELLA-CL</p> |  |  |
| <p>SHARP</p> <p>LED Mini Zenigata (GW5BM) FWHM 17.0° Efficiency 92 % Peak intensity 4.800 cd/lm Required components:</p> |  |  |
| <p>SHARP</p> <p>LED Mini Zenigata (GW5BM) FWHM 20.0° Efficiency 86 % Peak intensity 3.500 cd/lm Required components: C12479_MIRELLA-DL</p> |  |  |

PHOTOMETRIC DATA (MEASURED):

SHARP

LED Mini Zenigata (GW6BM)
 FWHM 17.0°
 Efficiency 91 %
 Peak intensity 4.800 cd/lm
 Required components:

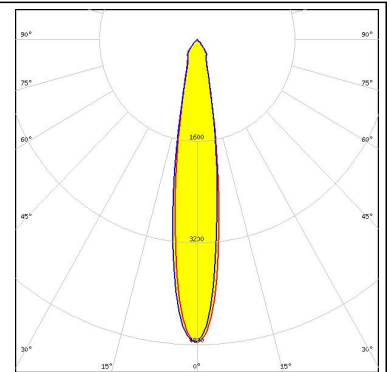
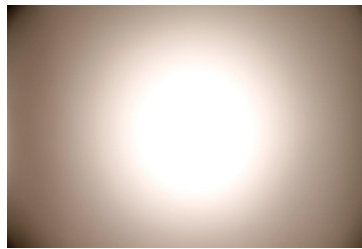

SHARP

LED Mini Zenigata (GW6BM)
 FWHM 20.0°
 Efficiency 84 %
 Peak intensity 3.200 cd/lm
 Required components:
 C12479_MIRELLA-DL

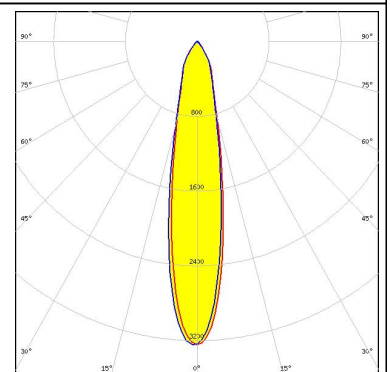
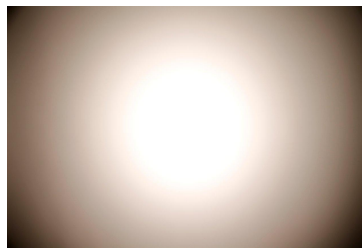

TRIDONIC

LED SLE G5 LES11
 FWHM 23.0°
 Efficiency 87 %
 Peak intensity 3.100 cd/lm
 Required components:

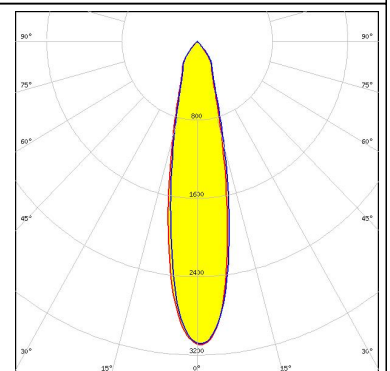
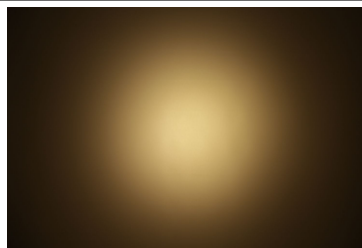

TRIDONIC

LED SLE G5 LES6
 FWHM 15.0°
 Efficiency 89 %
 Peak intensity 6.780 cd/lm
 Required components:

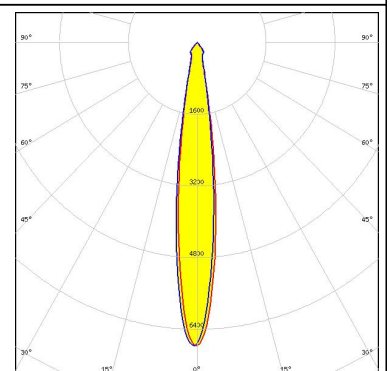
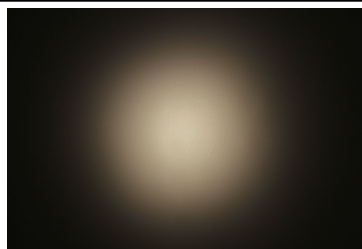

PHOTOMETRIC DATA (MEASURED):

TRIDONIC

LED STARK SLE PURE G3 LES10
FWHM 18.0°
Efficiency 82 %
Peak intensity 4.700 cd/lm
Required components:
C13333_MIRELLA-CL

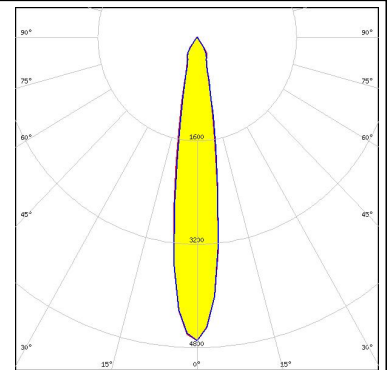

TRIDONIC

LED STARK SLE PURE G3 LES10
FWHM 17.0°
Efficiency 88 %
Peak intensity 5.000 cd/lm
Required components:

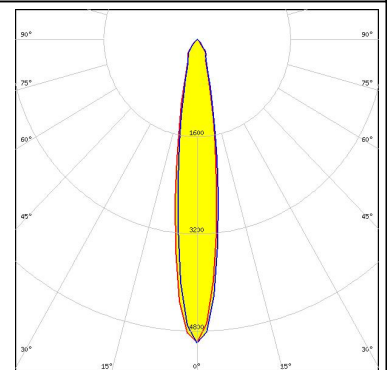

TRIDONIC

LED STARK SLE PURE G3 LES10
FWHM 20.0°
Efficiency 83 %
Peak intensity 3.800 cd/lm
Required components:
C12479_MIRELLA-DL

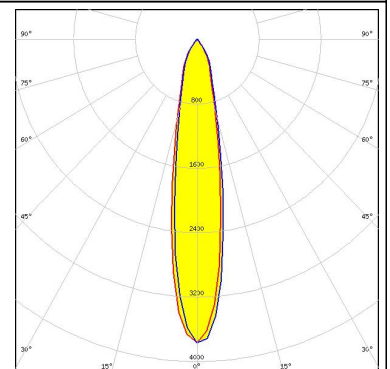
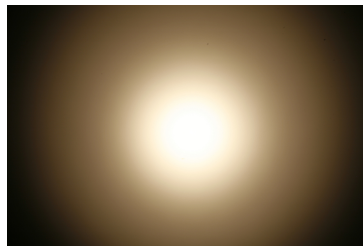

PHOTOMETRIC DATA (SIMULATED):



LED LUXEON V
 FWHM 7.7°
 Efficiency 89 %
 Peak intensity 18.700 cd/lm
 Required components:

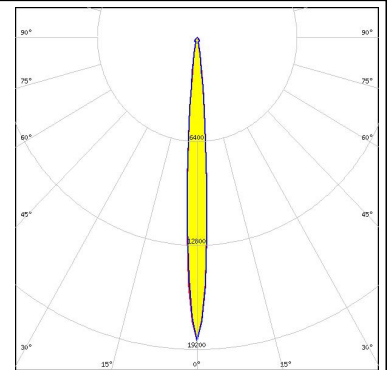

LED OSCONIQ P 7070
 FWHM 11.0°
 Efficiency 91 %
 Peak intensity 12.200 cd/lm
 Required components:

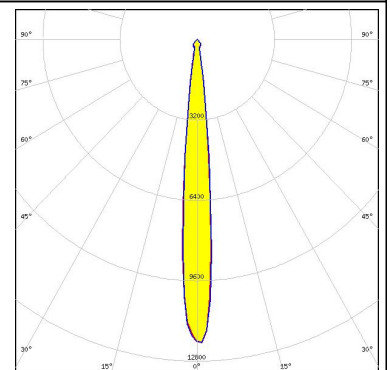

LED Soleriq S9
 FWHM 20.0°
 Efficiency 87 %
 Peak intensity 3.900 cd/lm
 Required components:
 C13333_MIRELLA-CL

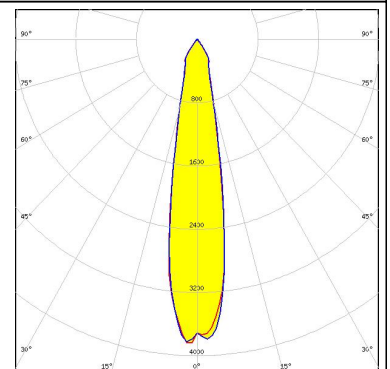

LED Soleriq S9
 FWHM 19.0°
 Efficiency 91 %
 Peak intensity 4.400 cd/lm
 Required components:

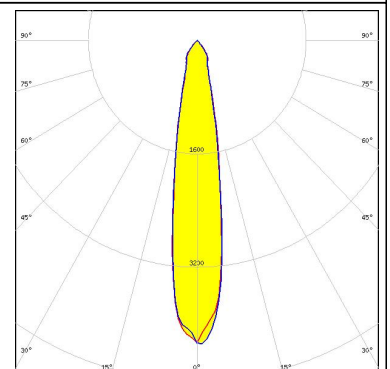

PHOTOMETRIC DATA (SIMULATED):

OSRAM
Opto Semiconductors

LED Soleriq S9
FWHM 21.0°
Efficiency 86 %
Peak intensity 3.400 cd/lm
Required components:
C12479_MIRELLA-DL

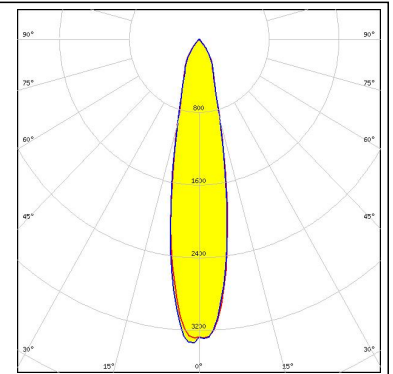

GENERAL INFORMATION:

NOTE: The typical beam angle will be changed by different color, chip size and chip position tolerance. The typical total beam angle is the full angle measured where the luminous intensity is half of the peak value.

Due to use of high power COB's with this product, special attention to proper thermal design is highly recommended. LEDiL has no liability for direct, indirect or consecutive damages arising from the LEDiL products being used outside of the recommended temperature range.

MATERIALS:

As part of our continuous research and improvement processes, and to ensure the best possible quality and availability of our products, LEDiL reserves the right to change material grades without notice.

PRODUCT DATA USER AGREEMENT AND DISCLAIMER:

The measured data in the provided downloadable LEDiL Product Datasheets and Mechanical 2D-Drawings is rounded and provided as reference for planning. LEDiL Oy's optical specifications have been verified by conducting performance testing of the products in accordance with the company's quality system. The reported data are averaged results of multiple measurements with typical variation. LEDiL Oy reserves the right to without prior notification make changes and improvements to its products.

LEDiL Oy assumes neither warranty, nor guarantee nor any other liability of any kind for the contents and correctness of the provided data. The provided data has been generated with highest diligence but the provided data may in reality not represent the complete possible variation range of all intrinsic parameters. Therefore, in certain cases a deviation from the provided data could occur.

LEDiL Oy reserves the right to undertake technical changes of its products without further notification which could lead to changes in the provided data. LEDiL Oy assumes no liability of any kind for the possible deviation from any provided data or any other damage resulting from the usage of the provided data.

The user agrees to this disclaimer and user agreement with the download or usage of the provided files.

LEDiL Oy

Joensuunkatu 13
FI-24240 SALO
Finland

LEDiL Inc.

228 West Page Street
Suite D
Sycamore IL 60178
USA

Local sales and technical support

www.ledil.com/where_to_buy

Shipping locations

Salo, Finland
Hong Kong, China

Distribution Partners

www.ledil.com/where_to_buy