

## LISA2-R-PIN

White mini reflector with ~80° wide beam. 6.5 mm high with location pin installation.

### TECHNICAL SPECIFICATIONS:

Dimensions	Ø 9.9 mm
Height	6.5 mm
Fastening	glue, pin
Colour	white
Box size	254 x 298 x 241 mm
Box weight	0 kg
Quantity in Box	10000 pcs
ROHS compliant	yes ⓘ



### MATERIAL SPECIFICATIONS:

Component	Type	Material	Colour	Coating
LISA2-R-PIN	Reflector	HRPC	white	

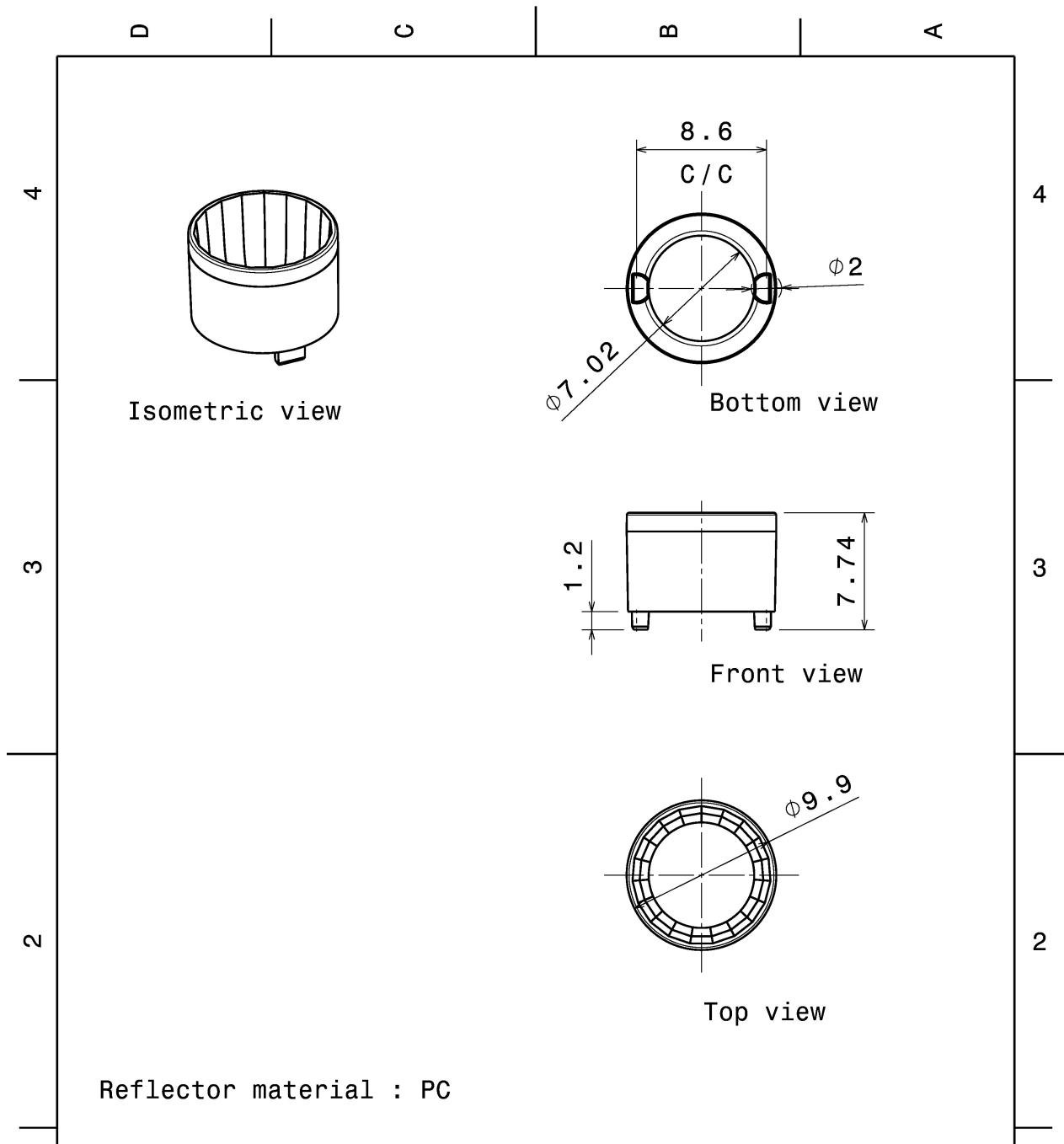

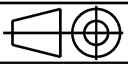
Tolerances if not otherwise shown According to DIN ISO 2768-1 Linear measures: Up to 30mm class M, otherwise class C. According to DIN ISO 2768-2 Form and position: class L		<b>LEDiL</b>		Ledil Oy Salorankatu 10 FIN 24240 SALO Finland	
THIRD ANGLE PROJECTION: 		<b>DRAWING TITLE</b> Datasheet_Lisa2-reflector			
This drawing is the property of LEDiL Oy. It may not be reproduced, copied or communicated without a written agreement with LEDiL Oy.		<b>SIZE</b> A4		<b>PART NUMBER</b> -	
		<b>SCALE</b> 3:1	<b>WEIGHT</b> -	<b>SHEET</b> 1/1	

### PHOTOMETRIC DATA (MEASURED):

#### CREE

LED XB-D  
FWHM 81.0°  
Efficiency 87 %  
Peak intensity 0.380 cd/lm  
Required components:

#### CREE

LED XP-E  
FWHM 82.0°  
Efficiency 86 %  
Peak intensity 0.350 cd/lm  
Required components:

#### CREE

LED XP-G  
FWHM 86.0°  
Efficiency 89 %  
Peak intensity 0.330 cd/lm  
Required components:

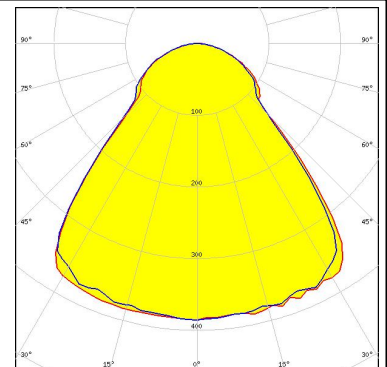

#### CREE

LED XP-G3  
FWHM 86.0°  
Efficiency 88 %  
Peak intensity 0.380 cd/lm  
Required components:

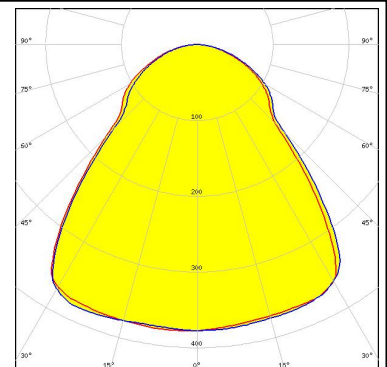
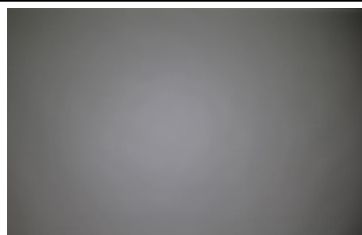

### PHOTOMETRIC DATA (MEASURED):



LED XT-E  
FWHM 80.0°  
Efficiency 85 %  
Peak intensity 0.460 cd/lm  
Required components:

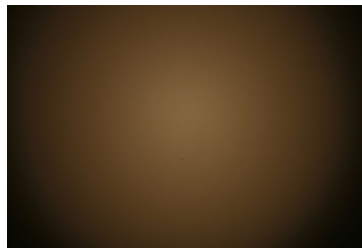

LED LUXEON A  
FWHM 83.0°  
Efficiency 88 %  
Peak intensity 0.370 cd/lm  
Required components:



LED LUXEON C  
FWHM 84.0°  
Efficiency 83 %  
Peak intensity 0.380 cd/lm  
Required components:



LED LUXEON Rebel  
FWHM 77.0°  
Efficiency 88 %  
Peak intensity 0.410 cd/lm  
Required components:

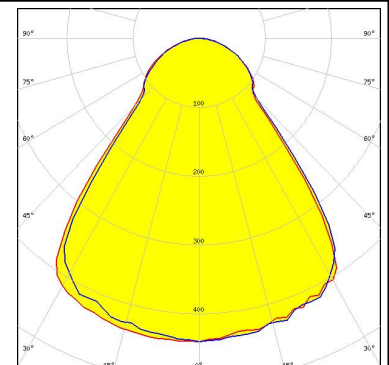
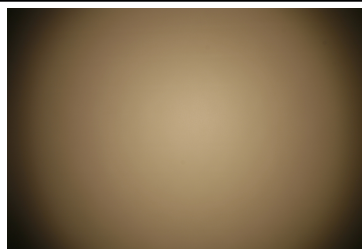

### PHOTOMETRIC DATA (MEASURED):

#### LUMILEDS

LED LUXEON Rebel ES  
FWHM 83.0°  
Efficiency 90 %  
Peak intensity 0.360 cd/lm  
Required components:

#### LUMILEDS

LED LUXEON T  
FWHM 82.0°  
Efficiency 82 %  
Peak intensity 0.400 cd/lm  
Required components:

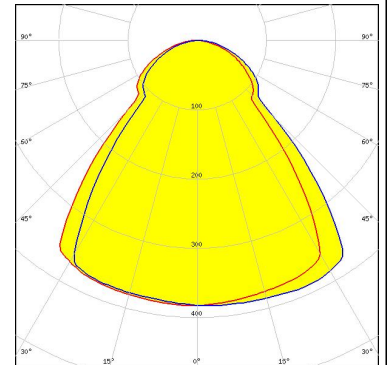
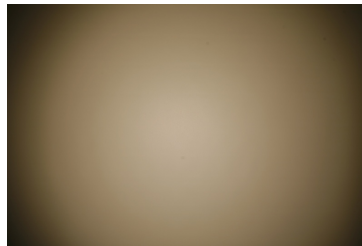

#### LUMILEDS

LED LUXEON Z  
FWHM 78.0°  
Efficiency 86 %  
Peak intensity 0.440 cd/lm  
Required components:

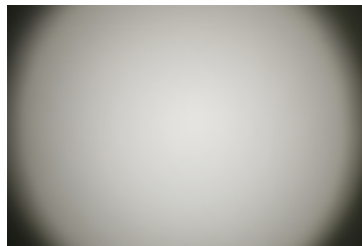

#### NICHIA

LED NCSxx19A  
FWHM 78.0°  
Efficiency 84 %  
Peak intensity 0.460 cd/lm  
Required components:

### PHOTOMETRIC DATA (MEASURED):



LED NVSxx19A  
FWHM 80.0°  
Efficiency 84 %  
Peak intensity 0.400 cd/lm  
Required components:



LED OSCONIQ P 2226  
FWHM 78.0°  
Efficiency 83 %  
Peak intensity 0.400 cd/lm  
Required components:

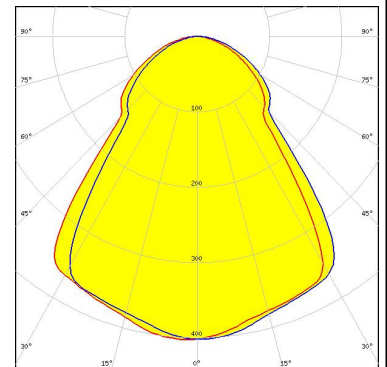
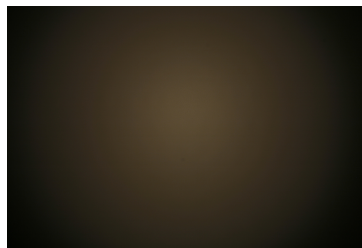



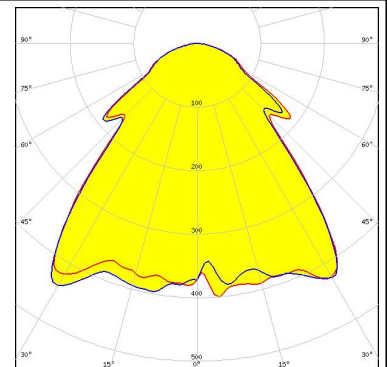
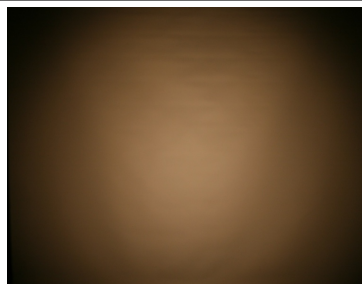

LED Oslon Square EC  
FWHM 82.0°  
Efficiency 85 %  
Peak intensity 0.370 cd/lm  
Required components:

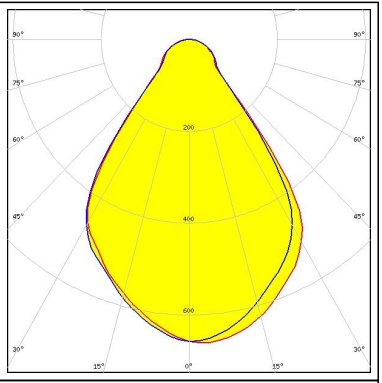
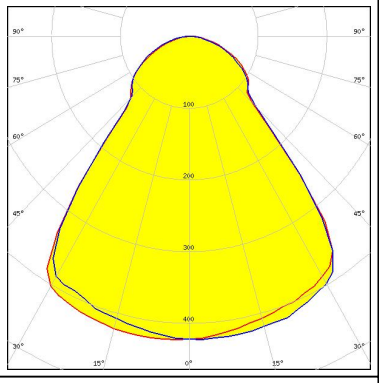

LED Oslon SSL 150  
FWHM 83.0°  
Efficiency 91 %  
Peak intensity 0.300 cd/lm  
Required components:

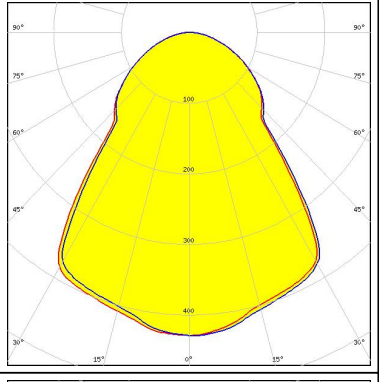
#### PHOTOMETRIC DATA (MEASURED):

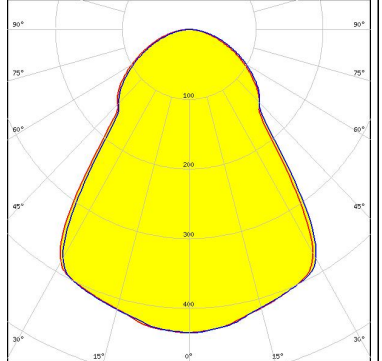
<p><b>OSRAM</b> Opto Semiconductors</p> <p>LED            Oslon SSL 80 FWHM        76.0° Efficiency    92 % Peak intensity 0.500 cd/lm Required components:</p>		
<p><b>SEOL</b> SEOUL SEMICONDUCTOR</p> <p>LED            Z5 FWHM        80.0° Efficiency    84 % Peak intensity 0.360 cd/lm Required components:</p>		
<p><b>SEOL</b> SEOUL SEMICONDUCTOR</p> <p>LED            Z8Y15 FWHM        76.0° Efficiency    87 % Peak intensity 0.430 cd/lm Required components:</p>		
<p><b>SEOL</b> SEOUL SEMICONDUCTOR</p> <p>LED            Z8Y19 FWHM        76.0° Efficiency    86 % Peak intensity 0.435 cd/lm Required components:</p>		

### PHOTOMETRIC DATA (SIMULATED):



LED XD16  
FWHM 82.0°  
Efficiency 83 %  
Peak intensity 0.360 cd/lm  
Required components:

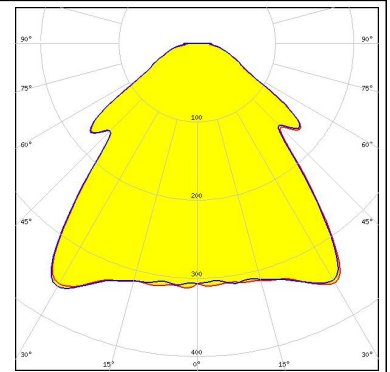

LED XHP35 HD  
FWHM 91.0°  
Efficiency 92 %  
Peak intensity 0.370 cd/lm  
Required components:

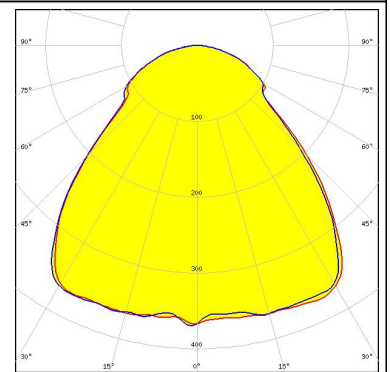

LED XP-L  
FWHM 81.0°  
Efficiency 83 %  
Peak intensity 0.360 cd/lm  
Required components:

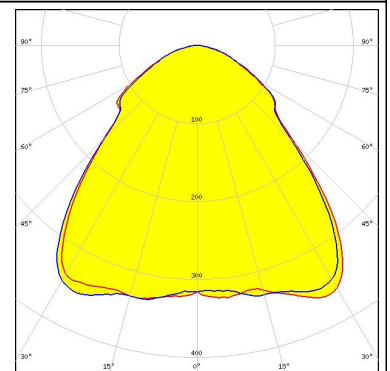

LED XQ-E  
FWHM 76.0°  
Efficiency 90 %  
Peak intensity 0.450 cd/lm  
Required components:

## PHOTOMETRIC DATA (SIMULATED):



LED LUXEON H50-2  
FWHM 80.0°  
Efficiency 90 %  
Peak intensity 0.440 cd/lm  
Required components:

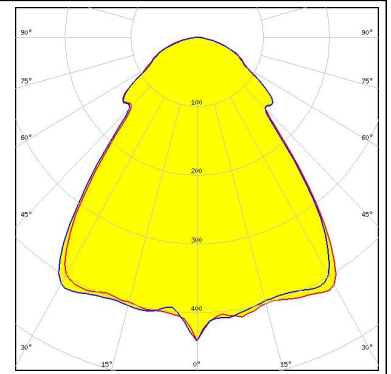

### GENERAL INFORMATION:

NOTE: The typical beam angle will be changed by different color, chip size and chip position tolerance. The typical total beam angle is the full angle measured where the luminous intensity is half of the peak value.

### MATERIALS:

As part of our continuous research and improvement processes, and to ensure the best possible quality and availability of our products, LEDiL reserves the right to change material grades without notice.

### PRODUCT DATA USER AGREEMENT AND DISCLAIMER:

The measured data in the provided downloadable LEDiL Product Datasheets and Mechanical 2D-Drawings is rounded and provided as reference for planning. LEDiL Oy's optical specifications have been verified by conducting performance testing of the products in accordance with the company's quality system. The reported data are averaged results of multiple measurements with typical variation. LEDiL Oy reserves the right to without prior notification make changes and improvements to its products.

LEDiL Oy assumes neither warranty, nor guarantee nor any other liability of any kind for the contents and correctness of the provided data. The provided data has been generated with highest diligence but the provided data may in reality not represent the complete possible variation range of all intrinsic parameters. Therefore, in certain cases a deviation from the provided data could occur.

LEDiL Oy reserves the right to undertake technical changes of its products without further notification which could lead to changes in the provided data. LEDiL Oy assumes no liability of any kind for the possible deviation from any provided data or any other damage resulting from the usage of the provided data.

The user agrees to this disclaimer and user agreement with the download or usage of the provided files.

#### LEDiL Oy

Joensuunkatu 13  
FI-24240 SALO  
Finland

#### LEDiL Inc.

228 West Page Street  
Suite D  
Sycamore IL 60178  
USA

#### Local sales and technical support

[www.ledil.com/  
where\\_to\\_buy](http://www.ledil.com/where_to_buy)

#### Shipping locations

Salo, Finland  
Hong Kong, China

#### Distribution Partners

[www.ledil.com/  
where\\_to\\_buy](http://www.ledil.com/where_to_buy)