

Fuji Duo Series Manual Motor Starters Accessories

Optional accessories

- All accessories can be used with BM3R (45 mm wide) and BM3V (55 mm wide) frames
- Accessories are easily mounted
- Internally-mountable auxiliary contact blocks and alarm contact blocks can be front mounted
- Side-mountable auxiliary contact blocks can be mounted on the left side
- Shunt trip and undervoltage trip devices are available in a wide operating coil voltage range and mount on the right side
- Standard and emergency external handles are available
- IP20 terminal cover helps prevent accidental contact with electrically charged parts
- Optional front mounted contact and alarm blocks eliminate horizontal space needed with the DIN rail

Installation of optional contact blocks and trip devices

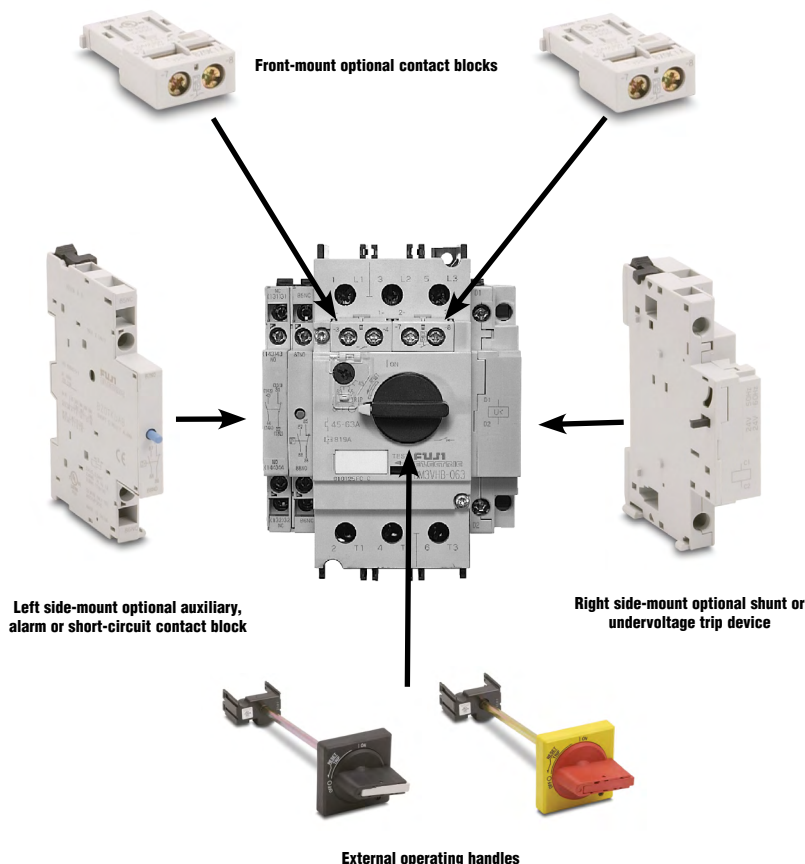

Auxiliary contact blocks

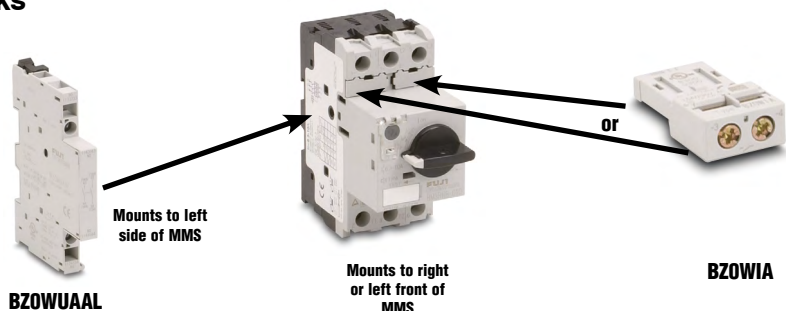

Auxiliary Contact Blocks						
Part Number	Price	Description	Starter Type	Mounting	Contact Arrangement	Weight (g/lb)
BZOWIA	\$6.00	These contact blocks do not discriminate between OFF, overload, phase-loss, or short circuit. The blocks are linked to the ON/OFF operation of the MMS, and also operate in the event of an overload, phase-loss, or short circuit. Up to two contact blocks can be mounted to the right/left front, and up to two contact blocks can be mounted to the left sides.	BM3RHB-XXX BM3VHB-XXX	Front	1NO	9/0.02
BZOWIB	\$6.00				1NC	
BZOWUAAL	\$8.50			Left side	2NO	45/0.1
BZOWUABL	\$8.50				1NO + 1NC	
BZOWUBBL	\$8.50				2NC	

Fuji Duo Series Manual Motor Starters Accessories



Accessories (continued)

Alarm contact blocks



Alarm Contact Blocks						
Part Number	Price	Description	Starter Type	Mounting	Contact Arrangement	Weight (g/lb)
BZOKIA	\$6.00	<ul style="list-style-type: none"> This block operates when the MMS trips due to overload, phase-loss, or short-circuit. It is not linked to the ON/OFF operation of the MMS. <p><i>Note: Operation can be checked with the test trip function.</i></p>	BM3RHB-XXX BM3VHB-XXX	Front (Right side only)	1NO	9/0.02
BZOKIB	\$6.00				1NC	

Auxiliary and alarm contact blocks

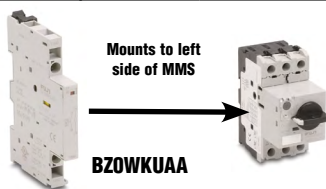

Combination Auxiliary/Alarm Contact Blocks						
Part Number	Price	Description	Starter Type	Mounting	Contact Arrangement	Weight (g/lb)
BZOWKUAA	\$10.50	<ul style="list-style-type: none"> This contact block combines an auxiliary contact and an alarm contact that operates in the event of an overload, phase loss, or short-circuit. Alarm contact is not linked to the ON/OFF operation of the MMS. An alarm is displayed in the contact block's indicator when the alarm contact operates. <p><i>Note: Operation can be checked with the test trip function.</i></p>	BM3RHB-XXX BM3VHB-XXX	Left	1NO (Aux.) + 1NO (Alarm)	45/0.1

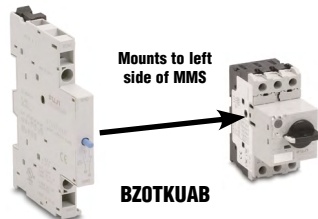

Note 1: Required when using MMS in a UL Type E application.

Note 2: Do not configure this with an auxiliary contact block; the contact will only close when a short circuit occurs.

Short-circuit alarm contact blocks

Short-Circuit Alarm Contact Block						
Part Number	Price	Description	Starter Type	Mounting	Contact Arrangement	Weight (g/lb)
BZOTKUAB	\$13.50	<ul style="list-style-type: none"> The contacts operate only when the MMS has tripped due to a short-circuit (cannot be checked with trip test function). When these contacts operate, the blue reset button extends out, and a trip indication is displayed. The power to the MMS can be turned ON after pressing the reset button. <p><i>Note: Be sure to press the reset button before mounting to the MMS.</i></p>	BM3RHB-XXX BM3VHB-XXX	Left	1NO + 1NC	45/0.1

Contact Status						
Contact Type		Device Condition				
		OFF	ON	Tripped		
				Overload or Phase-loss	Short Circuit	
AUX. CONTACT BZOWIA, BZOWIB, BZOWUAA, BZOWUBBL, BZOWUABL	NO	Open	Closed	Opens		
	NC	Closed	Open	Closes		
ALARM CONTACT BZOKIA, BZOKIB	NO	Open (no change)	Open (no change)	Closes		
	NC	Closed (no change)	Closed (no change)	Opens		
AUX & ALARM CONTACT BZOWKUAA	NO (AUX)	Open	Closed	Opens		
	NO (ALM)	Open (no change)	Open (no change)	Closes		
SHORT-CIRCUIT CONTACT BZOTKUAB	NO	Open (no change)	Open (no change)	Open (no change)	Closes	
	NC	Closed (no change)	Closed (no change)	Closed (no change)	Opens	

Fuji Duo Series Manual Motor Starters Accessories

Accessories (continued)

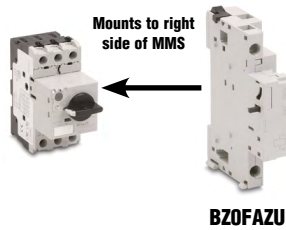

Shunt trip devices

Shunt Trip Devices						
Part Number	Price	Description	Starter Type	Mounting	Contact Arrangement	Weight (g/lb)
BZ0FAZU	\$18.00	This device is used to remotely trip the MMS.	BM3RHB-XXX BM3VHB-XXX	Right	24V 50/60Hz	115/0.25
BZ0FDZU	\$18.00	Notes: • This device cannot be used together with an undervoltage trip device. • When the MMS has been tripped with the shunt trip device, press the reset button before turning ON the power.			110-127V 50Hz/120V 60Hz	
BZ0FKZUD	\$18.00				24-60VDC (time rating of coil is 5s)	

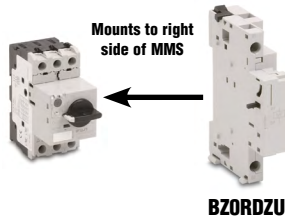

Undervoltage trip devices

Undervoltage Trip Devices						
Part Number	Price	Description	Starter Type	Mounting	Contact Arrangement	Weight (g/lb)
BZ0RAZ2U	\$18.00	This device automatically trips the MMS when the control circuit voltage drops below the specified value. Notes: This device cannot be used together with a shunt trip device. When the MMS has been tripped with the undervoltage trip device, press the reset button before turning ON the power.	BM3RHB-XXX BM3VHB-XXX	Right	24V 60Hz	115/0.25
BZ0RDZU	\$18.00				110-127V 50Hz/120V 60Hz	
BZ0R4ZU	\$18.00				415-440V 50Hz/460-480V 60Hz	



Push-in lug

Push-in Lug				
Part Number	Price	Description	Starter type	Weight (g/lb)
BZ0SET	\$6.00	Push-in mounting lug. Required for screw mounting of MMS; qty: 10/pkg	BM3RHB-XXX	2.0/.004
<i>Note: See page MRC-54 for installation instructions</i>				



Terminal Cover

Terminal Cover			
Part Number	Price	Description	Starter Type
BZ0TCRE	\$10.50	Line side terminal cover.	BM3RHB-XXX
Notes: BZ0TCRE required only when using BM3RHB-xxx MMS in a UL Type E application (along with short circuit alarm contact block BZ0TKUAB). If using BZ0TCRE terminal cover with BM3R series MMS, the busbar system and front mounted contacts cannot be used.			

Fuji Duo Series Manual Motor Starters Accessories

Accessories (continued)

External operating handles



BZ0VBBL

BZ0VYRL

External Operating Handles					
Part Number	Price	Description	Starter Type	Handle Type	Weight (g/lb)
BZ0VBBL	\$27.00	<ul style="list-style-type: none"> Used to operate an MMS installed inside a panel, from the outside of the panel. Equipped with an interlock mechanism that prevents someone from mistakenly opening the panel door when the MMS is in the ON state. The shaft can be cut to match the distance between the MMS and the panel door. Door interlock function OFF lock function Can be locked OFF with up to three padlocks. Note: Padlocks are to be provided by the customer. Release screw allows the door to be opened with the handle in the ON position. IP54 enclosure 	BM3RHB-XXX	Standard (black)	160/0.35
BZ0VYRL	\$28.50			Emergency (red/yellow)	160/0.35
BZ0VBBM	\$27.00		BM3VHB-XXX	Standard (black)	160/0.35
BZ0VYRM	\$28.50			Emergency (red/yellow)	160/0.35

NOTE: Premade MMS enclosures are currently not available.

Accessory specifications

Trip Device Specifications			
Accessory Type and Part Number		Shunt trip device	Undervoltage device
		BZ0Fxxx	BZ0Rxxx
Standard		IEC 60947-1, UL 508	
Rated Insulation Voltage (VAC)	IEC 60947	690	
	UL 508	600	
No. of ON-OFF Operations		5000	
Operating Time (ms)		20	
Power Consumption	Inrush (VA/W)	21/12	
	Sealed (VA/W)	8/1.2	
Voltage Range	Tripping Voltage (V)	0.7 to 1.1 Ue	0.35 to 0.7 Ue
	Closing Voltage (V)	-	0.85 to 1.1 Ue
Time Rating of Coil (s)		AC: Continuous	AC: Continuous
		DC: 5	

Fuji Duo Series Manual Motor Starters Accessories

Accessory specifications (continued)

Contact Block Specifications						
Accessory Type and Part Number		Auxiliary contact block/front	Auxiliary contact block/side	Alarm contact block	Aux. and alarm contact block	Short-circuit alarm contact block
		BZOWIA, BZOWIB <i>(note 3)</i>	BZOWUAAAL, BZOWUABL, BZOWUBBL	BZOKIA, BZOKIB <i>(note 3)</i>	BZOWKUAA	BZOTKUAB
Standard		IEC 60947-5-1, UL 508				
Rated Operational Current (A)	48VAC AC-15 <i>(note 2)</i>	5	6	5	6	6
	125VAC	3	4	3	4	4
	230VAC	1.5	4	1.5	4	4
	400VAC	<i>(note 3)</i>	2.2	<i>(note 3)</i>	2.2	2.2
	500VAC		1.5		1.5	
	690VAC		0.6		0.6	
	48VDC DC-13 <i>(note 2)</i>	1.38	5	1.38	5	5
	110VDC	0.55	1.3	0.55	1.3	1.3
220VDC	0.27	0.5	0.27	0.5	0.5	
Contact Rating Code UL 508 <i>(note 1)</i>	AC	B300	A600	B300	A600	A600
	DC	Q300	P300	Q300	P300	P300
Min. Voltage and Current		17V / 5mA				
<p>Note 1: NEMA ICS 5-2000. For more information, refer to Control Circuit Contact Electrical Ratings, page MRC-111.</p> <p>Note 2: IEC utilization category. For more information, refer to page MRC-112.</p> <p>Note 3: The indicated contacts should not be used in control circuits higher than 300V.</p>						

Dimensions (mm)

Manual motor starters

Rotary handle types BM3RHB-xxx

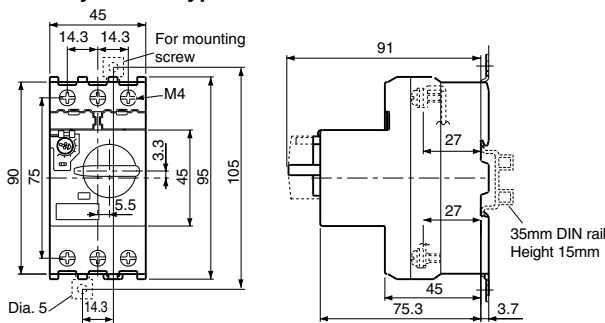

Rotary handle types BM3VHB-xxx

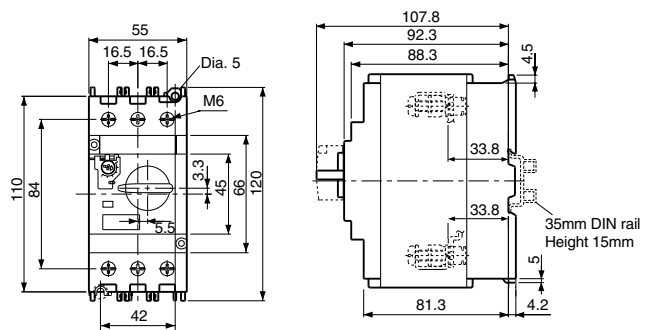

Fuji Duo Series Manual Motor Starters Accessories



Dimensions (continued - mm)

Accessories

**Auxiliary contact blocks, front mounting
BZ0WIA, BZ0WIB**

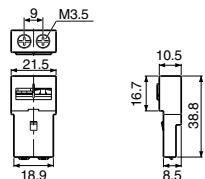

**Auxiliary contact blocks, side mounting
BZ0WUAAL, BZ0WUABL, BZ0WUBBL**

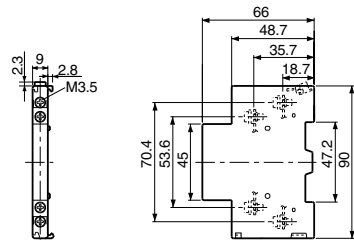

**Alarm contact blocks, front mounting
BZ0KIA, BZ0KIB**

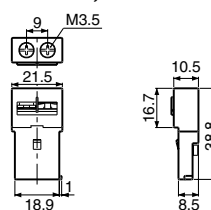

**Auxiliary and alarm contact blocks
BZ0WKUAA**

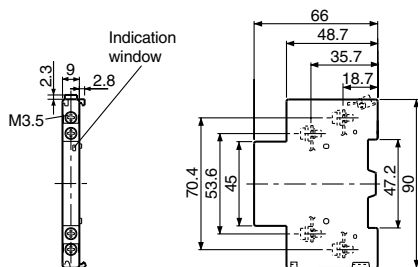

**Short-circuit alarm contact block
BZ0TKUAB**

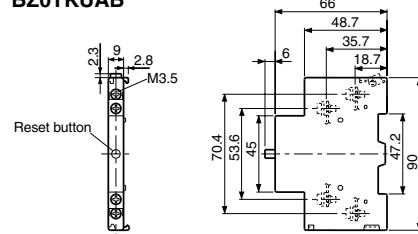

**Shunt trip devices BZ0Fxxxx
Undervoltage trip devices BZ0Rxxxx**

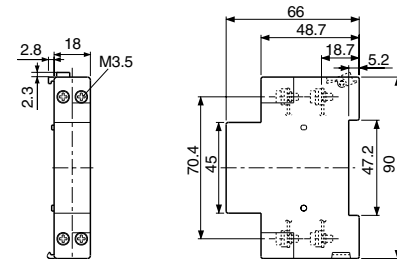

MMS with accessories

BM3RHB-xxx + BZ0xxxxx

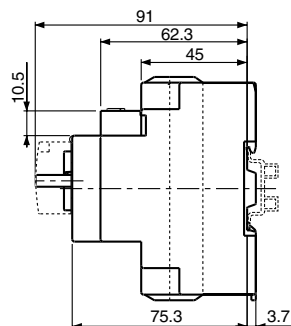
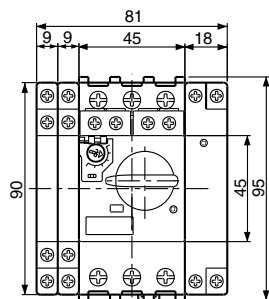

BM3VHB-xxx + BZ0xxxxx

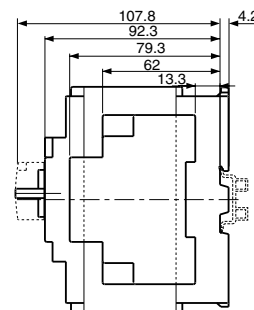
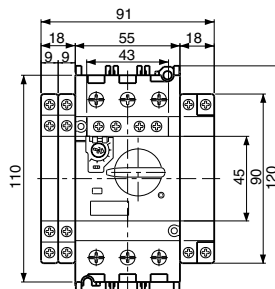

Fuji Duo Series Manual Motor Starters Accessories



Dimensions (continued - mm)

Accessories

External operation handle BZ0Vxxx

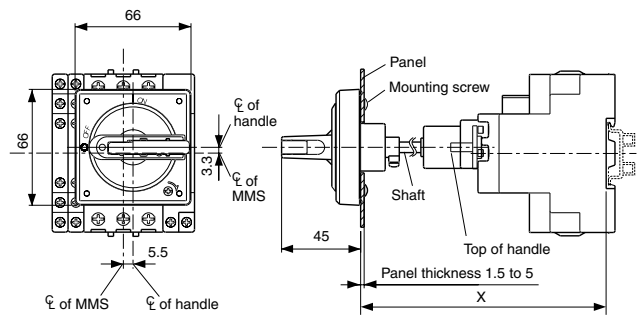

Type	X min.	X max.
BZ0VBBL, BZ0VYRL	139 ±2	289 ±2
BZ0VBBL, BZ0VYRM	156 ±2	306 ±2

Panel drilling

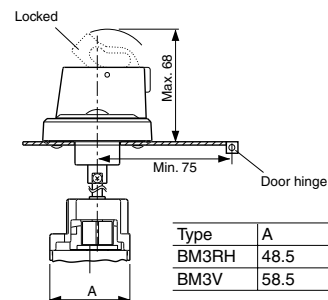
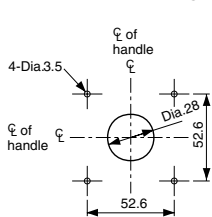

Type	A
BM3RH	48.5
BM3V	58.5

MMS

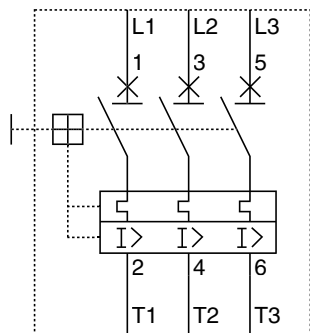

Auxiliary and alarm contact blocks BZ0WKUAA

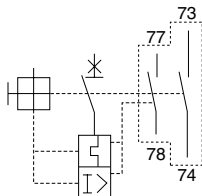

Alarm contact blocks

Front mounting

BZ0KIA

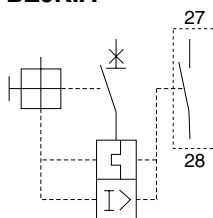

BZ0KIB

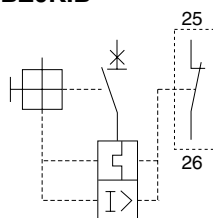

Fuji Duo Series Manual Motor Starters Accessories

Wiring diagrams (continued)

Auxiliary contact blocks

Front mounting

BZ0WIA

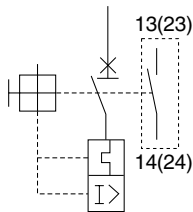

BZ0WIB

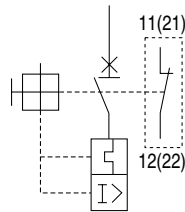

Side mounting

BZ0WUAAL

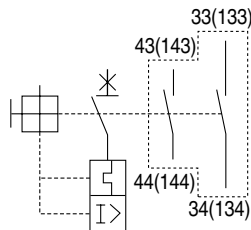

BZ0WUABL

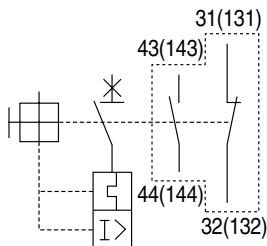

BZ0WUBBL

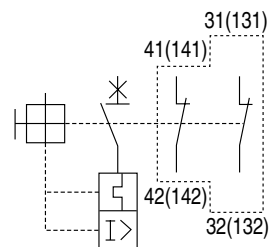

Short-circuit alarm contact blocks

BZ0TKUAB

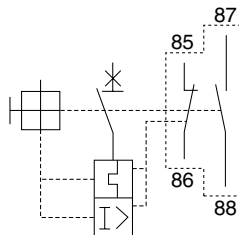

Shunt trip devices

BZ0Fxxxx

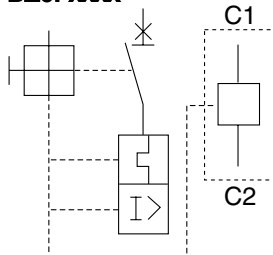

Undervoltage trip devices

BZ0Rxxxx

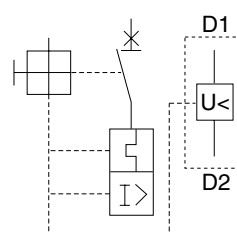

Fuji Duo Series Manual Motor Starters Accessories

Busbar system

Features

- The busbar system reduces wiring time and saves floor space.
- The busbar makes it easy to power from 2 to 5 manual motor starters, with no wiring needed.
- The 3-phase feed-in terminals are used to connect the wire for the power supply circuit.
- The busbar cover guards against accidental touching of nonconnected busbar terminals (charged parts).
- If using BZ0TCRE terminal cover with BM3R series MMS, the busbar system can not be used.

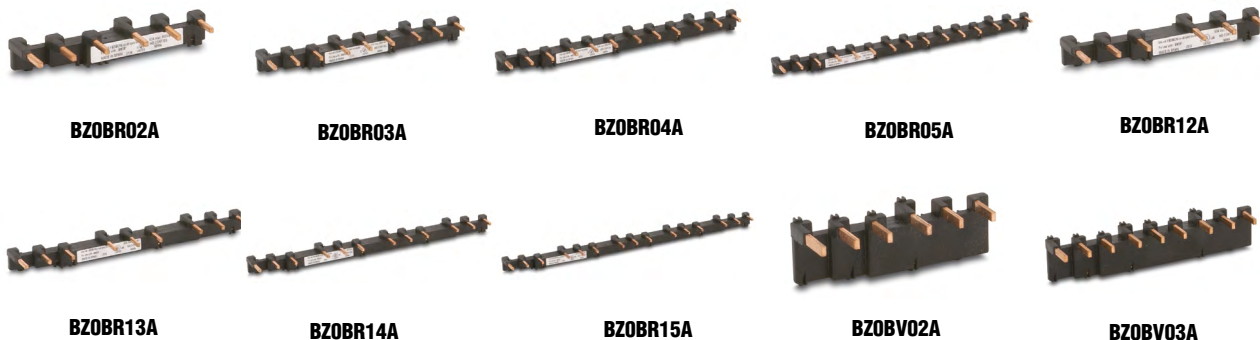
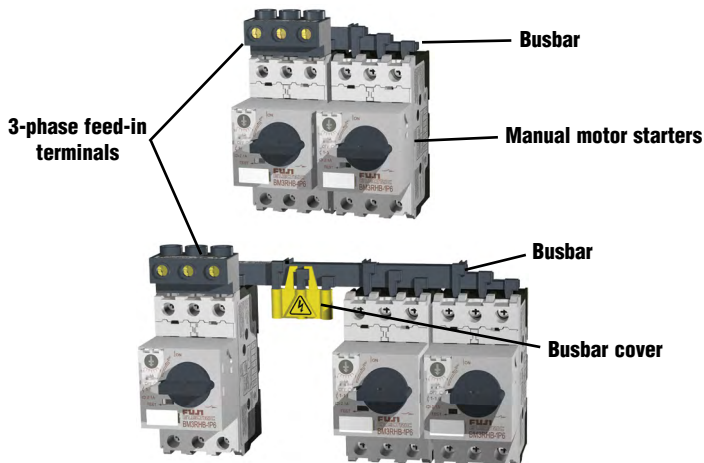

Note: Busbar photos continued on next page.



BZ0BFRA



BZ0BFVA



BZ0BCRA



BZ0BCVA

Busbar System Components and Ratings							
Part Number	Price	Description	Used with	Specifications	Weight (g)		
BZ0BR02A	\$16.00	Busbar	BM3R	Continuous current: 64A max. pin connection	2-BM3R, modular space: 45mm	30	
BZ0BR03A	\$14.50				3-BM3R, modular space: 45mm	50	
BZ0BR04A	\$17.00				4-BM3R, modular space: 45mm	70	
BZ0BR05A	\$18.00				5-BM3R, modular space: 45mm	90	
BZ0BR12A	\$13.50				2-BM3R, modular space: 54mm	30	
BZ0BR13A	\$16.00		BM3R+ 1 external accessory, 9mm wide		3-BM3R, modular space: 54mm	55	
BZ0BR14A	\$18.00				4-BM3R, modular space: 54mm	80	
BZ0BR15A	\$19.50				5-BM3R, modular space: 54mm	105	
BZ0BV02A	\$26.00		BM3V		Continuous current: 126A max. pin connection	2-BM3V, modular space: 55mm	140
BZ0BV03A	\$33.00					3-BM3V, modular space: 55mm	240
BZ0BV04A	\$39.00					4-BM3V, modular space: 55mm	340
BZ0BV12A	\$28.50					2-BM3V, modular space: 64mm	150
BZ0BV13A	\$35.50				BM3V + 1 external accessory, 9mm wide	3-BM3V, modular space: 64mm	270
BZ0BV14A	\$41.00					4-BM3V, modular space: 64mm	380
BZ0BFRA	\$14.50	3-phase feed-in terminal		BM3R		Continuous current: 64A max. Applicable cable size: 25mm ² max.	40
BZ0BFVA	\$29.50			BM3V		Continuous current: 126A max. Applicable cable size: 50mm ² max.	170
BZ0BCRA	\$4.00	Busbar cover	BZ0BR	For pin connection	10		
BZ0BCVA	\$4.75		BZ0BV	NOTE: Some fine tuning and fitting adjustments may be needed.	5		

Fuji Duo Series Manual Motor Starters Accessories

Busbar system (continued)

Dimensions (mm)



BZ0BV04A



BZ0BV12A



BZ0BV13A



BZ0BV14A

For BM3RHB-xxx

BZ0BR0xx Without external accessory

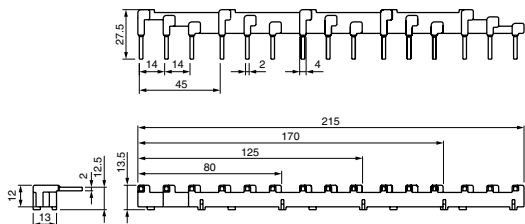

- BZ0BR02A: 80 mm
- BZ0BR03A: 125 mm
- BZ0BR04A: 170 mm
- BZ0BR05A: 215 mm

For BM3VHB-xxx

BZ0BV0xx Without external accessory

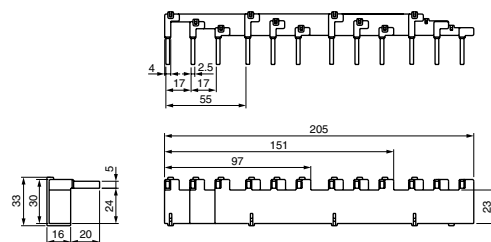

- BZ0BV02A: 97 mm
- BZ0BV03A: 151 mm
- BZ0BV04A: 205 mm

BZ0BR1xx With 1 external accessory

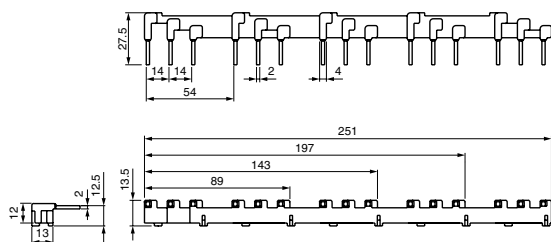

- BZ0BR12A: 89 mm
- BZ0BR13A: 143mm
- BZ0BR14A: 197 mm
- BZ0BR15A: 251 mm

BZ0BV1xx With 1 external accessory, 9mm wide

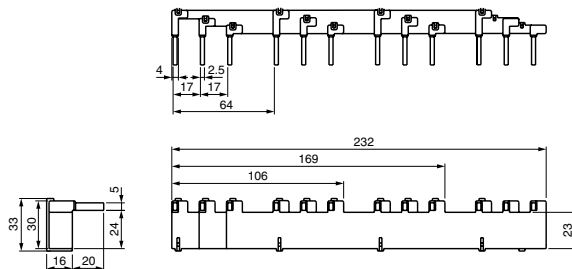

- BZ0BV12A: 106 mm
- BZ0BV13A: 169 mm
- BZ0BV14A: 232 mm

BZ0BFRA 3-phase feed-in terminals

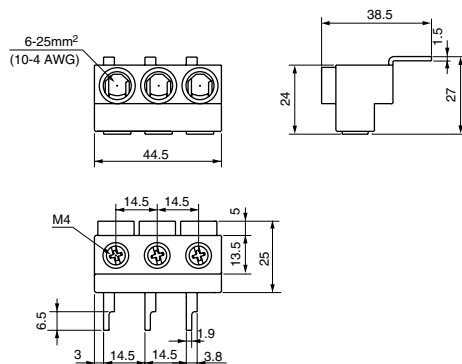

BZ0BFVA

