

BI10-M30-LIU

Inductive Sensor – With Analog Output

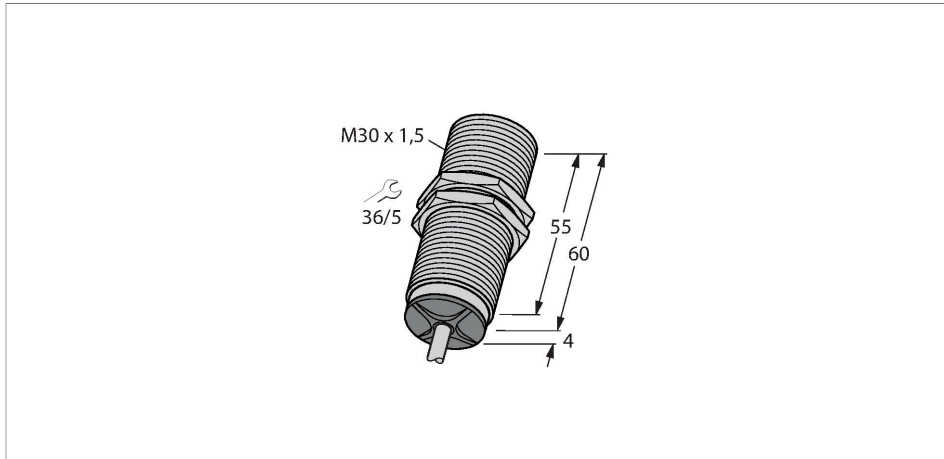

Features

- M30 × 1.5 threaded tube
- Chrome-plated brass
- 4-wire, 15...30 VDC
- Analog output
- 0...10 V and 0...20 mA
- Cable connection

Wiring diagram

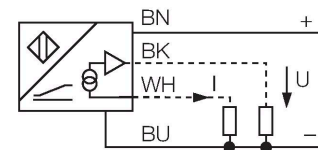

Technical data

Type	BI10-M30-LIU
ID	15355
General data	
Measuring range	3...8 mm
Mounting conditions	Flush
Secured operating distance	$\leq (0.81 \times S_n)$ mm
Correction factors	St37 = 1; Al = 0.3; stainless steel = 0.7; Ms = 0.4
Repeatability	$\leq 1\%$ of measuring range A - B
	0.5 %, after warm-up 0.5 h
Reproducibility	$\leq 50\ \mu\text{m}$
	$\leq 25\ \mu\text{m}$, after a warm-up time of 0.5 h
Linearity deviation	$\leq 3\%$
Temperature drift	$\leq \pm 0.06\%$ / K
Electrical data	
Operating voltage	15...30 VDC
Residual ripple	$\leq 10\%$ U_{ss}
No-load current	8 mA
Isolation test voltage	$\leq 0.5\ \text{kV}$
Short-circuit protection	yes
Wire breakage/Reverse polarity protection	no / Complete
Output function	4-wire, Analog output
Voltage output	0...10 V
Current output	0...20 mA

Functional principle

Inductive TURCK sensors with analog output accomplish simple control tasks. They provide a current, voltage or frequency signal proportional to the target's distance. The output signal is linear to the distance of the target over the entire sensing range.

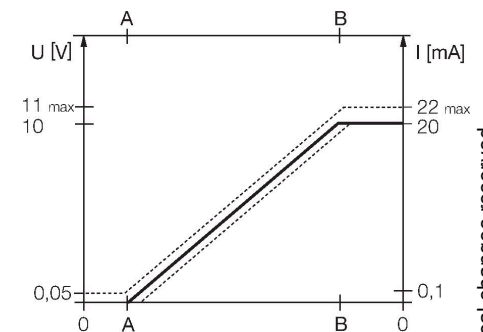

BI10-M30-LIU | 11/29/2022 05-17 | technical changes reserved

Technical data

Load resistance voltage output	$\geq 4.7 \text{ k}\Omega$
Load resistance current output	$\leq 0.4 \text{ k}\Omega$
Measuring sequence frequency	140 Hz
Mechanical data	
Design	Threaded barrel, M30 × 1.5
Dimensions	64 mm
Housing material	Metal, CuZn, Chrome-plated
Active area material	Plastic, PA12-GF30
End cap	Plastic, EPTR
Max. tightening torque of housing nut	75 Nm
Electrical connection	Cable
Cable quality	Ø 5.2 mm, Gray, LifYY, PVC, 2 m
Core cross-section	4 x 0.34 mm ²
Environmental conditions	
Ambient temperature	-25...+70 °C
Vibration resistance	55 Hz (1 mm)
Shock resistance	30 g (11 ms)
Protection class	IP67
MTTF	751 years acc. to SN 29500 (Ed. 99) 40 °C

Mounting instructions

Mounting instructions/Description



Distance D 60 mm

Distance W 27 mm

Distance T 3 x B

Distance S 45 mm

Distance G 54 mm

Diameter active area B \varnothing 30 mm

Accessories

BST-30B

6947216

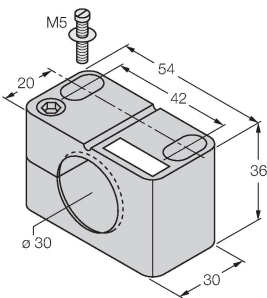

Mounting clamp for threaded barrel sensors, with dead-stop; material: PA6

QM-30

6945103

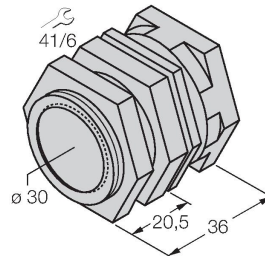

Quick-mount bracket with dead-stop; material: Chrome-plated brass. Male thread M36 x 1.5. Note: The switching distance of the proximity switches may change when using quick-mount brackets.

MW-30

6945005

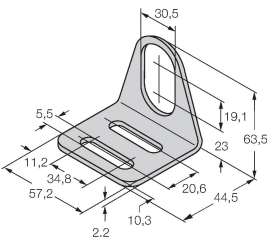

Mounting bracket for threaded barrel sensors; material: Stainless steel A2 1.4301 (AISI 304)

BSS-30

6901319

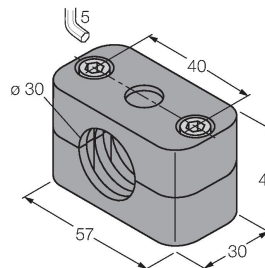

Mounting clamp for smooth and threaded barrel sensors; material: Polypropylene