



Wire Protection & Management > Interconnect Devices > SolderSleeve Shield Terminators



Operating Temperature (Max): 125 °C

Expanded Inside Diameter (Min): 3 mm [.118 in]

Recovered Inside Diameter (Max): 2.49 mm [.098 in]

Pre-Installed Lead: No

Wire Temperature (Max): 85 °C

### Features

#### Configuration Features

Pre-Installed Lead	No
--------------------	----

#### Dimensions

Expanded Inside Diameter (Min)	3 mm [.118 in]
Recovered Inside Diameter (Max)	2.49 mm [.098 in]

#### Usage Conditions

Operating Temperature (Max)	125 °C
Wire Temperature (Max)	85 °C

### Product Compliance

[For compliance documentation, visit the product page on TE.com>](#)

EU RoHS Directive 2011/65/EU	Not Compliant
EU ELV Directive 2000/53/EC	Not Compliant
China RoHS 2 Directive MIIT Order No 32, 2016	Restricted Materials Above Threshold
EU REACH Regulation (EC) No. 1907/2006	Current ECHA Candidate List: JUNE 2024 (241) Candidate List Declared Against: JAN 2024 (240) SVHC > Threshold: Cd (18% in Solder) Pb (32% in Solder) <small>Article Safe Usage Statements:</small>



Use personal protective equipment as required. Do not eat, drink or smoke when using this product. Wash thoroughly after handling. Recycle if possible and dispose of the article by following all applicable governmental regulations relevant to your geographic location.

Halogen Content

Low Halogen - Br, Cl, F, I < 900 ppm per homogenous material. Also BFR/CFR/PVC Free

Solder Process Capability

Not applicable for solder process capability

Product Compliance Disclaimer

This information is provided based on reasonable inquiry of our suppliers and represents our current actual knowledge based on the information they provided. This information is subject to change. The part numbers that TE has identified as EU RoHS compliant have a maximum concentration of 0.1% by weight in homogenous materials for lead, hexavalent chromium, mercury, PBB, PBDE, DBP, BBP, DEHP, DIBP, and 0.01% for cadmium, or qualify for an exemption to these limits as defined in the Annexes of Directive 2011/65/EU (RoHS2). Finished electrical and electronic equipment products will be CE marked as required by Directive 2011/65/EU. Components may not be CE marked. Additionally, the part numbers that TE has identified as EU ELV compliant have a maximum concentration of 0.1% by weight in homogenous materials for lead, hexavalent chromium, and mercury, and 0.01% for cadmium, or qualify for an exemption to these limits as defined in the Annexes of Directive 2000/53/EC (ELV). Regarding the REACH Regulation, the information TE provides on SVHC in articles for this part number is based on the latest European Chemicals Agency (ECHA) 'Guidance on requirements for substances in articles' posted at this URL: <https://echa.europa.eu/guidance-documents/guidance-on-reach>

## Compatible Parts



TE Part # EG8162-000  
HL1920E-230V-EURO

## Customers Also Bought

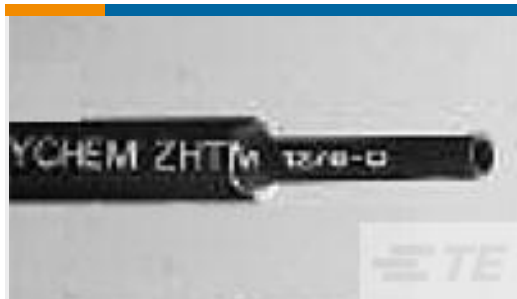

TE Part #2450984003  
ZHTM-40/20-0-SP

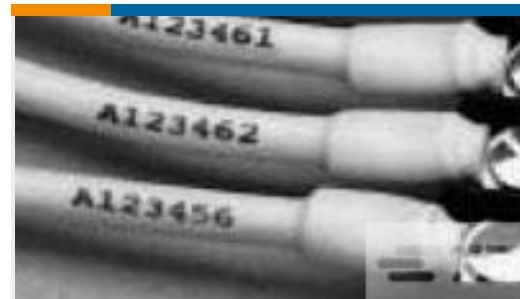

TE Part #5070024018  
RNF-100-1/16-X-SP

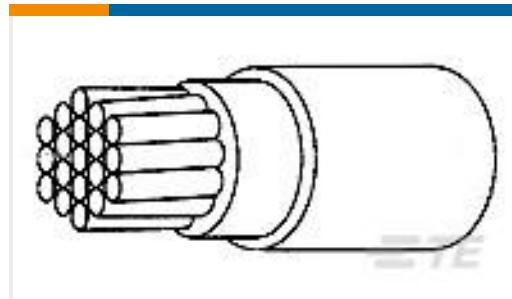

TE Part #8126873001  
99M0111-12-1

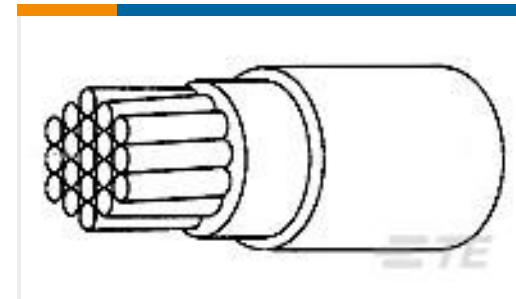

TE Part #4589973001  
99M0111-16-2

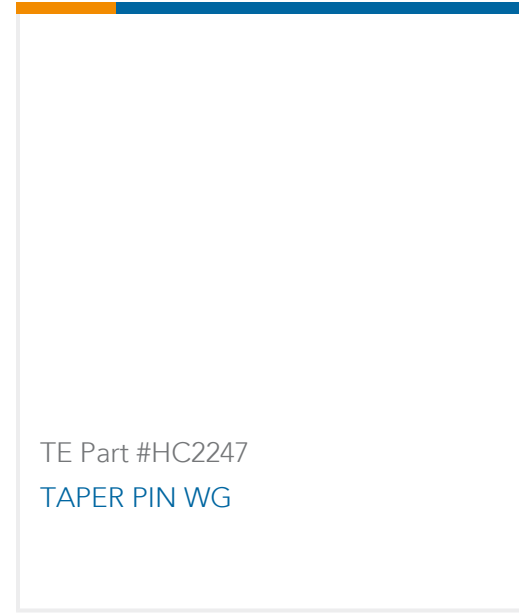
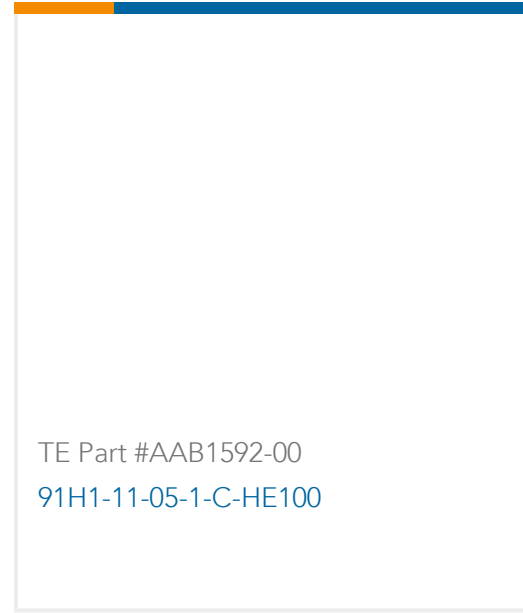
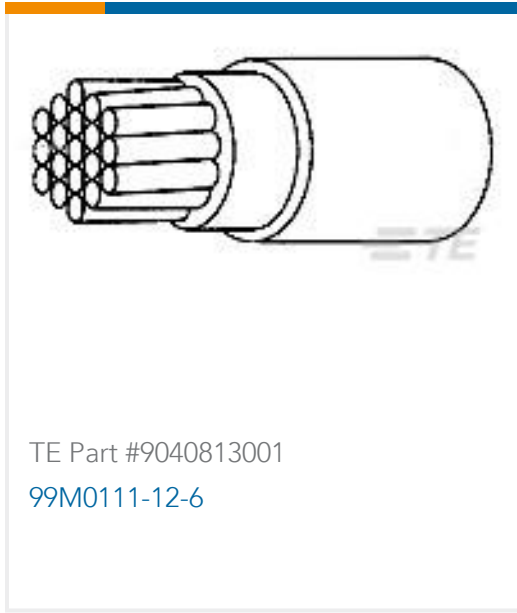

## Documents

### Product Drawings

[B-150-03](#)

English

---

### Product Specifications

[Product Specification](#)

English