

A765, Polymer Aluminum, 560 uF, 20%, 2.5 VDC, -55/+105°C

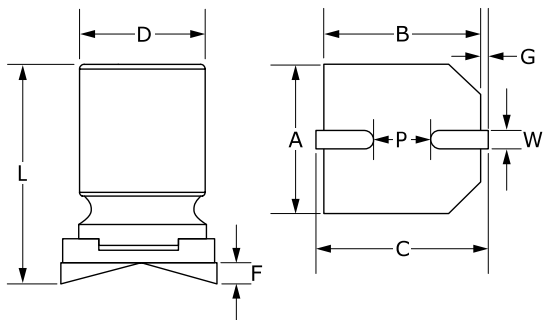

Dimensions	
D	6.3mm +/-0.5mm
L	8mm +/-0.3mm
W	0.5 - 0.8mm
F	0.2mm MAX
A	6.6mm +/-0.2mm
B	6.6mm +/-0.2mm
C	7.3mm +/-0.2mm
G	0.35mm +/-0.2mm
P	2.1mm +/-0.2mm

Packaging Specifications	
Packaging:	T&R, 380mm
Packaging Quantity:	1000

General Information	
Series:	A765
Dielectric:	Polymer Aluminum
Style:	SMD Can
Description:	Surface Mount, Polymer Aluminum
RoHS:	Yes
Lead:	V-Chip
AEC-Q200:	No

Specifications	
Capacitance:	560 uF
Capacitance Tolerance:	20%
Voltage DC:	2.5 VDC, 2.9 VDC (Surge)
Temperature Range:	-55/+105°C
Rated Temperature:	105°C
Life:	2000 Hrs
Resistance:	20 mOhms (100kHz 20C)
ESR/Impedance at 100kHz:	20 mOhms
Ripple Current:	3200 mAmps (100kHz 105C)
Leakage Current:	300 uA (2min 20°C)
High Temperature Solder:	No