

KEMET Part Number: A72MF0470AA00J
(72MF0470AA00J)

KEMET
a YAGEO company

A72, Film, Film/Foil Polypropylene, General Purpose, 470 pF, 5%, 160 VAC, 400 VDC, 85°C

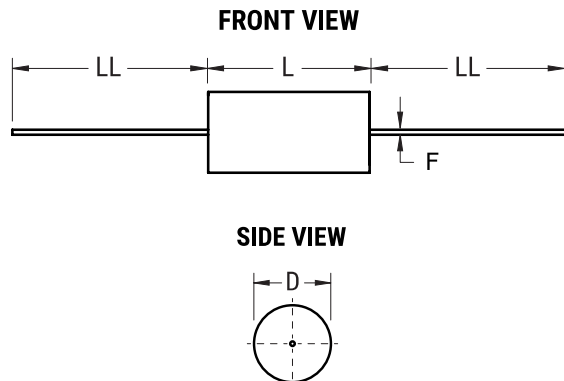

Dimensions	
D	5mm MAX
L	11mm MAX
LL	40mm +/-5mm
F	0.5mm +/-0.05mm

Packaging Specifications	
Packaging:	Bulk, Bag
Packaging Quantity:	1500

General Information	
Series:	A72
Dielectric:	Film/Foil Polypropylene
Style:	Axial
RoHS:	No
Prop 65:	 WARNING: Cancer and reproductive harm - www.p65warnings.ca.gov .
SCIP Number:	9e4e6835-cc7d-4906-b899-eb756f795e06
Lead:	Wire Leads
AEC-Q200:	No
Miscellaneous:	Above 85C DC And AC Voltage Derating Is 1.25%/C. maxK0 = 10000000.

Specifications	
Capacitance:	470 pF
Capacitance Tolerance:	5%
Voltage AC:	160 VAC
Voltage DC:	400 VDC, 300 VDC (105C)
Temperature Range:	-55/+105°C
Rated Temperature:	85°C
Dissipation Factor:	0.05% 10kHz, 0.1% 100kHz
Insulation Resistance:	100 GOhms
Max dV/dt:	13000 V/us
Inductance:	11 nH

Statements of suitability for certain applications are based on our knowledge of typical operating conditions for such applications, but are not intended to constitute - and we specifically disclaim - any warranty concerning suitability for a specific customer application or use. This Information is intended for use only by customers who have the requisite experience and capability to determine the correct products for their application. Any technical advice inferred from this Information or otherwise provided by us with reference to the use of our products is given gratis, and we assume no obligation or liability for the advice given or results obtained.

KEMET
a YAGEO company